

CONF-770656--10

PERIMETER INTRUSION DETECTION  
AND ASSESSMENT SYSTEM\*

M. J. Eaton  
J. Jacobs  
D. E. McGovern

Sandia Laboratories, Albuquerque, N. M. 87115

NOTICE  
This report was prepared as an account of work sponsored by the United States Government. Neither the United States nor the United States Energy Research and Development Administration, nor any of their employees, makes any warranty, express or implied, or assumes any legal liability or responsibility for the accuracy, completeness, or usefulness of any information, apparatus, product, or process disclosed, or represents that its use would not infringe privately owned rights.

**MASTER**

Preface

In response to the nation's continuing program of keeping nuclear facilities' safeguards current with postulated threats and available technology, many sites are involved in defining and implementing systems to upgrade their security posture. As a result of this activity, many papers have been presented at this and other conferences on integrated system concepts, performance and vulnerability evaluation techniques and security hardware. This block of three papers will be devoted to discussing how these concepts, techniques, and hardware were used to upgrade one aspect of physical security at a particular site. The specific topic to be considered is the design and implementation of a Perimeter Intrusion Detection and Assessment System at a relatively large materials storage site. The key elements of this system are (1) Intrusion Sensors, (2) Alarm Assessment, and (3) System Control and Display.

A detailed system study was conducted at this facility to determine its vulnerability to a spectrum of threats. From this study a series of security options were defined which employ different combinations of technology and security personnel to accomplish the detection, delay, and response roles. A system was then designed that best suited the available resources. In addition to the detection and assessment elements discussed in these papers, upgrades in the delay and response areas are also in progress.

The goal of this program was to design, develop, and install a perimeter intrusion detection and assessment system in one year starting July 15, 1976. This short time scale restricted the equipment that could be utilized to simple modification of proven off-the-shelf hardware. Heavy spring rains during the sensor installation phase have proven to be the most serious obstacle to meeting the original schedule.

The site under discussion is located in the southern Great Plains and is surrounded by relatively flat agricultural lands. The protected area was reduced to include only SNN associated activities and has a perimeter length of approximately

\* This work was supported by the U. S. Energy Research and Development Administration

3 kilometers. It is enclosed by two fences, which are separated by a wide isolation zone (30 metres or greater). Two Assessment Towers are located at opposite corners of the area.

The following three papers address each of the three key elements: (1) Intrusion Sensors, (2) Alarm Assessment, and (3) System Control and Display.

#### A -- PERIMETER INTRUSION SENSORS

M. J. Eaton  
Intrusion Detection Systems Division  
Sandia Laboratories, Albuquerque, N. M. 87115

#### ABSTRACT

To obtain an effective perimeter intrusion detection system requires careful sensor selection, procurement, and installation. The selection process involves a thorough understanding of the unique site features and how these features affect the performance of each type of sensor. It is necessary to develop procurement specifications to establish acceptable sensor performance limits. Careful explanation and inspection of critical installation dimensions is required during on-site construction. The implementation of these activities at a particular site is discussed.

#### I. INTRODUCTION

The primary role of perimeter intrusion detection sensors is to provide an early warning to the security force in the event of an unauthorized entry into a protected area. The performance of currently available perimeter sensors is critically influenced by the site environment, procurement specifications, and care in installation. This paper discusses the activities that were undertaken at a particular site to select, procure, and install perimeter intrusion sensors. The activities discussed typify those required at any site.

#### II. SENSOR SELECTION

The selection of sensor types must be based on a determination of the environment in which the sensors must operate and a knowledge of how that environment will influence sensor performance. Since the available knowledge correlating sensor performance to environment is very limited, on-site evaluation is required prior to final selection. Also, no single sensor presently available can successfully detect all intruder profiles (walking, running, crawling, etc.) without generating excessive nuisance alarms. A combination of two or more sensors, chosen to complement one another, can often result in performance that keeps this nuisance alarm rate (NAR) at an acceptable level without compromising the probability of detection (Pd).

The sensor selection process at this site included a Site Survey, Candidate Sensor Identification, and Experimental Installation phase. Each of these is discussed below.

#### A. Site Survey

The site survey must identify all the site features that will influence sensor performance. These include topography, soil composition, climate, animal population, road locations, isolation zone size, drainage, electromagnetic emitters (both ground and air-borne), and underground utilities (water, power lines, telephone lines, etc.).

The following tabulation identifies some of the salient features that are characteristic of this site.

<u>Favorable</u>	<u>Unfavorable</u>
(1) Relatively flat	(1) Consistent high winds
(2) Clay loam soil without rock	(2) Many small animals
(3) Limited snowfall	(3) In line with runway of major airport
(4) Wide isolation zones	(4) Railroad penetrations into site
(5) Symmetrical site boundaries	(5) Lightning storms

Plant Engineering "as built" drawings are typically neither accurate nor complete enough to depend on for site definition. Location discrepancies of over 3 metres in fence line position and unrecorded signal lines were uncovered as part of the survey. The candidate sensor bed was searched with pipe and cable locators to find unrecorded signal lines which could adversely affect buried line sensor performance.

#### B. Candidate Sensor Identification

Familiarity with the capabilities and limitations of available sensor types is required to identify candidate sensors. ERDA<sup>1</sup> and the DOD<sup>2</sup> have both issued publications that provide this information.

Two sensor-lines (primary and secondary) were adopted for this site. The primary sensor line, located within the isolation zone, assumes the major detection role. A secondary system, located at the inner fence boundary, will detect those rapidly moving targets attempting to outrun the data processing and assessment delays inherent in the system.

For the primary sensor line it was necessary to detect a broad spectrum of intruder profiles (running, crawling, rolling,

etc.) and to maintain a low nuisance alarm rate. No known single sensor can do this. The cohesive rockless soil and flat topography identified in the site survey neither excluded nor favored any particular family of sensors (buried, free-standing) when considering ease of installation. A buried cable and microwave combination was selected as the candidate primary sensor line because of the complementary detection ability of its components and their different nuisance alarm susceptibility. As an example, the most difficult detection profile for a microwave system is a slow rolling or crawling target which the buried cable detects easily. The buried cable is susceptible to nuisance alarms in high winds, whereas, the microwave is not.

Previous evaluation programs sponsored by both ERDA and the DOD indicated that the buried cable with the best known and most stable operating characteristics at selection time was the Air Force developed AM/GSS-26A (MAID/MILES) sensor. This is a multiphenomena pressure and magnetic sensor. The microwave sensor selected provided the best probability of detection over the 100 metre sector lengths of the MAID/MILES.

The secondary sensor line augments the detection capability of the primary system and functions as an assessment aid for rapidly moving targets. Time is required to process the data from a combination sensor system. This together with the limited width of the CCTV observation footprint, shortens the available assessment time. Locating a fence within the CCTV footprint helps to gain a few added assessment seconds. Locating the secondary sensor line at the inner fence boundary eliminates any potential assessment acquisition problems for rapidly moving targets. The details of how this is accomplished will be covered in the System Control and Display paper.

A fence mounted Electric-Field Fence (EFF) and the Air Force developed Fence Disturbance Sensor (FDS) were selected for the secondary system. The EFF was selected because it was the only known fence-associated system that also provided some proximity detection. The FDS was selected because it provided an economical way of augmenting the EFF to ensure detection of certain intrusion profiles. The FDS is a simple mercury jiggle switch. It is one of the least sophisticated of the available fence sensors and also one of the least expensive. It is not as good at detecting fence cutting intruders as some other fence sensors are. It does do a good job of detecting rapid climbers, and is assigned this role in the detection system. Both of these systems are susceptible to wind-induced nuisance alarms; however, in this application the target of concern is moving rapidly and therefore more latitude is possible with the sensitivity adjustment.

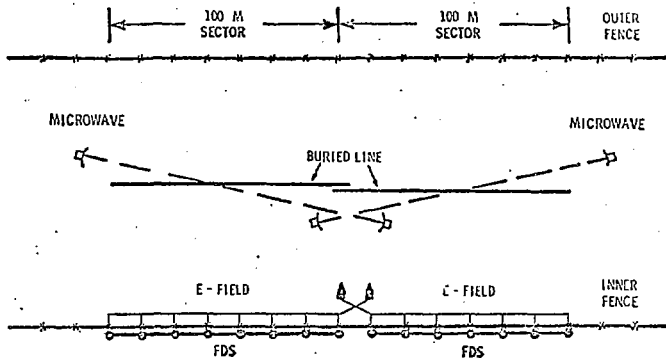

Fig. 1 Sensor Location Diagram

To take advantage of a multisensor system, an alarm interpretation hierarchy must be developed to assign priorities to different alarms and alarm sequences. Modifying these priorities with existing weather data is also useful. Both of these factors have been included in this system and will be discussed in detail in the System Control and Display paper. The system goal is to establish a Pd of greater than 0.95 while maintaining a NAR of no more than one in several days for high priority alarms.

### C. Experimental Installation

All of the candidate sensors were set up in an on-site experimental installation to determine how they react to unique site features and to obtain specific installation dimensions. Listed below are the major tests performed at the reference site. The findings are indicative of the type of information to be obtained; however, specific tests and results could be very different at another site.

1. Three different MAID/MILES cables were buried at 30, 45, and 60 cm to determine the sensitivity and nuisance alarm rates (NAR). In this particular soil, 2.5 cm of depth was approximately equal to one dB of attenuation. The 30 cm deep cable would constantly alarm at wind speeds in excess of 30 km/h and would also alarm when rabbits crossed the cable. Both the 45

and 60 cm cables had satisfactory wind and rabbit NAR performance; however, the 60 cm cable would miss some of the more careful intrusion attempts. Forty-five cm was selected as the final burial depth.

Experience at other sites indicated that railroad penetrations could adversely affect both the probability of detection and NAR of the MAID/MILES sensor. An experimental cable was buried under the railroad track to test this. With careful preparation it was possible to achieve adequate sensitivity and NAR performance at the railroad penetration.

2. Two overlapping microwave sectors were installed. It was determined that some of the mounting hardware was inadequate and that the recommended alignment procedure was inappropriate for the high wind conditions experienced at this site. When the microwave units were set to successfully detect a crawling intruder, they would also detect jackrabbits. This required excluding rabbits from the isolation zone. After consultation with various agencies such as the Game and Fish Department and Department of Agriculture, it was determined that the most effective way to keep rabbits out was to install a buried two-foot extension to the existing chain-link fence, sloped away from the isolation zone.

Some brands of microwave units have experienced problems with airport associated radars. Testing showed that no problems of this nature were experienced with the selected units.

3. Two sectors of the EFF were installed. It was determined that the 45 cm standoff hardware supplied by the manufacturer permitted high NAR resulting from fence vibrations for wind speeds in excess of 40 km/h. Increasing the standoff distance to 60 cm and weaving a cable through the chain-link fabric to stiffen the fence panels significantly decreased the wind induced nuisance alarms.

4. Two FDS sectors were installed. A wind filter was also tested with this sensor. The wind filter requires a number of closures within a set time frame to cause an alarm. The wind induced nuisance alarms became a problem around 40 km/h when the trip level was set at the recommended three turn sensitivity and the wind filter was not used. When another one-half turn was added to the trip level and the wind filter was used, wind velocities of 50 km/h did not produce nuisance alarm problems and the ability to detect a rapidly climbing intruder was not sacrificed. Satisfactory performance at much higher wind velocities is expected; however, 50 km/h was the highest wind velocity recorded during the experimental evaluation.

A problem occurred with a new section of chain-link fence installed to complete the isolation zone. This new fence utilized a Heavy "C" Form line post instead of the Senior "H" post used on the existing fence. FDS's mounted on the new fence produced nuisance alarms at very low wind speeds (15 km/h). Tests indicated that the "C" posts would flex twice as much as the "H" posts with the same force applied. A two metre section of the top bar material had to be welded to the "C" post to obtain a stiffness equivalent to the "H" post.

### III. HARDWARE PROCUREMENT

The documentation and characterization of commercially available hardware is typically very limited. The suppliers contacted expressed the opinion that today's market is dominated by a strict low bid philosophy and that an upgraded product would not be competitive. Most orders are handled on a model number basis with the model number loosely defined in a marketing brochure.

To obtain hardware with reliable and predictable operating characteristics, procurement specifications were developed that required utilization of wide temperature range components and thorough acceptance testing. Included in this procurement were detailed maintenance and trouble-shooting manuals to support the hardware after installation. No attempt was made to improve the basic hardware designs because of the one-year program schedule.

### IV. INSTALLATION

The cost, difficulty, and importance of on-site construction required to support the sensor system can be easily underestimated. At this site, construction costs were approximately one-quarter of the overall budget. Approximately 20 km of trenches containing 100 km of cable were required to support a 3 km detection and assessment system. Figure 2 is a photograph of the construction activity.

The following are examples of some of the more critical construction details:

A. The MILES cable must be buried 45 cm below grade. Variations of more than 5 cm will influence NAR and detection performance. An 8 cm layer of washed sand is placed below and above the MILES cable to permit accurate burial depth and prevent damage.

B. The surface between microwave transmitter and receiver pairs (one sector of 100 m) must have a constant slope within  $\pm 8$  cm if a crawling target is to be detected. This surface must be over the MILES cable.

C. Drainage must be adequate and the surface stabilized so that once the sensor bed is established the above tolerance specifications are not affected by erosion.

D. Adjacent microwave sectors must overlap in a crossing pattern (see Fig. 1) to protect the insensitive zone directly in front of the units and to prevent mutual interference. This requires careful location of the mounting posts.

E. Nearby power lines and signal lines will adversely affect NAID/MILES performance.

F. Signal, power, and data cables must be separated to prevent mutual interference.

The most difficult aspect of installation is to control the tendency for contractor improvisation in unfamiliar construction areas. Contractor personnel with no experience in projects of this kind tend to have a poor understanding of the problems that can be caused by nicked or crushed signal lines, proximity of power and signal lines, or small location variations in a wide open isolation zone. Nearly continuous explanation and inspection of critical installation dimensions by cognizant personnel is required. This can present a problem because of the division of responsibility between design and inspection functions at most facilities. The best system design and hardware procurement possible will be wasted if the on-site construction and installation is not done properly.

#### V. CONCLUSION

To obtain an effective perimeter intrusion detection system requires a thorough understanding of the site environment and the effects of that environment on candidate sensors; development of procurement specifications to stabilize and document sensor performance; and careful installation inspection during the on-site construction phase. Unalterable conditions such as weather extremes, soil conditions, or frequency interference must be accounted for in sensor selection. Alterable conditions such as terrain roughness, fence stiffness, or fence location must be controlled during the installation phase. Perimeter intrusion sensors can provide a significant contribution to physical security if they are properly selected, procured, and installed.

#### References

1. Intrusion Detection Systems Handbook, Sandia Laboratories, (SAND76-0554) November 1976.
2. Fite, Robert A., Commercial Perimeter Sensor Evaluation, U. S. Army MERADCOM, February 1977.



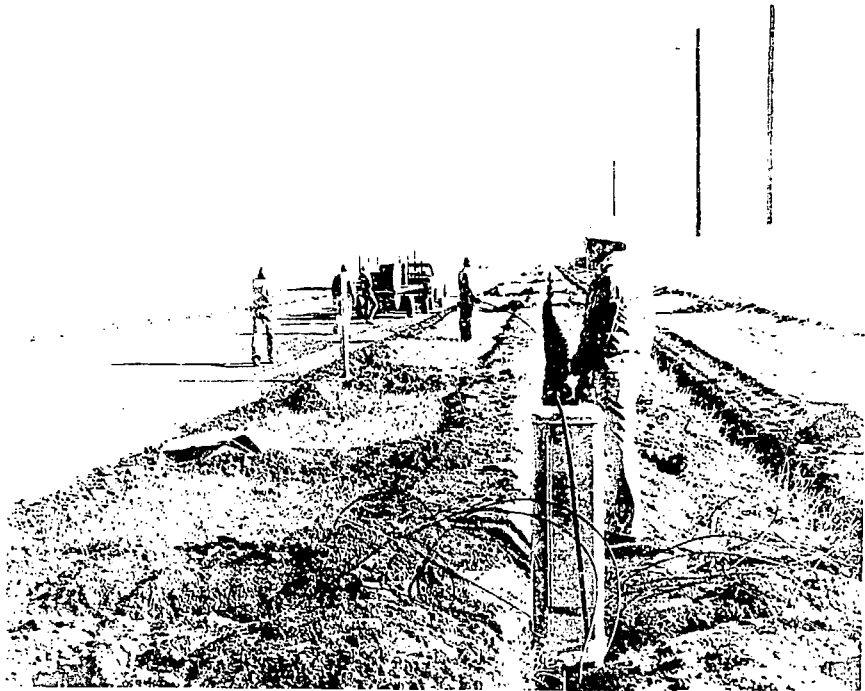

Fig. 2 Site Construction Activity

## B - ALARM ASSESSMENT

Douglas E. McGovern  
Security Systems Integration  
Sandia Laboratories, Albuquerque, N.M. 87115

### ABSTRACT

Alarms must be assessed to determine the cause of the alarm and what response action is required. Some information on cause can be derived through proper application and processing of sensor inputs. The final determination of cause and the initiation of required response is derived, however, from observation of the alarm area by a security system operator. This can be done directly (manned guard towers on the perimeter) or remotely (closed circuit television), and real-time (coincident with the alarm) or delayed (post event analysis). Methods to perform assessment are discussed, and the application of these methods in an installed site are detailed.

### I. INTRODUCTION

Assessment is the final determination of the cause of an alarm by security system personnel. The initial input is normally a signal from an intrusion sensor. This can provide some assessment information through a combination of sensor inputs and processing which incorporates signal analysis and weather information. The ultimate assessment, however, is derived from observation of the alarm site by security personnel.

### II. TYPES OF OBSERVATION

Observation can be accomplished in any of four ways, real-time or delayed and live or remote. Real-time live assessment is performed from manned observation towers which provide direct visual access to the entire perimeter. Real-time remote assessment uses closed circuit television (CCTV) to relay a picture of the alarm site to security personnel stationed in a central control room. Delayed live assessment depends on the dispatch of roving patrols to the alarm site. Delayed remote assessment is through recorded video information.

At the reference site, the assessment and detection functions are divided and all four types of assessment are provided. Two observation towers provide direct visual access to the entire perimeter. Sensors provide an input to roving patrols for delayed

live assessment. Closed circuit television cameras installed at intervals around the perimeter provide both real-time remote assessment and, through use of video disc and tape recorders, delayed remote assessment.

### III. OPERATION

The primary operational modes use the observation towers and CCTV for real-time assessment. This is a highly redundant system which insures rapid, accurate assessment and timely response to all alarms.

Inclement weather may reduce visibility to the point that direct visual access to the full perimeter by security personnel in the observation towers is impossible. Each camera of the CCTV system, however, looks at a sensor sector a maximum of 350 meters from the camera. Thus, while the tower operator may not be able to see the entire length of one side of the perimeter (approximately 1,000 meters), the CCTV cameras will provide a usable picture of all sensor sectors.

If visibility is reduced to less than 350 meters, the CCTV system is inoperative. Assessment is then performed by roving patrols dispatched to the alarm site.

Multiple alarms may create an overload situation for real-time assessment since the observation tower personnel and CCTV system operators cannot assess a large number of alarms simultaneously. This is handled by recording video signals on a video disc to preserve the view of the alarm site at the time of the alarm. This video "snapshot" can then be effectively assessed even after the cause of the alarm has gone from the scene.

The installed system thus uses a combination of manned observation towers, roving patrols and CCTV with recording to provide assessment in all weather and under all alarm conditions. The two components of the system are the security personnel and the CCTV network. The functions of the security personnel follow standard practices and will not be discussed further. The remainder of this paper addresses the design and installation details of the closed circuit television system.

### IV. BASIC CCTV SYSTEM

Thirty-three cameras are installed around the perimeter with each camera providing visual access to the area spanned by one set of sensors. Cameras are hardwired to an equipment building located at the site. Video signals are then checked for presence or absence of a picture. Signals to be sent to the Security Command Center, located approximately 1.6 km from the site, are switched into a multiplexing network. These signals are transmitted over a single cable and demultiplexed at the Security

Command Center for display or recording. Master sync is generated at the equipment building on site and transmitted to the camera.

Figure 1 is a block diagram of the system identifying each of the major elements. These will be discussed below.

#### Cameras and Lighting

The initial choice in designing a CCTV system is the determination of the resolution required. At this site, it is necessary to detect small animals and to identify a man. Reference to literature<sup>1,2,3</sup> and experimentation at Sandia established a reasonable maximum horizontal field of view (width of scene viewed on the monitor) of 30 meters for detection of small animals.

The second choice in design is the minimum width of area to be viewed. At this site, it is necessary to provide video coverage of both the primary and secondary sensor lines. It is also desirable to observe some area on either side of the sensor to allow maximum time for assessment of intruders or animals going in or out. Thus, the required area of video coverage is a band around the perimeter. Limits of coverage extend from about one meter inside the secondary sensor line (inner perimeter fence) to the outer edge of the clear zone around the primary sensor line. With cameras aligned to look along the fence, the minimum width of the field is then about 21 meters.

The final choice is the depth of area to be viewed. The depth of field combined with the minimum required horizontal field of view and the maximum allowed horizontal field of view establishes the focal length lens to be used. Since only a limited number of long focal length lenses are available, the speed of the lens (f number) is indirectly established and thus the lighting required for night vision. This final choice requires careful analysis of trade-offs between lighting, operational consideration, price, etc. For example, if two cameras cover different parts of the same alarm sector, the equipment for display and recording must be replicated. If a slow lens is used (say an f 5.6 lens), it is necessary either to light the area from both sides to achieve adequate light or to procure very low light level cameras with their attendant cost and complexity.

A compromise was reached at this site which allowed coverage of each sensor sector by a single camera equipped with a 135mm lens. Silicon diode tubes (.05 lumens/m<sup>2</sup> minimum face plate illumination) and a fast lens (f 1.8) are used to provide adequate operation from daylight to less than 10 lumens/m<sup>2</sup>.

Lighting is provided by 400 watt high pressure sodium (HPS) lamps mounted two to a pole as a direct replacement for the original lighting. This lighting provides a minimum (end of life)

illumination of 10 lumens/m<sup>2</sup> in a horizontal plane from the fence to the edge of the clear zone (21 meters). The light to dark ratio is better than six to one. The latter was found to be highly critical for good night video pictures.

Figure 2 illustrates the details of camera installation. An environmental housing, equipped with a defroster, cooling fan, and windshield washer and wiper, is used to insure that vision is not impaired from dirt, water, or snow accumulation on the lens and that camera internal temperatures are held in a reasonable range.

The camera is positioned directly above the inner perimeter fence looking along the fence.

The mount and pole, sufficient to support the camera in winds up to one hundred miles an hour, must be carefully sized to avoid interference with sensors. Wind induced vibrations will create seismic waves emanating from the base of the pole. If the poles are too close to the buried line sensors, the sensors may alarm from this seismic signal creating a source of nuisance alarms. The standard guideline is one pole length between sensor and pole which tends to limit the mounting height for assessment cameras.

Figure 3 shows a photograph of the daytime view from a camera at Sandia in an installation similar to that discussed above. In this and in Figure 4, the night time view, the predominant surface is loose graded soil. At the lower right is a section of asphalt paving leading onto a hard packed dirt road. At the upper right is normal desert vegetation.

Note the relative size of the man and the telephone pole and the effect of ground surface on visibility. Inspection of video scenes like these indicated the need to remove all possible objects from the field of view and to carefully stabilize the ground surface. The latter was initially required for sensor installation, but the need for it in assessment is equally clear.

#### Transmission and Switching

The maximum cable length from a camera to the equipment enclosure is 1.5 km. The video signal is sufficiently attenuated in this length of rigid coax to require regeneration of the signal. This is provided by video equalizers installed in the equipment building.

The 33 camera lines are input to a 40 x 10 remote controlled video switcher. This switcher isolates those cameras required for display or recording in the Security Command Center (SCC) and is driven by the SCC computer installed there. Seven

of the available outputs are used to supply separate video signals to four different monitors, two video discs and a video tape recorder. The other three outputs are used for test purposes.

The seven display and recording lines are modulated and combined on a single rigid coax for transmission to the SCC 1.6 km distance. The single cable system, similar to cable television usage, allows easy system expansion in display location and number of channels without the need for a large number of buried cables or extensive video signal conditioning.

After demodulation at the SCC the video signals are input to a 10 x 10 video switcher. This switcher, also under the control of the computer, routes signals either to monitor displays or to the input of one of two video disc recorders or a video tape recorder. The outputs of the disc recorders can be rerouted through the switcher to the monitor displays.

#### Recording and Display

Recording of video signals is done for two reasons. First, a temporary recording is made of the initial few seconds after a sensor has alarmed. This provides a "snapshot" of the alarm scene which can be looked at anytime after the alarm. Second, a permanent recording is made for retention of any significant event.

The temporary recordings are made on two video disc recorders. These provide almost instantaneous recording of up to 500 frames of video data. Any frame is readily accessible for replay or rerecording, and the alarm scenes can be shown in any order. The video discs are controlled by the alarm processing computer in the SCC.

Permanent recording is on video tape. This is not as accessible nor as versatile as disc recording but can record several hours of continuous video data in an easily stored and replayed fashion. Included in any tape recording are the pertinent scenes recorded by the video discs at the time of the alarm.

Display of live or recorded scenes is on 23 cm dual rack mount monitors mounted at eye level for a seated security system operator.

#### Line Supervision

The video transmission lines are supervised by monitoring the quality of the video picture. Each of the 33 cameras is continuously monitored for loss of sync, low picture levels (all dark), or high picture levels (all white). This is performed prior to the initial switching in the equipment enclosure. The

results of the picture test are transmitted to the SCC over the same line as the video data. The format is such that the signal needs to be present to indicate a functioning system. Thus, loss of any cable will be indicated to the operator.

#### Master Sync

Video synchronizing signals are generated in the equipment enclosure for all cameras and the switcher. Appropriate delays are added to maintain exact timing for all signals.

Master sync is included to insure high quality switching and recording. It also allows expansion of the video system to include more sophisticated video processing, motion detection, etc. A side benefit of using master sync is that all cables to cameras are duplicated. If a video cable deteriorates or is damaged, that camera can run on internal sync and use the sync cable for video transmission.

#### Lightning

The reference site is in a high lightning probability area. It was therefore imperative that adequate lightning protection be provided. Protection of power and signal lines is a straightforward application of off-the-shelf gas tubes. These act to clamp voltage to 100 to 300 volts. This level of protection is not adequate, however, for video cables. Additionally, video will tolerate only very low parasitic capacitance on the line.

The solution at this site was a combination of a spark gap and sets of matched high current diodes. This hardware will clamp at approximately 8 volts and will conduct up to 450 amps with only 100 pf of capacitance added to the video line. The effect of this capacitance can be compensated for in the equalizers.

#### Miscellaneous Hardware

The above represents the major components of the assessment system. Many other pieces are necessary for proper system function such as environmental protection of cameras, noise suppression on video cables, provision of test and adjustment ports, data transmission for line supervision functions, etc. These represent a large commitment of design effort but will not be discussed further since they, like the problems encountered in installation, follow normal television system practice.

#### V. CONCLUSIONS

Three major conclusions can be drawn from the experience gained during design and installation of this assessment

system. The first is that assessment can represent a large fraction of the installation cost of a perimeter intrusion detection and assessment system. At the reference site over thirty percent of the combined purchase and construction budget was allotted to assessment.

Second, the assessment subsystem is closely tied to the sensor subsystem. Such things as video cable routing, camera pole location and height, and lens and lighting specification interact directly with sensor layout. Sensor spacing is dependent on the capabilities of the video system. For example, it would be quite possible to design a sensor system which required an excessive number of cameras to provide adequate assessment.

Third, although video design is relatively straight forward, the specification and installation of an effective assessment system are not simple.

#### References

1. Johnson, J. "Analytical Description of Night Vision Devices" Proceedings of the Seminar on Direct-Viewing Electro-optical Aids to Night Vision.
2. Steedman, W., and Backer, C. "Target Size and Visual Recognition", Human Factors, Vol. 2, Aug. 1960.
3. "Electro Optics Handbook", RCA Technical Series EOH-11, 1974.



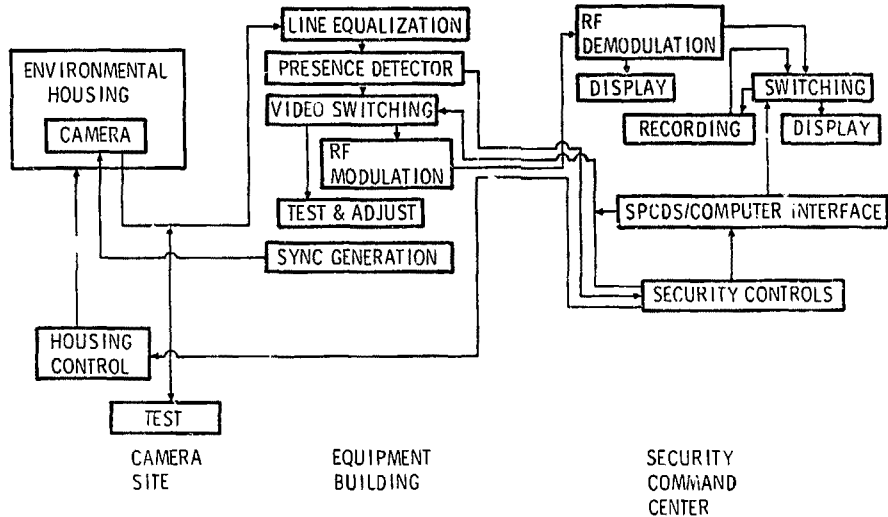

FIGURE 1

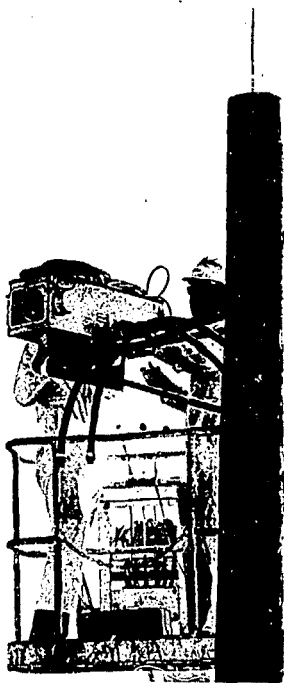

Fig. 2 Camera Installation

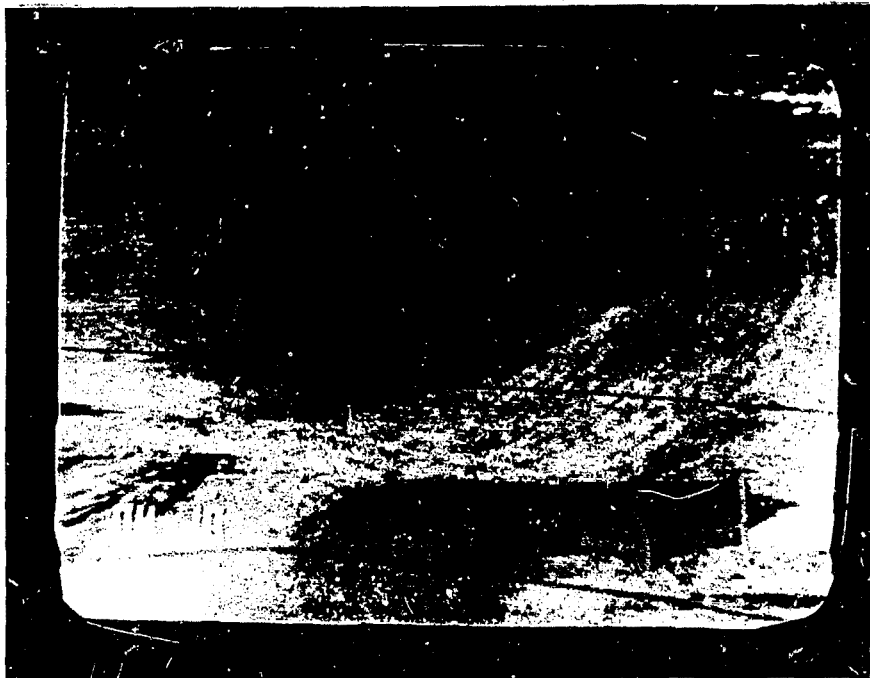

Fig. 3 CCTV Daytime View



Fig. 4 CCTV Night-Time View

## C - SYSTEM CONTROL AND DISPLAY

James Jacobs  
Security Systems Integration  
Sandia Laboratories, Albuquerque, N.M. 87115

### ABSTRACT

The system described was designed, developed, and installed on short time scales and primarily utilized off-the-shelf military and commercial hardware. The system was designed to provide security-in-depth and multiple security options with several stages of redundancy. Under normal operating conditions, the system is computer controlled with manual backup during abnormal conditions. Sensor alarm data are processed in conjunction with weather data to reduce nuisance alarms. A structured approach is used to order alarmed sectors for assessment. Alarm and video information is presented to security personnel in an interactive mode. Historical operational data are recorded for system evaluation.

### I. INTRODUCTION

The purpose of the program discussed is to provide a Perimeter Intrusion Detection and Assessment system for the facility described in the preface. This system will upgrade the existing security posture and will assist security personnel in thwarting any intrusion. The major areas of effort were perimeter intrusion sensors, alarm assessment, sensor data communications and display, and system integration. Sensors and assessment were presented in the previous two papers; the remaining areas will be discussed in this paper.

### II. SYSTEM CONSIDERATIONS

The short time scale of 12 months for this program would not permit involvement in medium or high-risk design and development activities, but restricted the hardware selection to proven, off-the-shelf commercial and military equipment. Hardware was developed or modified only if required to meet special system requirements or to interface the various system elements. The system concept was designed to provide security-in-depth, such that the failure or defeat of any single system element, either hardware or personnel, would not compromise the integrity of the total system. Security-in-depth was accomplished, in part, by using:

1. A redundant system configuration which would permit continuing system operation should a major component or subsystem fail;

2. Multiple intrusion detection sensors in each perimeter sector;
3. An alarm assessment technique which requires at least two individuals to assess sensor alarms;
4. Alternate hardened control centers, widely separated spatially, to reduce the vulnerability of the system to single point attack; and
5. A sensor control technique which prevents an individual from placing sensors in the access mode (inoperable) without other security personnel being aware of this operation.

The system was designed to be expandable to allow for reasonable future expansion.

### III. SYSTEM DESCRIPTION

A simplified block diagram of the system is shown in Figure 1. All of the functional blocks shown below the dashed line are contained within the security zone. The Security Command Center (SCC) is located approximately 1,600 meters from the security zone. During normal operating conditions, the SCC has primary control of the system with the guardhouse performing only a system monitoring function. The guardhouse is also configured to operate as a backup command center, and control will be transferred as required by the operational status of the remaining system elements. The perimeter sensor and CCTV data are transmitted by buried cable to the SCC via the equipment building which is the central data collection and distribution point for the system. All of the video distribution and sensor data multiplexing is performed within this building; a complete weather station is installed on the roof to provide the required environmental data. Sensor data are transmitted independently to both the guardhouse and the SCC. The assessment tower displays may be driven by either the SCC or the guardhouse equipment depending on the operational mode of the system. The SCC, guardhouse, and assessment towers communicate via telephone, radio, and dedicated intercom.

### IV. CONTROL AND DISPLAY

The system uses a Small Permanent Communication and Display Segment (SPCDS) and a Computer Control and Display System with several stages of redundancy. The SPCDS (AN/GSS-29(V)) equipment was developed by Sandia Laboratories for the Air Force Base and Installation Security Systems Program Office (BISPO) to be used in military security systems. The equipment was used in the present application to perform (1) sensor data multiplexing, (2) sensor data transmission and line supervision, and (3) geographical display of sensor alarms in both the primary and secondary command centers. Although the SPCDS equipment

provides all of the sensor data and line fault information to the computer, it operates totally independent of the computer and when coupled with the assessment towers or manually controlled CCTV, provides a totally independent and complete detection and assessment option in this system. The SPDCS control and display hardware is provided in both the SCC and guardhouse. The guardhouse equipment is shown in Figure II.

A computer was utilized in the control and display subsystem to provide the capability for (A) automated system control and display, (B) data processing, (C) changing control logic during development, and (D) expanding the system for future requirements.

For normal operating conditions, the computer performs the following functions in this system:

1. Process sensor and weather data;
2. Drive tower, security console, and hardcopy displays;
3. Control the video assessment subsystem;
4. Display data at potentially high rates to security personnel in a useful format and in an interactive mode; and
5. Provide historical operating data for system evaluation.

The computer control and display subsystem uses dual minicomputers configured as shown in Figure III. The computers, as shown, are connected through an interprocessor buss with one primary CPU capable of complete system control and the other providing automatic backup should the primary fail. The computers are programmed in Fortran V using a disc operating system. All peripherals are available to either CPU via the buss switch.

#### V. SENSOR DATA PROCESSING

External intrusion detection sensors available today are incapable of automatically discriminating between valid alarms caused by an actual intruder and nuisance alarms caused by small animals, flying debris, and environmental conditions. In addition to providing animal barriers to reduce nuisance alarms and CCTV to assess nuisance alarms, perimeter sensor data are processed in conjunction with weather data to further reduce the number of nuisance alarms. The measured weather data include:

Wind velocity

Wind direction

Moisture fall rate  
Humidity  
Barometric pressure  
Temperature  
Potential gradient

Estimates of the magnitude of wind gusts and rate of change of potential gradient are derived by the software from the measured weather data.

The alarm processing logic is table driven. Various programs run as independent tasks and communicate with each other to modify data contained in the tables. The table entries may be changed or updated by the operating software (based on implemented logic) or by the programmer to reflect changes in sensor performance. The software assigns a status (Enabled, Masked, or Inhibited) to each sensor depending on the existing weather conditions which could affect the validity of the alarm. The definition of sensor status conditions are:

- |           |   |
|-----------|---|
| Enabled   | - Valid alarm. The magnitude of the weather conditions are well within the acceptable range for the sensor.   |
| Masked    | - The magnitude of the weather conditions are within a range that the sensor might be affected. Therefore, the alarm data are weighted depending on the alarm conditions of other sensors in the same sector. |
| Inhibited | - Alarm is ignored. The magnitude of the weather conditions are beyond the acceptable range for the sensor.   |

Any of the nine sets of weather data can cause a mask or inhibit bit to be set for a given type of sensor. Since weather conditions are updated at one second intervals, the decision to mask or inhibit a sensor is made on a nearly continuous basis.

During periods when numerous sensors are alarming, a method was devised to determine the order in which alarms should be assessed. In the limit one would like to separate the alarms caused by intruders and only evaluate or assess these alarms. Although this goal is unattainable with present technology, a structured approach can be used to evaluate, in order, the alarms that are most likely to have been intruder caused. Based on the method used to deploy sensors at this facility, multiple alarms from different sensors in one sector have a higher chance of being caused by an intruder than single alarms in other sectors.



Therefore, a priority structure has been defined to determine the order in which alarmed sectors will be assessed. The priority (0, 1, 2, or 3) assigned to a sector depends on the status of the sensors (i.e., Enabled, Masked, Inhibited), and on the number and combination of sensors that are in alarm. Priority "0" means the alarm is ignored by the system. Priorities "3" through "1" are displayed with priority "1" being the most important. The assigned sector priorities may be updated during a short time period following the initial alarm in the sector such that a priority "3" may progress to a priority "1" depending on the alarms that occur during the specified time "window". Based on this priority structure, the system will automatically display first the alarmed sector of highest priority. If a number of equal priority sectors are in the queue, "a first in, first out logic" is used to determine the order in which the sectors are displayed.

A simple example of how priorities might be assigned to possible alarm conditions is illustrated in the following table:

Sensor Type				Priority	Remarks
1	2	3	4		
0	0	0	1	0	Any single masked sensor
0	1	0	0	3	Any single alarmed sensor
1	0	0	1	3	Any combination of two masked sensors in alarm
0	0	1	1	2	Any combination of two alarmed sensors
1	1	1	0	1	Any combination of three sensors in alarm

0 = Unalarmed sensor

1 = Alarmed sensor

☐ = Masked sensor

There are 2<sup>8</sup> possible combinations of sensor alarms and masking conditions that are assigned priorities, five of which have been illustrated. The alarm priority illustrated is only one of many that could be used.

Alarm "filtering" can be changed via the priorities entered in the alarm table, the environmental limits used to determine sensor status (Enabled, Masked, Inhibited), and the duration of the update time window. A flexible table structure has been implemented in the software to allow these parameters to be changed based on the results of operational data.

## VI. SCC CONSOLE

The SCC console is the primary interface with the security personnel. As shown in Figure IV, it has two duplicate operator positions. Each position has a keyboard, alpha-numeric display, and two computer controlled video monitors. The number 1 monitor, in each position, is for "live" or real-time video and the number 2 monitor for "playback" from video disc recorders. The two monitors, numbers 3 and 4, between the operating positions are normally manually controlled monitors which will display scenes from any sector when that sector is manually selected via the switches mounted above each of these two monitors. At the top of the console center section are the controls and indicator lights for the video presence detector and CCTV camera environmental housings. Radio, intercom and telephone communications equipment are contained in the bottom of this console section. The geographical display and the rack of equipment at the right of the console are the SPCDS equipment discussed previously.

When an alarm is received from a sector, the following events occur simultaneously:

1. SPCDS geographical displays are initiated with the appropriate sector alarm lights being energized.
2. Computer processes sensor and weather data to determine the validity of the alarm and establishes priority.
3. Audio tones are generated in the assessment towers and in the SCC to alert the security operators.
4. Tower display lights are energized indicating the sector in alarm.
5. Monitor "1" displays the alarmed sector scene.
6. The operator's console provides an alpha-numeric description of the sector, alarmed sensor and the total system status.
7. Weather and alarm data are output to the hardcopy and magnetic tape devices.

The SCC operator then assesses the cause of the alarm by viewing the video monitor and communicating with tower guards. The assessment is entered into the system via the CRT keyboard. If an intruder caused the alarm, the video scene is transferred to monitors 3 and 4, and a video tape recording of the scene is initiated for permanent retention.

If multiple sector alarms are received within a short period of time, monitor "1" will continue displaying real time or "live" information. If the live monitor is in the display mode and unavailable for incoming sector alarms, the computer will automatically switch the video from the new sector alarm to one of two video disc recorders. The disc recorder will record four seconds of video from the alarmed sector's camera and then, under computer control, playback this video on the "playback" monitor, number 2, at the operator's console. The interplay between the "live" and "playback" monitors, video disc recorders, and system computer will permit the operator to assess several sector alarms even if they occur in a short time interval.

The computer driven system also provides additional information which is used by the security personnel to implement their operational security procedures and to evaluate the status of the total system. The types of information available to the operator are:

1. Weather data, system status, and operator identification at operator shift changes;
2. System malfunction messages;
3. Sensor activity summaries;
4. Sensor access summaries;
5. Video test sequences; and
6. Operator training sequences.

## VII. CONCLUSION

An effective system can be designed using presently available commercial and military equipment. However, careful attention must be given to integrating this equipment into a viable system concept. In order to achieve the level of integration desired, a fair amount of interface hardware was required and had to be developed as the program progressed. Incorporating a minicomputer into the system control and display functions gives additional flexibility in achieving system design goals and provides capability to automate numerous functions that operational personnel would normally perform. The program described has demonstrated that with a vigorous effort this type of system can become operational on relatively short time scales.

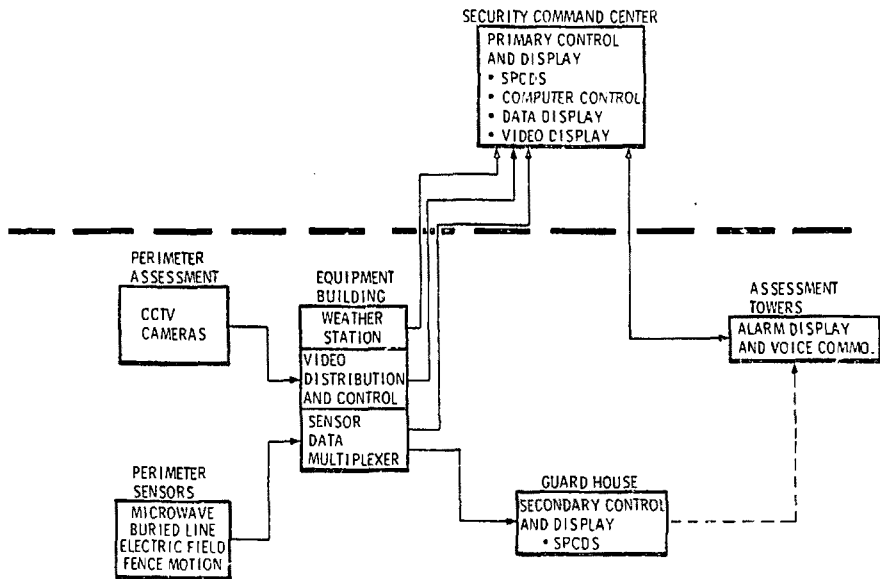

FIGURE 1

LINE FAULT INDICATORS

INTERCOM

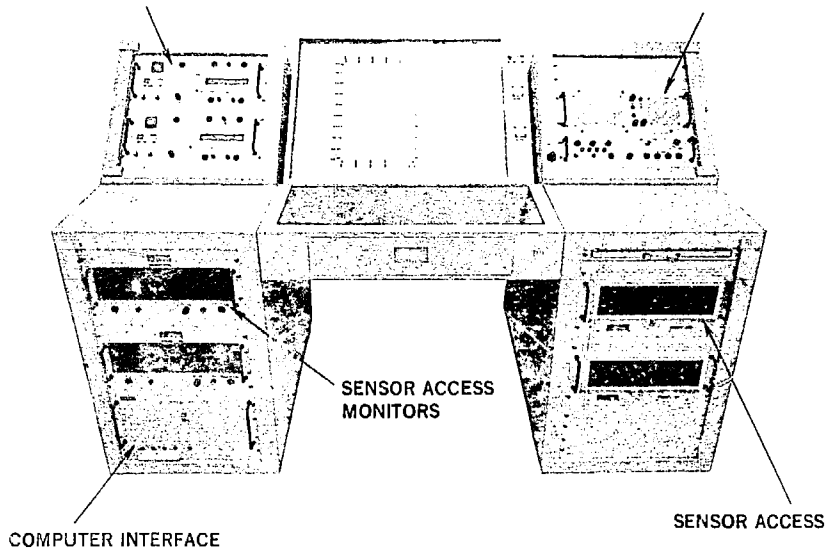

FIG. 2 GUARD HOUSE DISPLAY

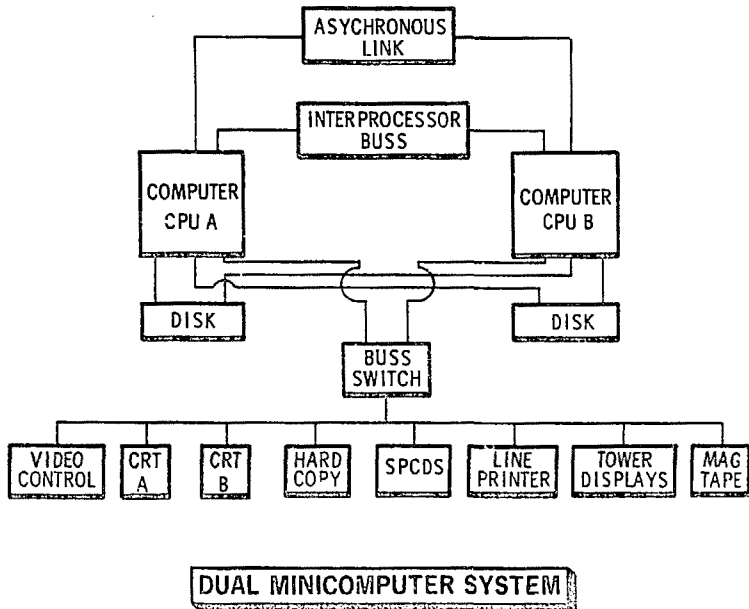
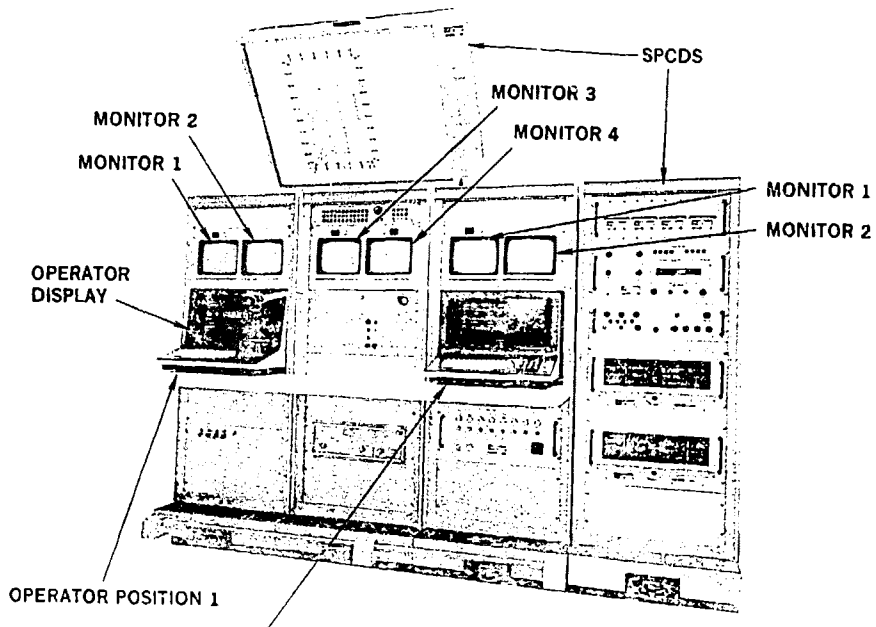

FIGURE 3



OPERATOR POSITION 2 FIG. 4 SCC CONSOLE