

#27  
5/29/80  
elm

UCID- 18588

**MASTER**

POLARIZER REFLECTIVITY VARIATIONS

R. G. Ozarski  
J. Prior

February 22, 1980

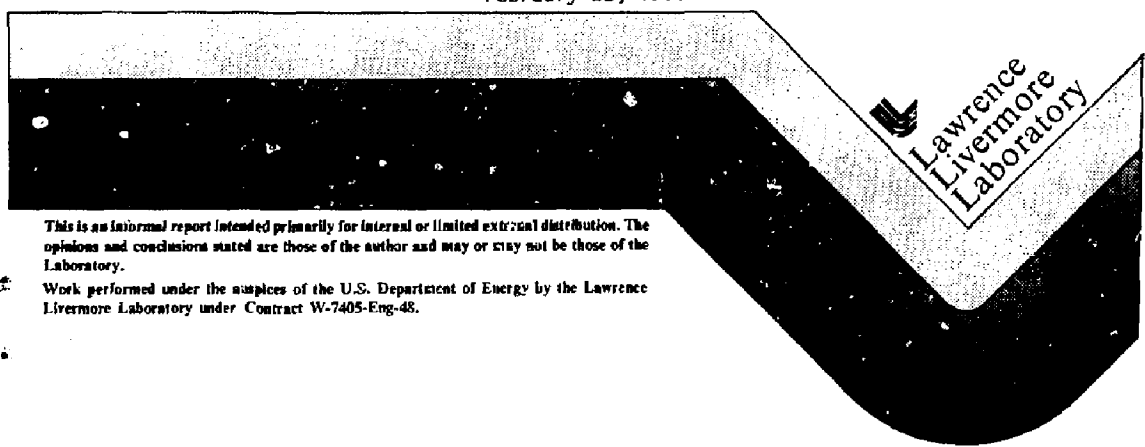

This is an informal report intended primarily for internal or limited external distribution. The opinions and conclusions stated are those of the author and may or may not be those of the Laboratory.

Work performed under the auspices of the U.S. Department of Energy by the Lawrence Livermore Laboratory under Contract W-7405-Eng-48.

## POLARIZER REFLECTIVITY VARIATIONS\*

R. G. Ozarski/J. Prior  
Lawrence Livermore National Laboratory  
P.O. Box 5508  
Livermore, CA 94550

### Introduction

On Shiva the beam energy along the chain is monitored using available reflections and/or transmission through beam steering, splitting, and polarizing optics without the intrusion of any additional glass for diagnostics. On the preamp table the diagnostic signal is obtained from the signal transmitted through turning mirrors. At the input of each chain the signal is obtained from the transmission through one of the mirrors used for the chain input alignment sensor (CHIP). At the chain output the transmission through the final turning mirror is used. These diagnostics have proved stable and reliable. However, one of the prime diagnostic locations is at the output of the beta rod. The energy at this location is measured by collecting small reflections from the last polarizer surface of the beta Pockels cell polarizer package (Fig. 1). Unfortunately, calibration of this diagnostic has varied randomly, seldom remaining stable for a week or more. The cause of this fluctuation has been investigated for the past year and it has been discovered that polarizer reflectivity varies with humidity. This report will deal with the possible causes that were investigated, the evidence that humidity is causing the variation, and the associated mechanism.

### The Experiment

The fluctuation in calibration at the Pockels cell was first thought to be related to the detector or associated electronics. This possibility was eliminated by comparing results at this location to others using the same electronics but not experiencing fluctuations in calibration. These types of comparisons lead to the conclusion that the observed calibration changes were caused by variations in the ratio of reflected to transmitted light at the polarizers.

---

\*Work performed under the auspices of the U.S. Department of Energy under contract W-7405-ENG-48, by the Lawrence Livermore National Laboratory.

To verify this a series of measurements were undertaken to determine whether this change was occurring and, if so, the cause. The following possibilities were investigated:

- . Variation in the polarization arriving at the polarizer due to Pockels cell voltage fluctuation.
- . Variation in the reflected to transmitted signal ratio due to Pockels cell or polarizer alignment changes.
- . Variation in transmitted to reflected signal ratio due to temperature or humidity changes.

#### Experimental Layout

The experimental set up used to investigate these possibilities is shown in Fig. 2. A chopped 3 mW 1.06  $\mu$ m beam was polarized by a glass prism and expanded by a microscope objective. A halfwave plate was used to rotate the polarization of the expanded beam to match the p component direction of a Shiva polarizer Pockels cell package. The signal transmitted through the polarizer Pockels cell assembly and the signal reflected by the last polarizer were focused into synchronous detectors and ratioed.

$$R/T \text{ Ratio} = \frac{\text{Reflected Signal}}{\text{Transmitted Signal}}$$

#### Voltage Variation

From previous measurements it was known that Shiva Pockels cell voltage varied during the pulse. Although the voltage variations were of insufficient magnitude to cause the observed calibration fluctuations, the sensitivity of calibration to these changes was tested. The voltage

to the Pockels cell was varied from zero to its halfwave voltage while monitoring the R/T ratio. It was found that the R/T ratio varied by less than 1% over the full operating range of the Pockels cell, indicating that voltage fluctuations are not causing the calibration fluctuations.

#### Alignment Fluctuations

In Shiva the extinction ratio of the Pockels cell polarizer package is adjusted by tuning the Pockels cell to obtain a contrast of 1000 or more. In service the extinction ratio gradually degrades to approximately 200, which is thought to be caused by gradual misalignment. To test whether the changing extinction ratio was affecting the R/T ratio and thereby the calibration, the Pockels cell was optimized and then misaligned over the same range as experienced during Shiva operation. No change in the R/T ratio was found for this kind of misalignment, eliminating it from consideration as a possible cause of calibration instability.

#### Temperature and Humidity

Temperature in the laser bay was found to vary by  $\pm 1^{\circ}\text{F}$ . However, the relative humidity exhibited large fluctuations. These fluctuations ranged from slow changes over a period of a week to rapid changes lasting hours. This is illustrated in Fig. 3, which shows plots of humidity in the laser bay for the weeks of December 14, 1978, and November 19, 1978. In the first case the relative humidity steadily increased from approximately 10% to 40%. During the week of November 19, 1978, the humidity decreased rapidly from 55% to 18% in a few hours after several days of very little change. This kind of humidity change strongly suggested itself as a possible driving function for the calibration change.

Using the experimental set up, the R/T ratio was monitored and compared to the ambient humidity fluctuations. A strong correlation between changes in the R/T ratio and changes in the humidity was

observed, with the R/T ratio varying inversely to the humidity. The ratio was also found to be stable during a two day period when the humidity was stable (Fig. 4). It was further observed that fluctuations in the ratio were greater with humidity variations at low humidity than at high humidity. An experiment was conducted to verify that humidity changes were causing this variation. Trays of desiccant were placed in the control volume during a period of high ambient humidity; this rapidly lowered the humidity but did not change the temperature. After the humidity stopped decreasing the desiccant and the top of the chamber were removed, allowing the humidity to rise rapidly to the ambient level. The result, shown in Fig. 5, clearly indicates that the ratio inversely tracks the humidity. The R/T ratio changed by approximately 60% for a 40% change in relative humidity in the chamber at constant temperature. This closely matched the fluctuations observed in the laser bay and the calibration changes that have occurred. It is significant to note that the R/T ratio tracked the humidity change virtually instantaneously within the time response for the hydrometer and the ratio detector.

#### The Mechanism

From the results obtained two hypothesis were formed. Since the change occurred very rapidly it was postulated that a surface effect was responsible. The first possibility was that a layer of water was being deposited on the coating as the humidity increased. The second possibility was that a change in the outer coating index was occurring due to water absorption. To test these hypothesis computer studies were performed by OCLI. Calculations were made assuming 2000A and 5000A layers of water deposited on the polarizer. Cases were also run in which the index of the last SiO<sub>2</sub> layer was varied.

The addition of a 2000A layer of water decreased the p component reflectivity from a nominal 2% to 1.3%, representing approximately a 46% change in the R/T ratio. A 5000A layer of water further reduced the p component reflected to .8% (approximately a 60% change). These calculated changes are in close agreement with those observed experimentally in both magnitude and direction. Changing the index of refraction of the outer SiO<sub>2</sub> layer had a negligible effect on reflection and transmission.

#### Plans for Shiva

To provide the Shiva laser with a stable diagnostic a beamsplitter design was tested for humidity sensitivity. A prototype installed on Shiva has proven to be stable as shown in Fig. 6. In this figure the fluctuations in the R/T ratio are plotted for one hundred twelve rod shots between August 23, 1979 and October 10, 1979. The deviation was less than 3% for 101 of 112 shots. The maximum deviation recorded occurred in 3 shots which exhibited 10% deviation; since these shots took place on the same day and the direction of deviation is consistent with *reduced energy incident on the calorimeter, misalignment of the calorimeter* is suspected. During this same period the energy fluctuation as measured from polarizer reflection shows large deviations.

This diagnostic station is also intended to serve as a near field photo station, and the prototype 1% splitter has given good near field photos. These diagnostics will be installed on all of Shiva's arms.

#### Conclusion

The experimental and theoretical results strongly support the contention that humidity is affecting the reflectivity of the polarizer, *thus causing the instability at the beta polarizer Pockels cell energy sensor*. Moreover, the effect is caused by deposition of water on the coating surface, and the magnitude of the reflectivity fluctuations

decreases with increasing humidity. Additionally, the fluctuation of humidity in the laser bay is sufficient to cause the behavior observed.

Solutions allowing use of the polarizer reflections to diagnose the beam without additional beamsplitters are being pursued. The possibility of altering the polarizer design to reduce its sensitivity to water deposition or make the outer layer hydrophobic is being examined. However, this is not a promising route since the yield for polarizers of current design is poor, and additional design constraints are likely to further reduce the yield. Another approach is use of a dry nitrogen flush or a heat source to keep moisture off the polarizers. In addition, alternatives such as pellicles for extracting energy for diagnostics are also being explored.

# PHOTODIODE POCKELS CELL ENERGY SENSOR

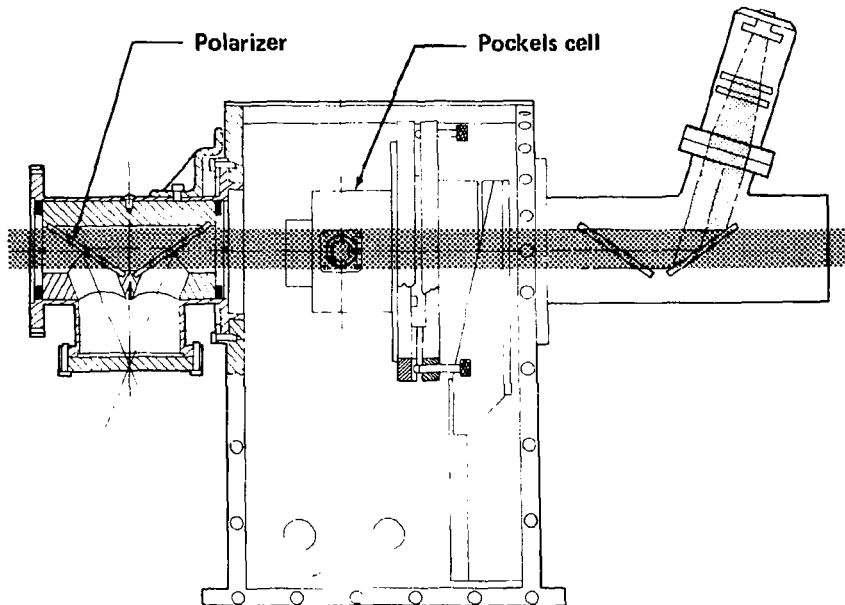
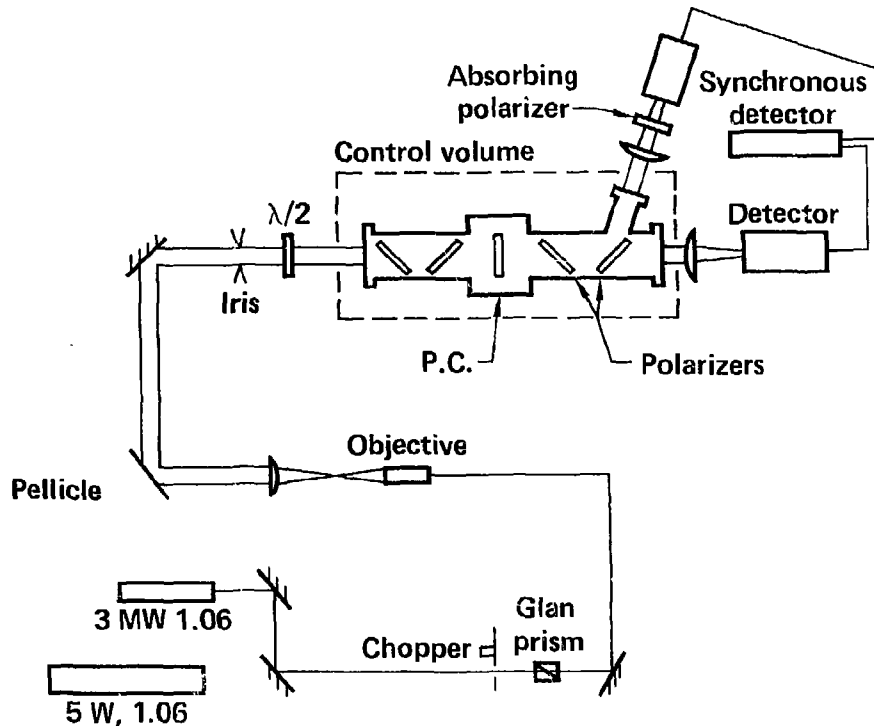

Fig. 1 - Photodiode Energy Sensor: A small fraction ( $\sim 1\%$ ) of the p polarization is reflected from the last polarizer in the Pockels cell polarizer assembly and collected by a photodiode. The integrated signal from the diode is calibrated to give the beam energy at this location.

02-05-0178-0215





02-01-1279-5176 Fig. 2 - Experimental Layout: A chopped cw 1.06 μm beam is expanded, polarized and passed through the Pockels cell polarizer assembly, which is in a chamber maintained at a controlled temperature and humidity. The reflected and transmitted beams are collected, synchronously detected, and ratioed.

# LASER BAY HUMIDITY

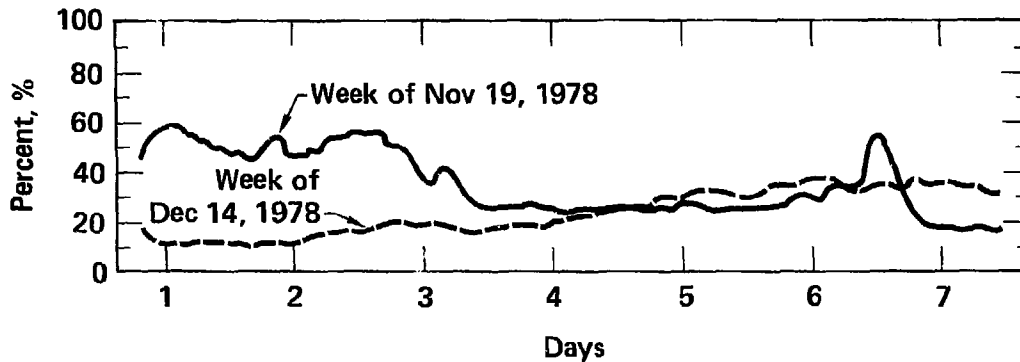

95-00-1279-5178 Fig. 3 - Humidity Fluctuation: The humidity in the laser bay experiences large fluctuations as shown.

# RATIO DURING STABLE RELATIVE HUMIDITY PERIOD

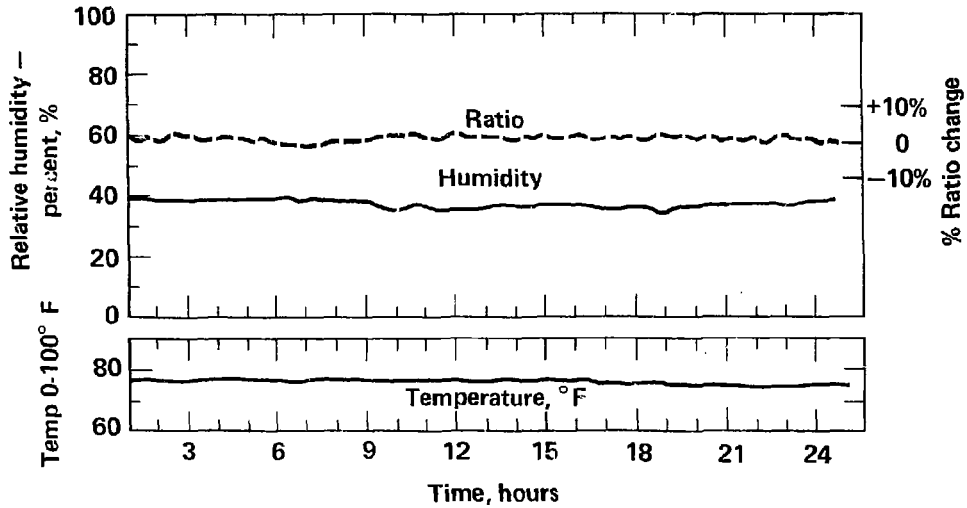

95-00-1279-5179 Fig. 4 - Ratio, Humidity and Temperature: The ratio of reflected to transmitted signal remains stable during periods of stable humidity as shown here.

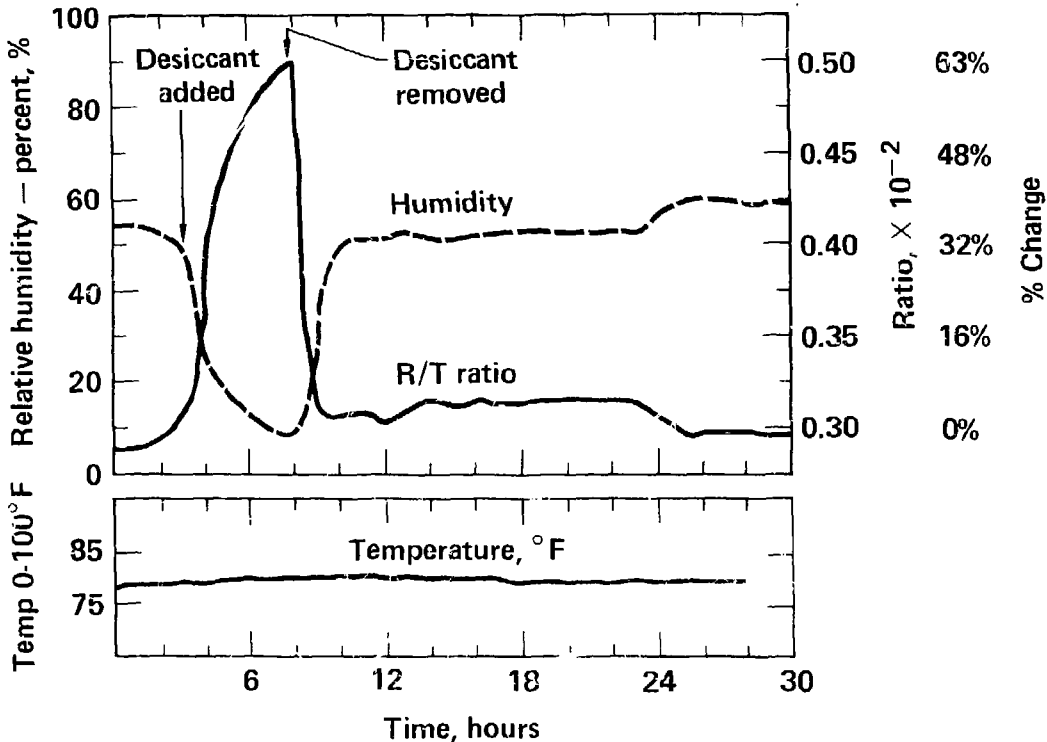

95-00-1279-5177 Fig. 5 - Varying Humidity Produces Varying R/T Ratio: When the humidity in the control volume was varied (at constant temperature), the reflected to transmitted signal ratio experienced large changes in response to the humidity changes.

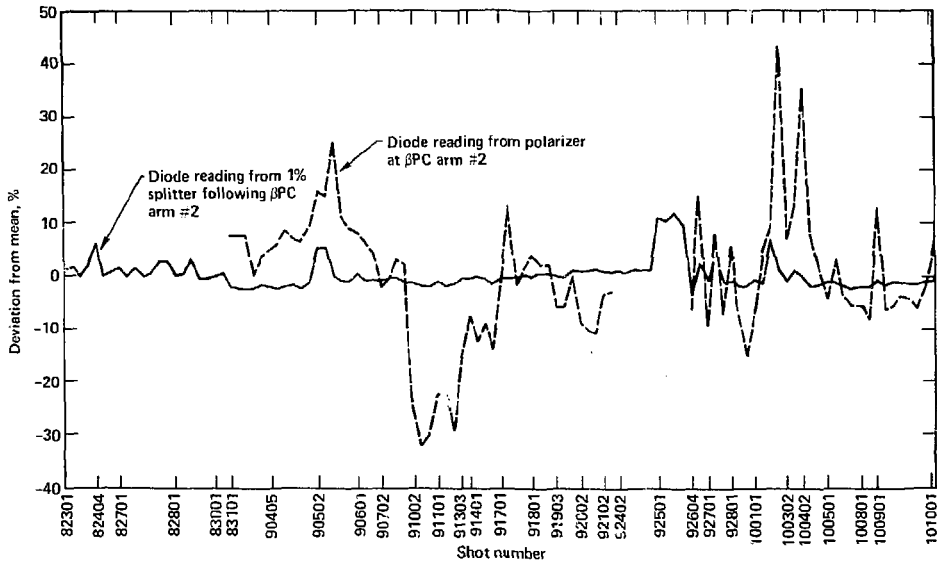

**02-90-1079-4544** Fig. 6 - Prototype Beamsplitter Stability: Calibration of a prototype beamsplitter installed at the Pockels cell polarizer assembly output has remained stable. The detector on the polarizer underwent large fluctuations during the same test period.