

MASTER

I. INTRODUCTION

TWO PHOTON PRODUCTION OF CHARM STATES  
A CHARMONIUM CALCULATION \*

Roberto Suaya †  
Stanford Linear Accelerator Center  
Stanford University, Stanford, California 94305

The work that I am reporting here has been done in collaboration with Carl E. Carlson. The charmonium model as discussed by Appelquist and Politzer<sup>1</sup> and more particularly Eichten et al.,<sup>2,3</sup> has been used in order to calculate the production of charmed particles in two-photon processes in  $e^+e^-$  colliding rings. The charmonium model provides us with a nonrelativistic description of heavy quark bound states.

Among the more salient predictions of the model in its "naive" form (defined as that in which the physical sector is purely described in terms of  $c\bar{c}$  bound states) are:

- A.  $\psi'(3685)$  in a radial excitation of  $\psi/J(3100)$ .
- B. Presence of L=1 states between  $\psi/J$  and  $\psi'$ ,  $^3P_0 \chi(3415)$ ,  $^3P_1 \chi(3510)$ ,  $^3P_2 \chi(3555)$ .
- C. Presence of Pseudoscalar partners of  $\psi/J$   $\eta_c(2970)$ . The absence of  $\eta_c(2800)$  has been interpreted as a success of the model!
- D. Predictions on the cascade transition rates.  $\psi' \rightarrow \gamma\chi$ ,  $\chi \rightarrow \gamma\psi$  as  $E_1$  transitions.
- E. Ratio of leptonic widths of  $\psi'$  and  $\psi/J$ .
- F. Enhancement of R above 3.9 GeV due to opening of decay channels, i.e., charmed hadron production.
- G. Provides a framework for understanding of Okubo-Zweig-Iizuka rule; (i.e., the values of  $\Gamma_{had}(\psi_n)$  for states that are above and below bare charm threshold).

A significant extension of the model has been done by the Cornell group<sup>4</sup> by the inclusion of decay channels in the formalism. Among its claims for fame are:

Invited talk presented at the  
1979 International Conference on Two Photon Interactions  
Lake Tahoe, California

August 30 - September 1, 1979

Sponsored by the University of California at Davis



\*Work supported by the Department of Energy, contract DE-AC03-76SP00515.  
†Present address: San Jose State University, San Jose, California, 95192.

ECM

1. Prediction of the existence and width of the  $\psi''(3772)$  as a  ${}^3D_1 c\bar{c}$  state, mixed with the  $2{}^3S_1$  state.

2. Reasonable semiquantitative description<sup>3</sup> of the  $(\Delta R)_{\text{charm}}$  in the interval  $3 \text{ GeV} < W < 4.5 \text{ GeV}$ .

## II. TWO PHOTON PHYSICS

Two photon experiments are a useful laboratory to test ideas about the potential that bind the quarks. They also provide additional information about the spectrum of heavy quarks.

The one-photon sector in  $e^+e^-$  collisions will continue to be the dominant tool in the search for new flavors (b, t, ...) but

$$\sigma_{1\gamma} \sim \frac{\alpha^2}{s}$$

The two-photon sector will be competing at PEP at PETRA energies

$$\sigma_{ee \rightarrow eex} \sim \alpha^4 \ln^2 \left( \frac{s}{m_e^2} \right)$$

and it will become a useful tool to study the "old" physics like charm production.

### A. Production of $c\bar{c}$ Bound States.

The "naive" model can be used here, as it has been successfully used<sup>2</sup> in  $e^+e^- \rightarrow \gamma + \psi_n$ .

The predictions for  $\eta_c$ ,  ${}^3P_2$  and  ${}^3P_0$  are straightforward, the mechanism is described in Fig. 1, and will be extensively discussed by F. Gilman<sup>5</sup> at this conference.

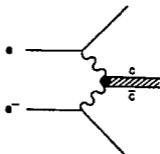

Fig. 1. Production of narrow  $c\bar{c}$  bound state via two photons.

In particular for  $\eta_c$  production we expect

$$\sigma(ee \rightarrow ee\eta_c) = \frac{16\alpha^2}{M_{\eta_c}^3} \Gamma(\eta_c \rightarrow \gamma\gamma) \ln^2\left(\frac{E}{m_c}\right) f(z) \quad (1)$$

where  $E$  is the beam energy, and  $f(z)$  is the Low function given by

$$f(z) = (2 + z^2)^2 \ln\left(\frac{1}{z}\right) - (1 - z^2)(3 + z^2) \quad (2)$$

with  $z = M_{\eta_c} / 2E$ .

The value of  $\Gamma(\eta_c \rightarrow \gamma\gamma)$  can be calculated using the nonrelativistic approximation:

$$\Gamma(\eta_c \rightarrow \gamma\gamma) = \frac{16}{27} \frac{\alpha^2}{m_c^2} \left| R_B(0) \right|^2 \quad (3)$$

where  $R_B(0)$  is the radial wave functions at the origin, and  $m_c$  the quark mass.  $R_B(0)$  is obtained from a numerical solution to the Schroedinger problem in the potential

$$V(r) = -\frac{4}{3} \frac{\alpha_B}{r} + \frac{r}{a^2} \quad (4)$$

For a typical PEP energy of  $E_{\text{beam}} = 15$  GeV values of  $\sigma(ee \rightarrow ee\eta_c)$  of 50 pb are obtained, and an order of magnitude lower for  $^3P$  states.

### B. Bare Charm Production

The diagram is shown in Fig. 2. The cross section, with no tagging of the final leptons is given by

$$\frac{d\sigma}{d\hat{s}}(ee \rightarrow eex) = 2 \frac{\alpha^2}{\hat{s}^2} \ln^2\left(\frac{E}{m_c}\right) f\left(\frac{\sqrt{\hat{s}}}{2E}\right) \frac{\sigma_{\gamma\gamma}(\hat{s})}{\hat{s}} \quad (5)$$

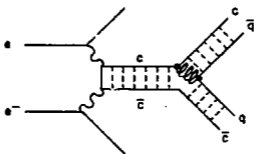

Fig. 2. Production of exclusive charmed meson channels via two photons.

where  $\sqrt{s} = W$  is the energy deposited into hadrons. Calorimetric type experiments, where both  $s$  and  $d\sigma/d\hat{s}$  are measured are the key to success in charm searches.

### III. THE MODEL

The model to be used coincides with that used by the Cornell group, and I refer to them for details. I will append here some of the main features necessary to perform this calculation, using the same nomenclature as that of Ref. 4.

The interaction Hamiltonian that incorporates Zweig allowed decays is given by

$$H_I = \frac{1}{2} \sum_{a=1}^8 \int : \rho_a(\vec{x}) V(\vec{x}-\vec{y}) \rho_a(\vec{y}) : d^3x d^3y \quad (6)$$

with  $V(\vec{x}-\vec{y})$  given by Eq. (4) and the charge density  $\rho_a$ :

$$\rho_a(\vec{x}) = \psi^\dagger(\vec{x}) \frac{\lambda_a}{2} \psi(\vec{x}) \quad (7)$$

with  $\lambda_a$ , the SU(3) Gell-Mann matrices. The terms included in the calculation are shown in Fig. 3(a-e) while the diagrams shown on Fig. 3(f,g) are neglected.

The total Hamiltonian  $H$ :

$$H = H_0 + H' \quad (8)$$

where  $H_0$  contains the portion of  $H_I$  in Eq. (6) that binds the  $c\bar{c}$  pairs into the "naive" charmonium states, both below and above threshold.

$H'$  can be divided into

$$H' = H_c + U + U^\dagger \quad (9)$$

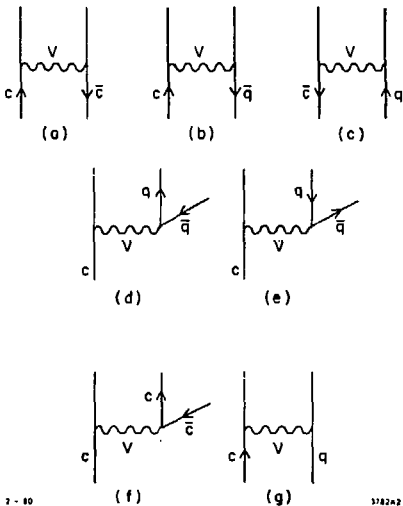

Fig. 3. Terms in  $H_1$ . Contributions due to 3a-3e are included in this calculation. Interactions shown in 3f, 3g are neglected.

where  $H_c$  contains  $c\bar{q}$  and  $\bar{c}q$  binding terms. The operator  $U$  describes the transitions  $c + c + q + \bar{q}$ . The relevant matrix elements of  $U$  are

$$\langle c\bar{c}_n | U | c\bar{q}, \bar{c}q, \alpha \rangle \quad (10)$$

where  $\langle c\bar{c}_n |$  is a bare state of fixed  $n$ ,  $S$ ,  $L$ ,  $J$ , and  $|c\bar{q}, \bar{c}q, \alpha\rangle$  contains a pair of charm mesons, and  $\alpha$  characterizes the spin parity of these states. Observe that  $U$  is related to  $H_I$  in Eq. (6) by  $U = P_0 H_I P_c$ , with  $P$  being projection operators.

The quantities of interest can be expressed in terms of the Green operator

$$\mathcal{G} = P_0 \frac{1}{z - H} P_0 \quad (11)$$

$\mathcal{G}(z)$  provides a description of the  $c\bar{c}$  sector in the presence of decay channels, and is represented in Fig. 4. Also of interest is the operator  $D(z)$ :

$$D(z) = P_c \frac{1}{z - H} P_c \quad (12)$$

The equation for  $\mathcal{G}(z)$  in the coordinate representation, in terms of the eigenfunctions  $\psi_n$  and eigenvalues  $\epsilon_n$  of the Schrodinger problem for  $H_0$  is:

$$\langle \vec{y} | \mathcal{G}(z) | \vec{x} \rangle = \sum_n \psi_n(\vec{y}) \langle n | \mathcal{G}(z) | \vec{x} \rangle \quad (13)$$

where the sum over  $n$  includes the discrete and continuous spectra and

$$\langle n | \mathcal{G}(z) | \vec{x} \rangle = \frac{\psi_n^*(\vec{x})}{z - \epsilon_n} + \frac{1}{z - \epsilon_n} \sum_{n,m} \Omega_{n,m}(z) \langle m | \mathcal{G}(z) | \vec{x} \rangle \quad (14)$$



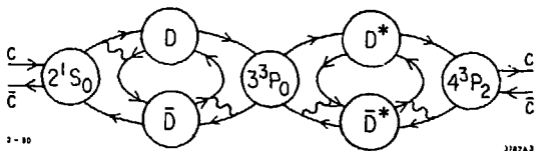

Fig. 4. The Green function  $\mathcal{G}$  of a  $c\bar{c}$  pair in the presence of open and closed decay channels.

and

$$\Omega_{n,m}(z) = \sum_{\tau} \int d^3 p_1 d^3 p_2 \frac{\langle n|U|\tau, \vec{p}_1, \vec{p}_2\rangle \langle m|U|\tau, \vec{p}_1, \vec{p}_2\rangle}{z - E_1 - E_2 - i0} \quad (15)$$

where  $(\vec{p}_1, E_1)$  specifies the four momentum of each charm meson. The expression (15) further simplifies when we restrict the final states to include only S waves  $c\bar{q}$  states and we approximate their wave functions with Gaussians. In that case

$$- \text{Im} \Omega_{n,m}^i(z) = \frac{\pi p E_1 E_2}{W} C^2 H_{n,m}^i \quad (16)$$

with the index  $i$  specifies a two-body channel (i.e.,  $D_1 \bar{D}_2$ ),  $p$  is the momentum of either meson,  $W = E_1 + E_2$ , the constant  $C^2$  is a simple function of the quark masses. The expressions for  $H_{n,m}^i$  appropriate for the calculations of total cross sections for different processes (i.e., the contributions of  $^1S_0$ ,  $^3P_0$ ,  $^3P_2$  to  $\sigma_{\gamma\gamma}$ , as well as the contributions of  $^3S_1$  to R) are given in Table I in terms of some numerical integrals  $I_L^n$ .

TABLE I

$H_{n,m}^i$  matrix elements. The last column,  $^3S_1$ , is used for the calculation of  $\Delta R$ . The  $I_L^n(p)$  are oscillating functions of  $p$  and have nodes corresponding to the radial nodes. They are computed numerically.

Intermediate State \ Final State	$^1S_0$	$^3P_0$	$^3P_2$	$^3S_1$
$D\bar{D}$	0	$I_0^{n,m}$	$\frac{2}{5} I_2^{n,m}$	$\frac{1}{3} I_0^{n,m}$
$D\bar{D}^* + D^*\bar{D}$	$4 I_1^{n,m}$	0	$\frac{6}{5} I_2^{n,m}$	$\frac{4}{3} I_0^{n,m}$
$D^*\bar{D}^*$	$4 I_1^{n,m}$	$\frac{8}{3} I_2^{n,m} + \frac{1}{3} I_0^{n,m}$	$\frac{16}{5} I_2^{n,m} + \frac{4}{3} I_0^{n,m}$	$\frac{7}{3} I_0^{n,m}$

Once we have solved for  $\text{Im}\Omega_{n,m}^1(z)$ , using Eq. (16), the real part  $\text{Re}\Omega_{n,m}^1(z)$  is obtained by a simple dispersion relation calculation.

We then proceed to solve for the resolvent  $\mathcal{G}(z)$  using Eq. (11). The eigenvalues of the coupled channel are obtained from

$$\text{Det}[(z - \epsilon_n) \delta_{n,m} - \Omega_{n,m}(z)] = 0 \quad (17)$$

The poles of  $\mathcal{G}(z)$ , solutions of Eq. (17), give us the renormalized physical masses, and for  $W > 2M_D$ , the widths of the resonances in the  $c\bar{c}$  sector are given by

$$-\text{Im } \mathcal{G}(W) = \frac{\Gamma}{2} \quad (18)$$

The expressions for the total  $\gamma\gamma$  cross section may be obtained in terms of  $\mathcal{G}, \Omega$ , and the radial wave functions of the  $c\bar{c}$  bound states  $R_{n,L}(\vec{r})$ . For the  $^1S_0$  intermediate states,

$$\sigma_{\gamma\gamma \rightarrow ^1S_0} = -\frac{2\pi}{W^2} e_c^4 \frac{\alpha^2}{m_c^2} \sum_{n,m,l} R_{n,0}^{(0)} R_{m,0}^{(0)} \langle \psi_{n0} | \mathcal{G}^\dagger \text{Im}\Omega^1 \mathcal{G} | \psi_{m0} \rangle \quad (19)$$

For the  $^3P_0$  states we have

$$\sigma_{\gamma\gamma \rightarrow ^3P_0} = -\frac{2\pi}{W^2} e_c^4 \frac{9\alpha^2}{m_c^2} \sum_{n,m,l} R_{n,l}^{(0)} R_{m,l}^{(0)} \langle \psi_{nl} | \mathcal{G}^\dagger \text{Im}\Omega^1 \mathcal{G} | \psi_{ml} \rangle \quad (20)$$

and the  $^3P_2$  contribution looks the same as the preceding equation except that  $\mathcal{G}$  and  $\Omega$  for the  $^3P_2$  channels are used and we multiply by  $(4/15)(2J+1) = 4/3$ . The  $^3P_1$  states give a small contribution; when the photons are both on shell the coupling of the  $^3P_1$  to the two photons is zero. The contribution to  $R$  from these exclusive channels is

given by:

$$\Delta R = -\frac{\beta}{W^2} \sum_{n,m,l} R_{n,0}(0) R_{m,0}(0) \langle \psi_{n0} | \mathcal{G}^{\dagger} I m \Omega^{\dagger} \mathcal{G} | \psi_{m0} \rangle \quad . \quad (21)$$

#### IV. CALCULATIONS

We used the latest published parameters of the Cornell group and made no further adjustments in these parameters. Those parameters were chosen to best describe the spacing of the narrow resonances and the  $^3S_1$  experimental data, i.e.,  $e^+e^-$  charm. The parameters are

$$\begin{aligned} m_c &= 1.84 \text{ GeV} \\ \beta &= 2.12 \text{ GeV}^{-1} \\ \kappa &= \frac{4}{3} \alpha_s = 0.52 \end{aligned} \quad (22)$$

with these parameters we numerically solve for the  $R_{n,L,t_n}$  in the Schroedinger problem in the potential given in Eq. (4). Keeping only the linear potential, we construct variational Gaussian wave functions for the charmed mesons:  $D, D^*, F, F^*$ ; with the quark masses selected by the Cornell group:

$$\begin{aligned} m_u &= m_d = 0.335 \text{ GeV} \\ m_s &= 0.45 \text{ GeV} \quad . \end{aligned}$$

These values were chosen to give:

$$\begin{aligned} m(D^0) &= 1.863 \text{ GeV} \\ m(D^+) &= 1.868 \text{ GeV} \\ m(F) &= 2.040 \text{ GeV} \quad . \end{aligned}$$

We then proceed to calculate numerically  $H_{n,m}$ ,  $\text{Im}\Omega$ ,  $\Omega$  for the  $^1S_0$  and  $^3P_J$  channels. We include intermediate states up to  $n=6$ , and final states consisting of  $D\bar{D}$ ,  $D\bar{D}^* + D^*\bar{D}$ ,  $D^*\bar{D}^*$ ,  $F\bar{F}$ ,  $F\bar{F}^* + F^*\bar{F}$ ,  $F^*\bar{F}^*$ .

We calculate the cross sections  $\sigma_{\gamma\gamma}(^1S_0)$ ,  $\sigma_{\gamma\gamma}(^3P_0)$  and  $\sigma_{\gamma\gamma}(^3P_2)$  and add them together. The resulting cross section for  $e\bar{e} \rightarrow e\bar{e} C_1 \bar{C}_2$  is plotted in Fig. 5 for a beam energy of 15 GeV.

Also shown is the cross section for producing a  $c\bar{c}$  quark pair, ignoring final state interactions. The same value of the quark mass is used. We have verified our numerical calculations against the  $\Delta R$  calculations of the Cornell group;<sup>3,4</sup> and our theoretical expressions extrapolate correctly to the narrow resonance limit.

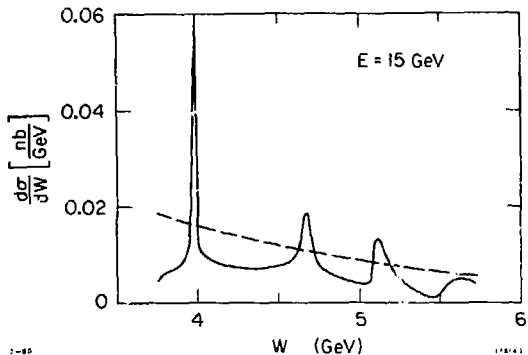

Fig. 5. The cross section  $d\sigma/dW$  for charmed meson production, summed over the channels  $D\bar{0}$ ,  $DD^* + \bar{D}\bar{D}^*$ ,  $D^*\bar{D}^*$  and the corresponding channels for  $F$ 's. The dashed line is  $d\sigma/dW$  for  $c\bar{c}$  pairs with no binding in the final state.

## V. CONCLUSIONS

The comparison of the nonrelativistic multichannel calculation with the double Rutherford process shown in Fig. 5 shows that duality is satisfied, in the sense that if one averages the actual cross sections for a wide enough range of  $W$  one gets the same result as for nonstrongly interacting pointlike quarks. See Fig. 6. It has been shown for the case of  $e^+e^-$  annihilation that duality in this sense follows from nonrelativistic potential models;<sup>6</sup> we have verified that this proof can be extended to two-photon processes.

A few further comments are in order. The cross section is measurable albeit not large. With a luminosity of  $10^{32} \text{ cm}^{-2} \text{ sec}^{-1}$  we expect one hundred events per day in a  $W$  range of 1 GeV. The main background is due to  $ee \rightarrow eeu\bar{u}$  that is shown in Fig. 7. However, this background can be considerably reduced by identifying strange particles in the final state.

One, of course, needs to use a high resolution calorimeter experiment to measure the final state energy deposited into hadrons. The requirement of low hadronic energy deposition should eliminate the low energy background. Finally, the sharp peaks observed in Fig. 5 are mainly due to P states as the S state peaks already appear to be rather broad. The information that can be obtained on the size and location of these peaks should be quite useful in further delineating the effective potential that binds heavy quarks.

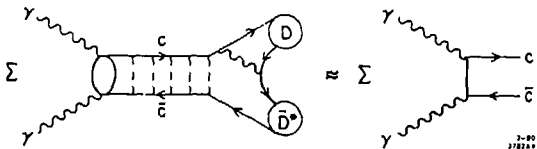

3-80  
3782A\*

Fig. 6. Duality in two-photon processes.



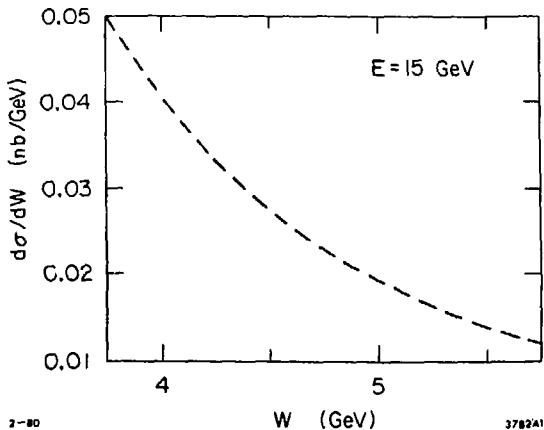

7-80

3782A1

Fig. 7. The cross section  $d\sigma/dW$  for  $e s \rightarrow e e u \bar{u}$  for the same beam energy  $E = 15$  GeV, and  $m_u = 0.335$  GeV.

REFERENCES

1. T. Appelquist and H. D. Politzer, Phys. Rev. Lett. 34, 43 (1975).
2. E. Eichten, et al., Phys. Rev. Lett. 34, 369 (1975); ibid 36, 500 (1976).
3. K. D. Lane and E. Eichten, Phys. Rev. Lett. 37, 477 (1976).
4. E. Eichten, K. Gottfried, T. Kinoshita, K. D. Lane and T. M. Yan, Phys. Rev. D17, 3090 (1978); ibid D21, 203 (1980).
5. F. Gilman in "Production of Resonances in Photon-Photon Collisions," Report No. SLAC-PUB-2461, invited talk at this conference.
6. J. S. Bell and J. Pasupathy, Phys. Lett. 83B, 389 (1979);  
C. Quigg and J. Rosner, Phys. Rev. D17, 2364 (1978);  
M. Kramer and P. Leal-Ferreira, Rev. Bras. Fis. 9, 7 (1976).