

1 N 1 5
TRIN 708105558

AAEC/E511



AAEC/E511

AUSTRALIAN ATOMIC ENERGY COMMISSION
RESEARCH ESTABLISHMENT
LUCAS HEIGHTS

IN-SITU DETERMINATION OF MOISTURE IN ROAD PAVEMENT
BY NUCLEAR METHODS

by

G.W. GRAY
B.D. SOWERBY
G.P. YOU DALE*

*Department of Main Roads

April 1981

ISBN 0 642 59710 3

AUSTRALIAN ATOMIC ENERGY COMMISSION
RESEARCH ESTABLISHMENT
LUCAS HEIGHTS

IN-SITU DETERMINATION OF MOISTURE IN ROAD PAVEMENT
BY NUCLEAR METHODS

G.W. GRAY
B.D. SOWERBY
G.P. YOUNG*

ABSTRACT

The use of neutron moisture probes to determine moisture in compacted pavement layers has been studied at the AAEC Research Establishment on samples representative of those used by the New South Wales Department of Main Roads (DMR) for roadway construction. The aim of this work was to measure the average moisture content of the upper layer (15-20 cm thick) with minimum interference from moisture in underlying layers.

Sub-surface probes using high (α -Be) and low (α -Li) energy neutron sources were examined; conventional α -Be sources in specially designed compact probes should result in an error due to base moisture and density variations of less than 0.4 wt % moisture. As this error is probably less than those due to sampling and geometry variations in the field, such a probe should be sufficiently accurate for DMR requirements. If less sensitivity to base moisture is required, the α -Li source will reduce this sensitivity by a factor of about 1.4.

* Department of Main Roads, Materials and Research Laboratory, 28 Ennis Road, Milsons Point, NSW, 2061

National Library of Australia card number and ISBN 0 642 59710 3

The following descriptors have been selected from the INIS Thesaurus to describe the subject content of this report for information retrieval purposes. For further details please refer to IAEA-INIS-12 (INIS: Manual for Indexing) and IAEA-INIS-13 (INIS: Thesaurus) published in Vienna by the International Atomic Energy Agency.

MOISTURE GAGES; SOILS; HUMIDITY; NEUTRON SOURCES; PROMPT NEUTRONS;
QUANTITATIVE CHEMICAL ANALYSIS

CONTENTS

1. INTRODUCTION	1
2. MOISTURE MEASUREMENT	1
3. NEUTRON MOISTURE GAUGES	2
4. POSSIBLE IMPROVEMENTS TO REDUCE PENETRATION	3
5. SAMPLE DETAILS	3
6. EXPERIMENTAL METHOD	4
7. RESULTS	4
8. DISCUSSION	5
9. ACKNOWLEDGEMENT	6
10. REFERENCES	6
Table 1 Properties of some Commercially Available Radioisotope Neutron Sources	9
Table 2 Summary of Sample Details for the Nominal 15 cm Thick Samples and Results Obtained with ^3He Detector and $\alpha\text{-Li}$ and $\alpha\text{-Be}$ Neutron Sources	9
Table 3 Some Details of the Radioisotope Neutron Sources used in the Present Experiments	10
Table 4 Summary of Regression Fits for Ten DMR Samples on Bases of Dry Sand and Water Respectively	10
Table 5 Summary of Increases in Calculated Moisture Contents for Various DMR Samples on a Water Base Compared to those with a Dry Sand Base	10

(Continued)

CONTENTS (Continued)

Figure 1	The calculated fraction of neutron flux at the centre of a sphere which originates within a sub-sphere of radius R	11
Figure 2	The calculated 'spheres of influence' within which originate 50, 80 and 95% of the thermal neutron flux measured at the centre of the sphere. The calculations were performed assuming a bulk density of 2.1 g cm^{-3} and a moisture content of 10 wt %. Neutron leakage at the surface has been neglected	12
Figure 3	Scale drawing of one of the sub-surface probes used in the present work	13
Figure 4	Density and moisture contents of 10 of the 11 DMR 15 cm thick samples supplied. The numbers shown on the graph are the DMR sample numbers. Sample number 11 had a dry density of 1.00 g cm^{-3} and a moisture content of 22.2%	14
Figure 5	Measured ^3He count rates for the 15 cm thick DMR samples on sand and water bases	15
Figure 6	Calculated versus measured moisture contents for the probe containing the $^{241}\text{Am-Li}$ source and ^3He detector. The calculated moisture content was determined from the measured ^3He count rate and the wet bulk density value supplied by the DMR	16
Figure 7	Measured ^3He count rates for DMR sample number 2 using the other 10 DMR samples as bases	17

1. INTRODUCTION

Knowledge of the moisture conditions in road pavements is essential at the design and construction stages. The thickness of a pavement that must be constructed over a given subgrade is very sensitive to the moisture content of that subgrade [DMR 1980]. Road pavement is constructed in layers of thickness 15-20 cm which are successively compacted. The successful construction of the pavement layers is largely dependent on controlling the moisture content of these layers to within a narrow range so that the desired bulk density can be reached with the minimum amount of compaction. Consequently there is a need for the development of a device which rapidly measures the moisture content of the upper pavement layer. This device should be insensitive to the moisture content of the underlying layers and to surface effects. If combined with a density measuring instrument it would be a powerful tool for the quality control of pavements during construction.

2. MOISTURE MEASUREMENT

The New South Wales Department of Main Roads (DMR) usually measures moisture content by weighing a sample of wet material, drying it and then calculating the moisture content as a percentage of the mass of water to the mass of dry soil. Methods of drying the soil include the use of an oven at a temperature between 105 and 110°C, a hot plate or a sand bath, and burning off with methanol [DMR 1974]. The dry bulk density is usually determined by combining a measurement of wet bulk density with a measurement of moisture [DMR 1976]. Attempts have also been made to measure moisture conditions in terms of the energy of the soil moisture (negative pore water pressures) using matrix potential sensor probes and psychrometers, but this work has been largely for research [Lee 1974].

Commercial nuclear gauges are available which measure wet bulk density by 45° γ -ray transmission and moisture by surface neutron backscatter from an α -Be neutron source. However, surface moisture gauges preferentially 'see' the top of the layer, about 50 per cent of the response coming from the top 3.5 cm. It is this surface layer which is most affected by weather conditions and, therefore, is not representative of the layer of interest. The alternative, the sub-surface neutron moisture probe, has the disadvantage of too much penetration with the result that it is too sensitive to moisture in the underlying layers.

In the present work, the use of various neutron moisture probes to analyse average moisture in a 15 cm thick, compacted roadway surface layer is examined.

3. NEUTRON MOISTURE GAUGES

A neutron moisture gauge contains a fast neutron source and a slow neutron detector. The fast neutrons penetrate the sample and collide with its atoms. Essentially, the neutrons lose their energy by collisions with hydrogen atoms and are scattered without substantial loss of energy by heavier atoms. When most of the hydrogen is present in the form of water, the technique can be used to measure moisture content [IAEA 1970; Zuber and Cameron 1966].

Neutron moisture gauges usually contain a sealed source of an α -emitter (e.g. ^{241}Am , ^{226}Ra) mixed with Be. Neutrons from these sources range in energy from 0 to 11 MeV, and have an average energy of about 5 MeV. Slow neutron detectors are usually either gas-filled proportional counters (BF_3 or ^3He) or Li-loaded scintillators.

As pointed out in Section 2, the volume measured by the neutron moisture gauge is of prime importance in the present application. Calculations of this volume have been reported by a number of authors [IAEA 1970; Czubek 1968; Ølgaard 1965]. These calculations show that the volume of soil which is traversed by neutrons as they slow down and diffuse decreases with increasing moisture content and with increasing soil bulk density. The calculated fraction of neutron flux at the centre of a sphere which originates within a sub-sphere of radius R is shown in Figure 1. These fractions were calculated for a sample of bulk density 2.1 g cm^{-3} , moisture content 10 wt % and a neutron absorption cross section of $0.005 \text{ cm}^2 \text{ g}^{-1}$.

The calculated depth response for the DMR geometry is shown in Figure 2 which indicates that, assuming a point source and point detector, approximately 80 per cent of the detected neutrons originate in the uppermost 15 cm layer and about 20 per cent originate in the underlying layer. However, there will be appreciable neutron leakage through the roadway surface. Note that the 'spheres of influence' shown in Figure 2 will shrink for higher and expand for lower density and moisture. The moisture gauge should therefore be calibrated in a similar geometry to that used for field measurements.

4. POSSIBLE IMPROVEMENTS TO REDUCE PENETRATION

The following discussion relates only to sub-surface probes as surface gauges do not have sufficient penetration for the present DMR application. A scale drawing of one of the sub-surface probes used in the present work is shown in Figure 3. This probe incorporates a ^{239}Pu -Be source and a ^3He detector.

When using this type of probe, the following methods could be used to reduce depth penetration:

- (a) Shrink the geometry vertically either by reducing the length of source and/or detector or by placing an annular source around the centre of a short neutron detector. The depth response of a shortened probe will more closely approximate the response shown in Figures 1 and 2.
- (b) Surround the detector with cadmium sheet so that only epithermal neutrons are detected. The depth response depends on migration length which is equal to $\sqrt{L_s^2 + L^2}$, where L_s = moderation length and L = diffusion length (thermal neutrons). For epithermal neutrons $L = 0$. However, since for most soils $L_s > 2L$, only a small improvement is gained by using a cadmium sheet.
- (c) Reduce the moderation length L_s by using a neutron source of lower energy. The characteristics of four commercially available radioisotope neutron sources are shown in Table 1. Because of its high γ -ray flux, the ^{124}Sb -Be source is unsuitable for this type of application. Instead, a ^{241}Am -Li source was chosen for its excellent characteristics of a long half-life, relatively low neutron energy and low γ -ray flux. Simple calculations indicated that such a source reduces the depth penetration by about half compared to ^{241}Am -Be.

5. SAMPLE DETAILS

Compacted samples were prepared by the DMR from pavement materials typical of those used in roadway construction in New South Wales. The samples were prepared with density and moisture in the ranges found in practice, namely 1.9

to 2.3 g cm^{-3} and 5 to 14 wt % respectively. Details of the eleven samples are given in Table 2 and Figure 4. Of these samples, No.11 was included for comparative interest only; it is a new material from power stations and is as yet not widely used for road construction. Also, the bulk density and moisture content of sample 11 is well outside the ranges quoted above.

Samples were compacted in cylindrical aluminium containers of diameter 50 cm and thickness 15 cm with a 2.8 cm central hole for insertion of the probe. The samples were compacted with a Kanga Model 628 demolition hammer fitted with a 10 cm diameter compaction foot. The samples were wetted to the required moisture content, and weighed and compacted systematically to ensure uniform density. A specially made jig and screeder ensured that the central hole remained concentric during compaction, and also that the correct volume was obtained. The container was then closed with an aluminium lid sealed with silicone to prevent moisture loss. The finished samples were weighed to check the density.

6. EXPERIMENTAL METHOD

Measurements were performed on each of the samples on both dry sand and water bases. The cylindrical bases of diameter 62 cm and thickness 30 cm were located on bench tops approximately 1 m above the laboratory floor to reduce the scattering of neutrons back into the assembly. Experiments were done with the three neutron sources described in Table 3 in combination with ^3He and BF_3 detectors. The detectors were of identical dimensions and the measurement geometry was similar to that shown in Figure 3. The gas pressures in the ^3He and BF_3 detectors were 400 kPa and 53 kPa respectively. The count rate measured with the ^3He counter was about a factor of seven higher than that obtained with the BF_3 counter. Counting times were usually 5-10 minutes per sample. In addition, the effect of base material was measured with a $^{241}\text{Am-Li}$ source and ^3He detector probe using sample 2 on base materials of samples 1 and 3 to 11.

7. RESULTS

The ^3He count rates for all the DMR samples on sand and water bases are listed in Table 2 and plotted in Figure 5. Regression fits to these data (excluding sample 11) were performed with and without a density term and the

results are summarised in Table 4. These results show that moisture can be determined to within about 0.7 to 1.0 wt % using a density term and about 1.7 wt % without a density term. Plots of calculated versus measured moisture for the $^{241}\text{Am-Li}$ source and ^3He detector are shown in Figure 6. Possible contributions to the r.m.s deviations in Table 4 are (i) geometry variations, particularly in the sample immediately adjacent to the probe and in the flatness of the sample base, (ii) errors in the moisture and density values supplied by the DMR, and (iii) variations in neutron absorption cross section of the samples.

To estimate the increase in measured moisture content of the DMR samples on the water base, the moisture values have been calculated using the calibration equations for the sand base (Table 4). The average increases in measured moisture when the sample was transferred from a dry sand base to a water base are summarised in Table 5. As was expected, the moisture contents measured with the $^{241}\text{Am-Li}$ source were less sensitive to base material than those measured with the $^{239}\text{Pu-Be}$ source. The average increase when transferred from sand to a water base was 0.8 wt % with $^{241}\text{Am-Li}$ and 1.2 wt % with $^{239}\text{Pu-Be}$. The lower energy neutron source reduced sensitivity to base material by a factor of about 1.4 for sandstone and 1.2 for breccia, as shown in Table 5.

Results with the BF_3 detector were similar to those obtained with ^3He . Results with the $^{124}\text{Sb-Be}$ source showed no improvement over those obtained with $^{241}\text{Am-Li}$.

The comparison of count rates with DMR samples placed on sand and water bases is an extreme case. A more realistic experiment was performed by measuring the count rates with the $\alpha\text{-Li}$ source and ^3He detector from a single 15 cm thick sample using the other 10 samples as bases. The results of this experiment are shown in Figure 7. The count rate with the various bases was constant to within about ± 1.5 counts s^{-1} which is equivalent to a moisture variation of only 0.26 wt %.

8. DISCUSSION

A sub-surface neutron moisture probe similar to that shown in Figure 3 would be suitable for use by the DMR. The probe should incorporate a neutron source having an output of about 5×10^4 neutrons s^{-1} with a ^3He detector of

length ≤ 7.6 cm. The gas ^3He is preferred to BF_3 because of its higher sensitivity and reduced counting statistical errors.

The results of the present work indicate that the depth penetration of a neutron moisture gauge can be reduced by using a lower energy neutron source based on the $\alpha\text{-Li}$ reaction rather than the more usual $\alpha\text{-Be}$ neutron source. For the measurement of moisture in 15 cm thick roadway pavements, the sensitivity of the probe to base moisture is reduced by a factor of about 1.4 using the lower energy neutron source. However, an $\alpha\text{-Li}$ source of output 5×10^4 neutrons s^{-1} costs almost \$A1000 more than an $\alpha\text{-Be}$ source having the same neutron output. Also, the moisture content measured with the $\alpha\text{-Li}$ probe varies by only 0.26 wt % for a variety of base materials containing 5-20 wt % moisture and with dry bulk densities in the range 1.67 to 2.20 g cm^{-3} . The equivalent variation using the $\alpha\text{-Be}$ probe will be a factor of 1.4 higher than this, i.e. about 0.4 wt % moisture. This 0.4 wt % error will probably be less than those due to sampling and geometry variations in the field. Therefore it appears that adequate accuracy should be obtained for the DMR application using a compact sub-surface probe incorporating an $\alpha\text{-Be}$ neutron source.

9. ACKNOWLEDGEMENT

The work described above was initiated in discussions with A. Leask and D. Medbury of the NSW Department of Main Roads. Their contribution is gratefully acknowledged.

10. REFERENCES

- Czubek, J.A. [1968] - The Range of Nuclear Measurements for Soil Moisture and Density. AEC-tr-6931/4-5, pp.151-167.
- DMR [1974] - Department of Main Roads Test Methods, T120, T121 and T122.
- DMR [1976] - Department of Main Roads Test Methods, T119 and T125.
- DMR [1980] - Pavement Thickness Design. Department of Main Roads Report MR Form 76.

IAEA [1970] - Neutron Moisture Gauges. Technical Reports Series No.112,
International Atomic Energy Agency, Vienna.

Lee, I.K. [1974] - Soil Mechanics, Selected Topics. Newnes-Butterworths,
London.

Ølgaard, P.L. [1965] - On the Theory of the Neutronic Method for Measuring the
Water Content in Soil. Riso Report No.97.

Zuber, A. and Cameron, J.F. [1966] - Neutron Soil Moisture Gauges. Atomic
Energy Review, 4 (4) 143.

TABLE 1
 PROPERTIES OF SOME COMMERCIALY AVAILABLE RADIOISOTOPE
 NEUTRON SOURCES

Source Type	Half-life	Neutron Output (n s ⁻¹ GBq ⁻¹)	Y-ray Exposure for 10 ⁶ n s ⁻¹ source (μSv h ⁻¹)	Approx. Mean Neutron Energy (MeV)	Approx. Maximum Neutron Energy (MeV)
²⁴¹ Am-Be	458 y	5.9 x 10 ⁵	< 10	5	11
²⁵² Cf	2.6 y	1.2 x 10 ⁸	0.76	2	6
²⁴¹ Am-Li	458 y	1.1 x 10 ³	< 10	0.5	1.3
¹²⁴ Sb-Be	60 d	3.5 x 10 ⁴	8000	0.024	0.026

TABLE 2
 SUMMARY OF SAMPLE DETAILS FOR THE NOMINAL 15 cm THICK SAMPLES
 AND RESULTS OBTAINED WITH ³He DETECTOR AND
 α-Li and α-Be NEUTRON SOURCES

No.	Sample Type*	DMR Sample Data			Count Rates with α-Li Source (counts s ⁻¹)		Count Rates with α-Be Source (counts s ⁻¹)	
		Moisture (dry wt %)	ρ (dry) g cm ⁻³	ρ (wet) g cm ⁻³	Sand base	Water base	Sand base	Water base
1B	S	10.4	1.932	2.133	53.6	62.2	1357	1601
2B	S	8.9	2.008	2.186	48.9	55.3	1251	1542
3C	B	10.5	2.116	2.338	74.2	77.0	1949	2062
4C	S	5.8	1.952	2.065	29.4	38.3	672	1036
5C	B	6.9	2.201	2.353	47.6	53.4	1173	1378
6C	B	5.0	2.124	2.230	39.5	44.2	954	1137
7C	C/S	14.7	1.856	2.129	72.6	79.6	1909	2021
8C	C	19.8	1.668	1.998	104.5	95.1	2720	2743
9C	B	8.6	2.125	2.308	61.8	64.6	1618	1652
10C	S	8.4	1.953	2.117	37.8	46.5	924	1244
11C	A	22.2	1.00	1.225	42.0	47.8	939	1194

* S = sandstone
 B = breccia

C = clay
 A = bottom ash

TABLE 3
SOME DETAILS OF THE RADIOISOTOPE NEUTRON SOURCES
USED IN THE PRESENT EXPERIMENTS

Source	$^{239}\text{Pu-Be}$	$^{241}\text{Am-Li}$	$^{124}\text{Sb-Be}$
Activity (GBq)	37	37	3.7
Neutron output (neutrons s^{-1})	1.5×10^6	4×10^4	5×10^4
<u>Dimensions:</u>			
Diameter (mm)	25.4	22.4	23.0
Length (mm)	35.6	31.0	76.0
Approx. cost (\$A)	1000	1060	-

TABLE 4
SUMMARY OF REGRESSION FITS FOR TEN DMR SAMPLES ON BASES OF DRY
SAND AND WATER RESPECTIVELY.

Regression equations of the form $a + b\rho + cx$ where a,b,c
are coefficients, ρ = wet density (g cm^{-3}) and x
is the measured count rate using the ^3He detector

	α -Li Source		α -Be Source	
	Sand Base	Water Base	Sand Base	Water Base
<u>With density term</u>				
r.m.s deviation (% H_2O)	1.01	0.67	0.96	0.86
Coefficients a	28.03	26.02	29.99	21.19
b	-12.78	-13.46	-13.34	-10.82
c	0.172	0.2157	0.00623	0.00753
<u>Without density term</u>				
r.m.s deviation (% H_2O)	1.75	1.70	1.79	1.47

TABLE 5
SUMMARY OF INCREASES IN CALCULATED MOISTURE CONTENTS FOR
VARIOUS DMR SAMPLES ON A WATER BASE COMPARED TO THOSE WITH
A DRY SAND BASE.

Calculations were performed using the calibration
equations in Table 4 for samples on a dry sand base

Samples	Number of Samples	Moisture Increase (wt %)		Ratio (α -Be)/(α -Li)
		α -Li Source	α -Be Source	
All samples	11	0.82	1.2	1.41
Breccia only	4	0.69	0.83	1.20
Sandstone only	4	1.4	1.9	1.36

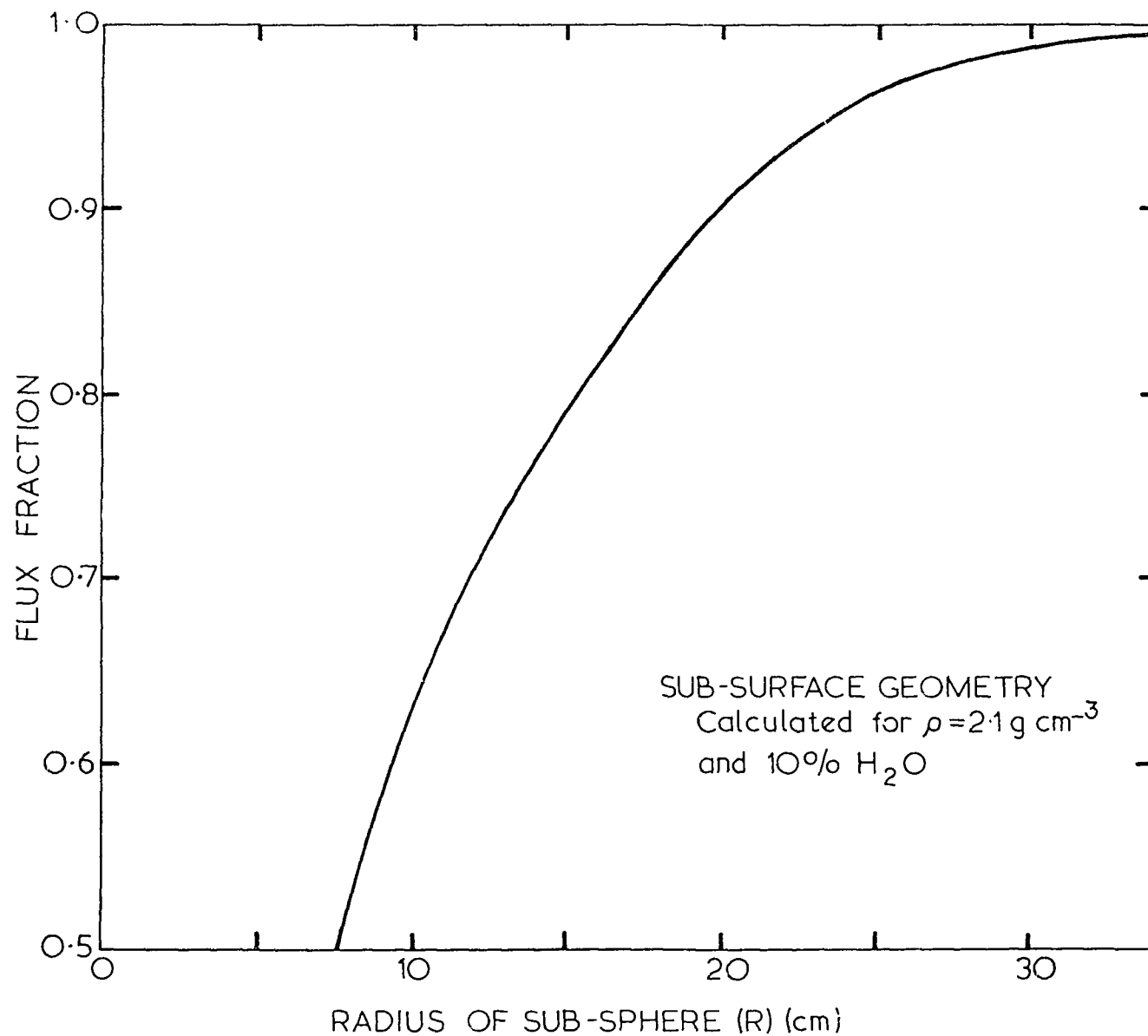

Figure 1. The calculated fraction of neutron flux at the centre of a sphere which originates within a sub-sphere of radius R

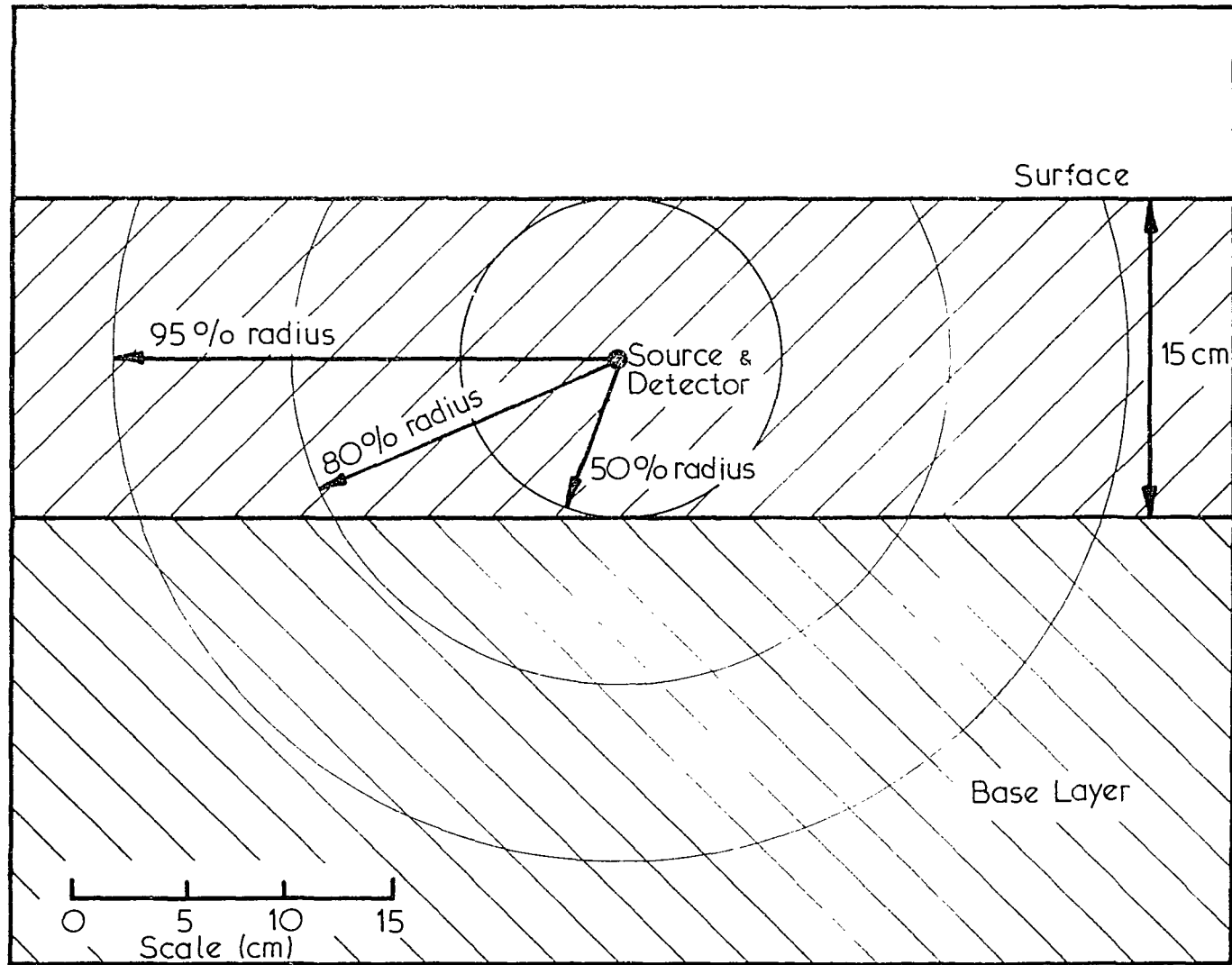

Figure 2. The calculated 'spheres of influence' within which originate 50, 80 and 95% of the thermal neutron flux measured at the centre of the sphere. The calculations were performed assuming a bulk density of 2.1 g cm^{-3} and a moisture content of 10 wt %. Neutron leakage at the surface has been neglected

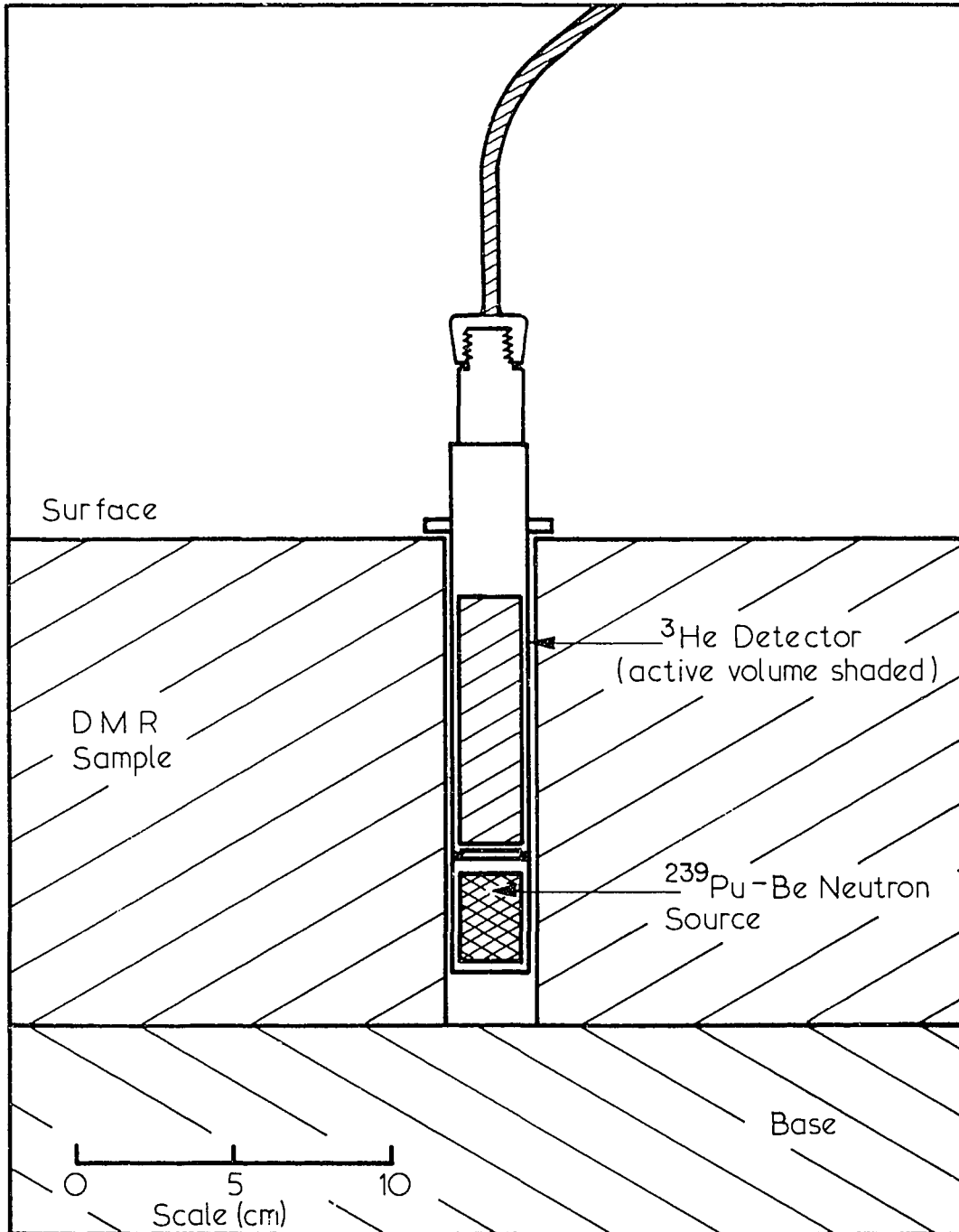

Figure 3. Scale drawing of one of the sub-surface probes used in the present work

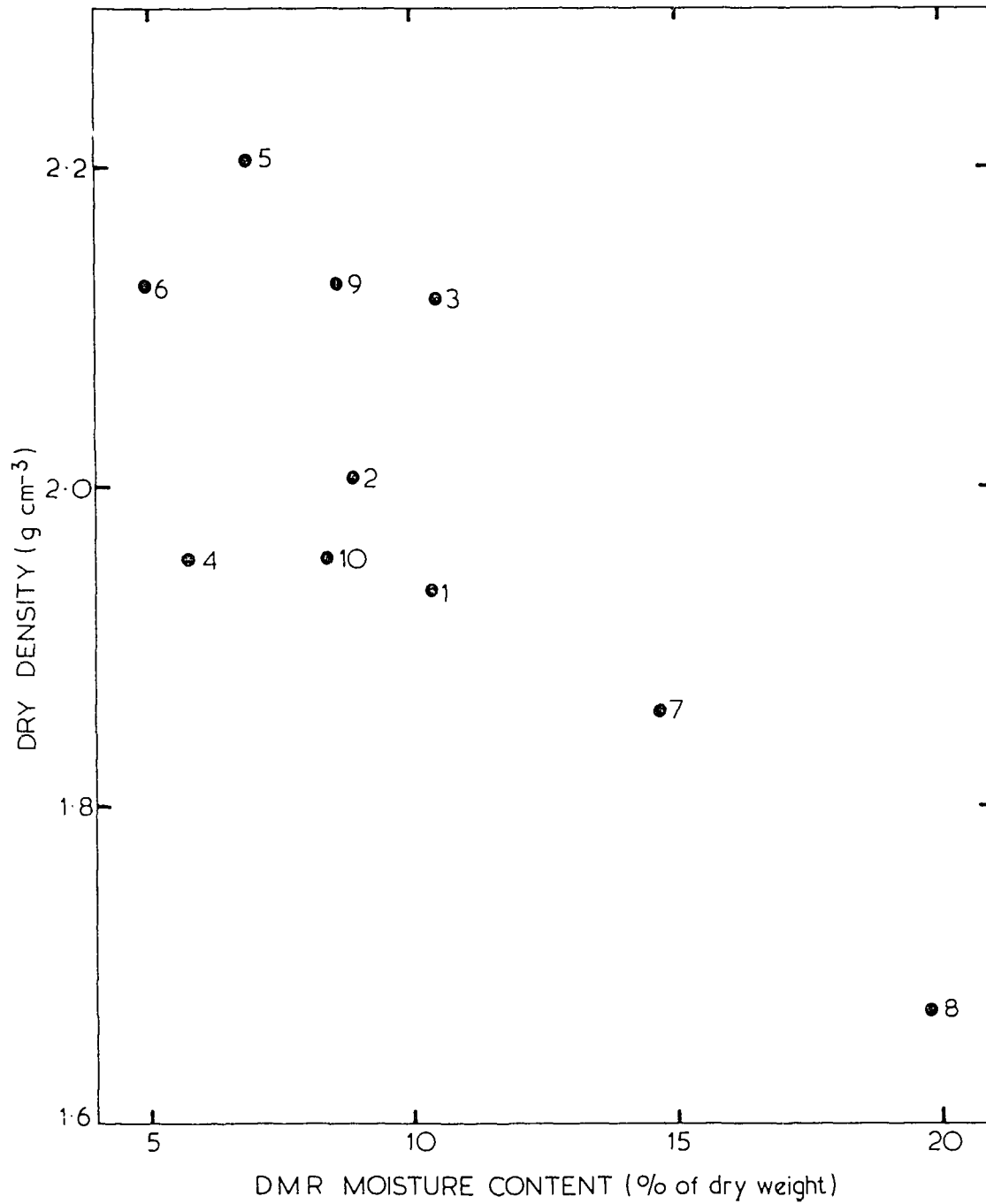

Figure 4. Density and moisture contents of 10 of the 11 DMR 15 cm thick samples supplied. The numbers shown on the graph are the DMR sample numbers. Sample number 11 had a dry density of 1.00 g cm^{-3} and a moisture content of 22.2%

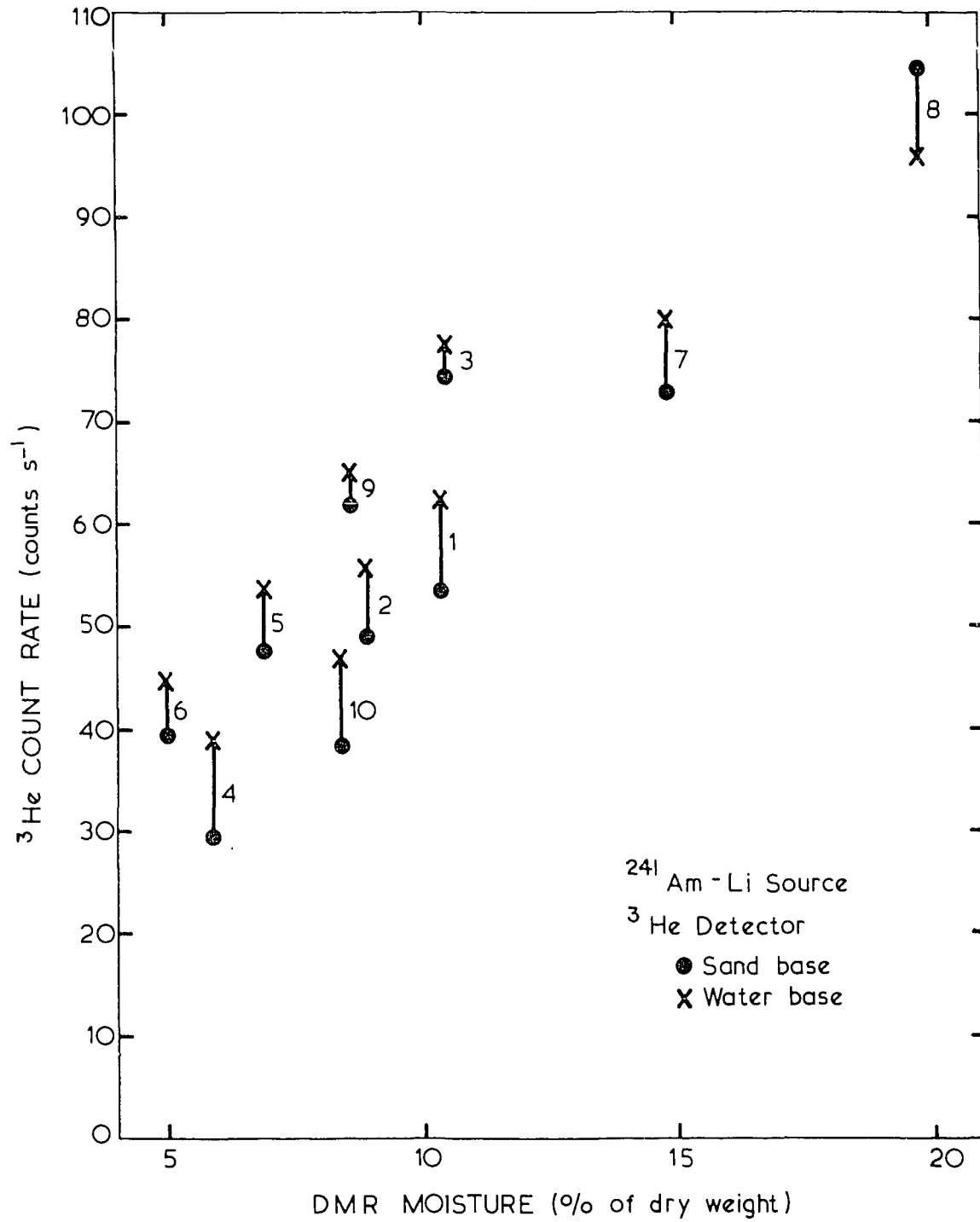

Figure 5. Measured ^3He count rates for the 15 cm thick DMR samples on sand and water bases

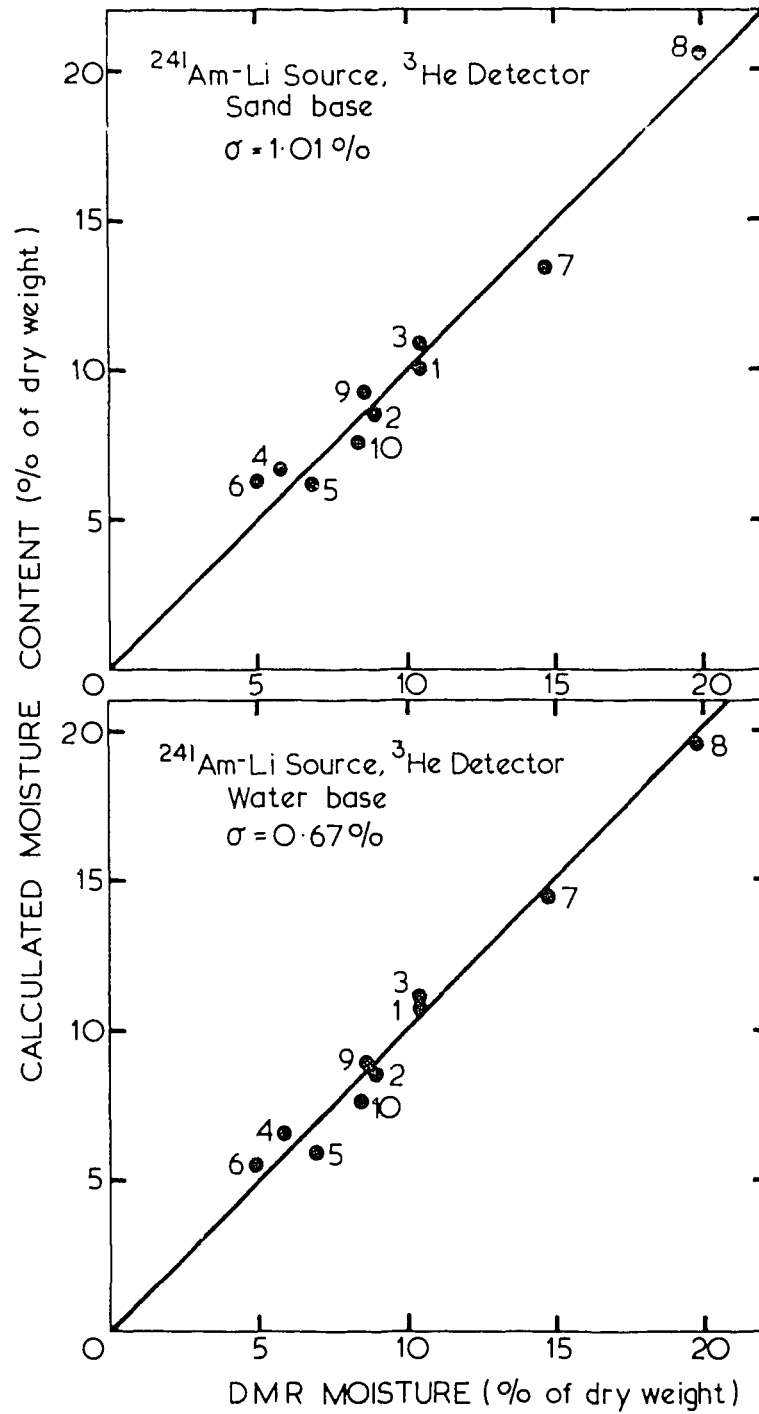

Figure 6. Calculated versus measured moisture contents for the probe containing the $^{241}\text{Am-Li}$ source and ^3He detector. The calculated moisture content was determined from the measured ^3He count rate and the wet bulk density value supplied by the DMR

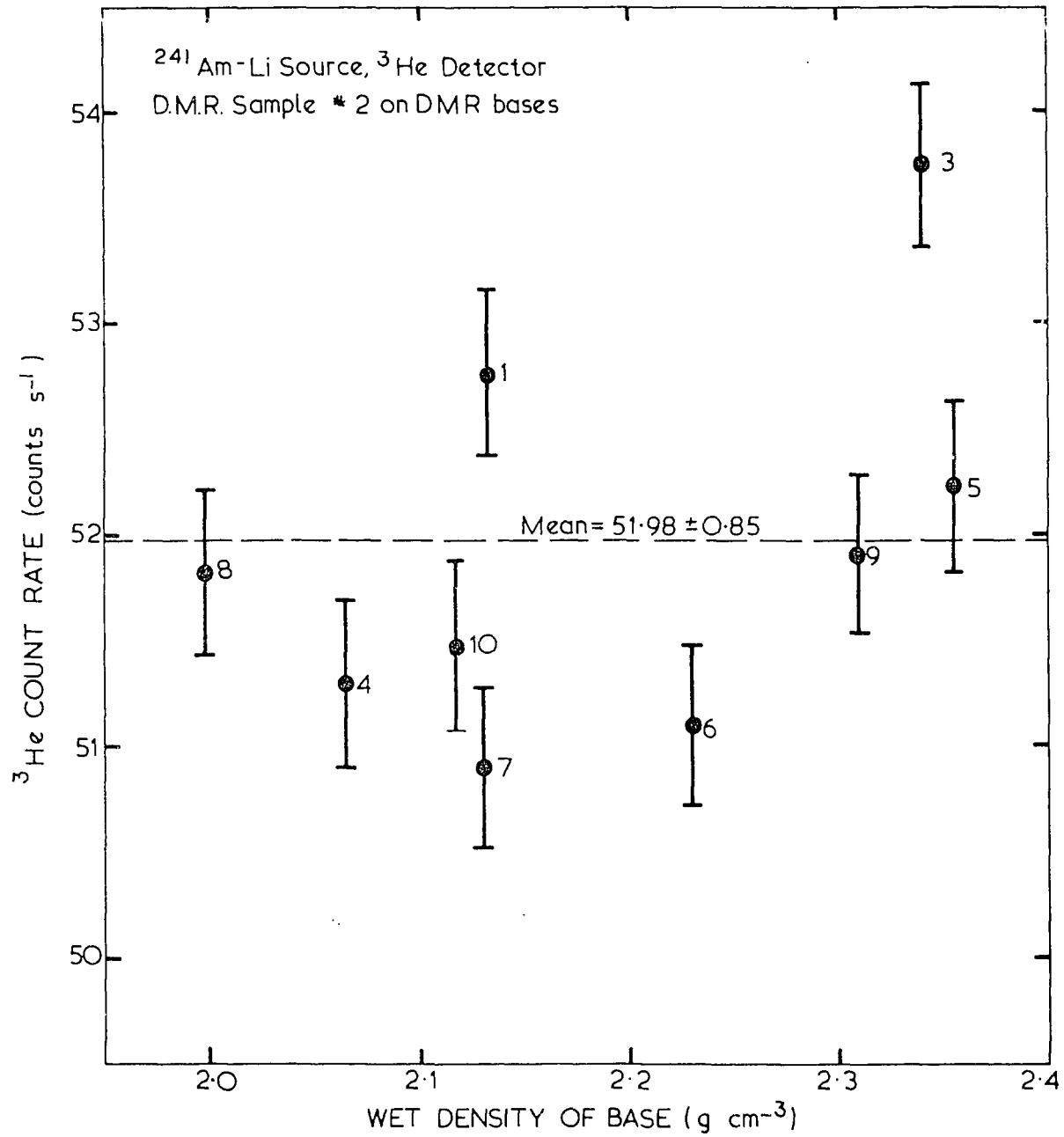

Figure 7. Measured ^3He count rates for DMR sample number 2 using the other 10 DMR samples as bases



