

LBL--14341

DE82 018524

Berkeley Research Program on Ion-Induction Linacs
for Inertial Fusion*

D. Keefe and S. S. Rosenblum

March 1982

Accelerator and Fusion Research Division
Lawrence Berkeley Laboratory
University of California
Berkeley, California 94720

DISCLAIMER

This report was prepared as an account of work sponsored by an agency of the United States Government. Neither the United States Government nor any agency thereof, nor any of their employees, making warranty, express or implied, or assumes any legal liability or responsibility for the accuracy, completeness, or usefulness of any information, apparatus, product, or process disclosed, or represents that its use would not infringe privately owned rights. Reference herein to any specific commercial product, process, or service by trade name, trademark, manufacturer, or otherwise, does not necessarily constitute or imply its endorsement, recommendation, or approval by the United States Government or any agency thereof. The views and opinions of authors expressed herein do not necessarily state or reflect those of the United States Government or any agency thereof.

DISTRIBUTION OF THIS DOCUMENT IS UNLIMITED
MJP

Presented at the Symposium on Accelerator Aspects of Heavy Ion Fusion,
Darmstadt, March 29 - April 2, 1982.

*This work was supported by the Assistant Secretary for Defense Programs,
Office of Inertial Fusion, Laser Fusion Division, U.S. Department of Energy,
under Contract No. DE-AC03-76SF00098.

Berkeley Research Program on Ion-Induction Linacs
for Inertial Fusion*

D. Keefe and S. S. Rosenblum

A. Induction Linac Technology

A.1. Driver Studies

Simultaneous acceleration of several separately-focused beams through an induction linac has a number of advantages for a heavy-ion driver. Figure 1 indicates schematically parameters developed for a 3 MJ induction linac driver that uses four beams focused entirely by magnetic quadrupole lenses from the 3 MeV injection point on.¹ Use of four beams rather than one gives a cost saving, allows a more favorable "launching" scenario (during which the process of current amplification is begun), leads to less longitudinal space-charge defocusing at the bunch ends and, finally, eases the longitudinal stability requirement. If ballistic focusing in vacuum is desired for the final propagation of the ions to the target, each of the four beamlets must be subdivided into four more to give a total of 16 beams entering the reactor. Cost studies with a computer-assisted design model² show there are additional cost savings in the early stages of the accelerator if a substantially greater number of beams is used. In one example, use of 256 electrostatically-focused beams showed cost savings at least up to the 1 GeV point; the design, however, called for unreasonably large insulators to accommodate the beams and an undesirable departure from the "electrostatic-column"-like geometry of the usual induction linac.

A. R^+ - LINAC / STORAGE RINGS.

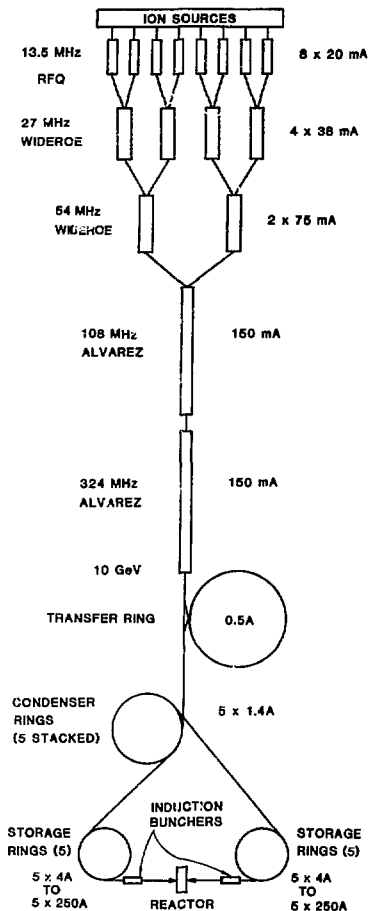

B. INDUCTION LINAC

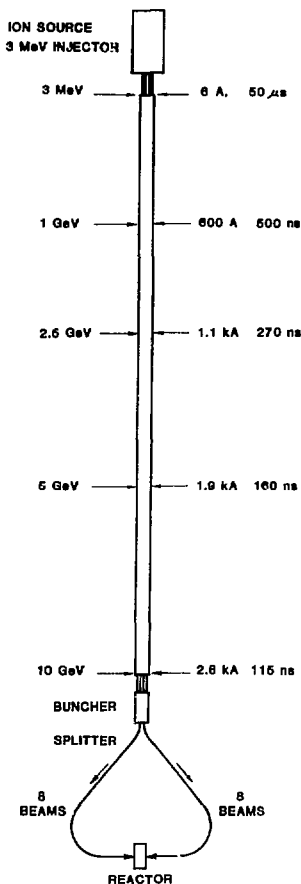

XBL 825-9767

Fig. 1 Schematic of two proposed accelerator driver systems: a) on the left, the proposed 7MJ driver for HIBALL, b) on the right, a single-pass four beam induction linac (3MJ).

If a large number (e.g. ~ 100) of electrostatically-focused beams are used to ease the design of the low-energy end of the accelerator, studies show that it is desirable to merge sub-sets of the beams at an energy of a few hundred MeV and continue acceleration with a smaller number of magnetically-focused beams. Such merging inevitably leads to some dilution of the transverse emittance. On the other hand, acceleration of a small number of beams--for example, the four-beam case shown in Fig. 1--requires septum splitting of each beam after acceleration--a manipulation that also engenders emittance dilution. However, the consequences of the split just prior to the final focusing lenses are less severe than in a case where the split is followed by a long transport line. Currently under study, therefore, is a driver example that relies on exactly sixteen beams from start to finish, and avoids the extra dilution that inevitably accompanies either beam-merging or beam-splitting.

A.2. Review of Status of Induction Linac Technology

Although the new electron induction linacs, the just completed FXR and the ATA which is under construction at LLNL, greatly extend induction linac operating parameters, to 500 GW peak and 125 kW average beam power, the existing technology base is limited and may be greatly improved for heavy ion induction linacs. Induction linac engineering can be divided into two parts--components and systems. Under components, one considers modules, beam transport elements, vacuum system and accelerator control. Because the last three are standard components in many accelerators, we will concentrate on the heart of the ion induction linac, the accelerating module. This consists of three basic parts: the magnetic core, the vacuum insulator, and the modulator. In these three areas we will discuss the present state of the

art and some new developments which could significantly reduce the cost of a heavy ion driver induction linac.

A.2.1 Core Materials

Although ferromagnetic alloy ribbons, such as nickel-iron and silicon-steel, and ferrites have been manufactured for a long time, a new class of materials based on rapid quenching of a mixture of Fe, Ni, or Co with metalloids such as Si, C, or B, has been actively pushed towards commercialization under the trade name Metglas[®] by Allied Chemical Corporation in the U.S. Although they are mainly interested in the larger market represented by distribution transformers for 60 Hz service in the electric power industry and for low-loss electric motors, the material is almost ideally suited for use in an induction linac. It has a much higher resistivity than metallic alloys (2.5 times that of 3 percent Si-Fe) and is produced in ribbons of thickness of about 10-20 μm very easily; both of these factors help in reducing eddy-current losses. Figure 2 shows a comparison of several materials using data on pulsed behavior measured at LBL. To put all the materials on a common footing, we have assumed that they will be used to make an induction module 1 meter long with 15 cm inner radius and 0.5 volt-second flux change. This normalizes the energy loss per pulse for the different materials. From this comparison one sees that, of the modules represented, the unit containing Metglas[®] would require less drive power than would those that use steel.

In a recent publication Allied Chemical has projected prices as low as \$3/kg by 1986.³ The present price of \$20/kg is already interesting for laboratory use, and production this year is expected to exceed 30 tons. At present, Allied Chemical has a large pilot plant which can produce roughly 4000 kg/hour. Some of the large transformers they have made as demon-

Accelerator Module Materials Comparison
 Module specifications 15cm inner radius
 0.5 volt-second flux change
 1 meter length

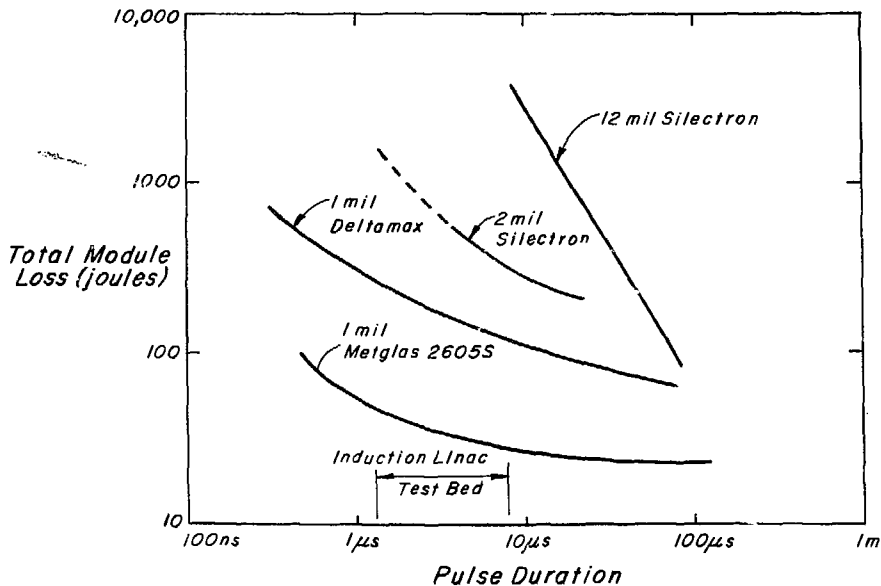

XBL 7912-13582

Fig. 2 Accelerator module ferromagnetic materials comparison. Of the materials shown the 1 mil Metglas [®] 2605SC is clearly the best material in the range.

strations have fully lived up to their promise and are comparable in size to toroids to be used in an induction linac.³

A.2.2 Insulators

Insulators represent another area where reduction in induction linac costs may be sought. At present, one can make insulators using alumina with brazed metal embedments, which work well but are expensive, or using epoxy or plastic materials which are less expensive, but are prone to tracking and have quite high outgassing rates.

At LBL we have begun a small program to examine filled plastic or epoxy insulators which would have the low outgassing of alumina and the low cost and ease of fabrication of plastic. One particularly attractive material is Polysil[®], a material developed for electrical use under the auspices of the U.S. Electric Power Research Institute.⁴ It consists of 85 percent by weight quartz sand and 15 percent polymethylmethacrylate (PMMA, or lucite). We have tested samples of this material in vacuum and it reliably holds 70 kV over a 25 mm path between plane stainless steel electrodes. Increasing the voltage causes no tracking after breakdown and no gas bursts. Fig 3 shows outgassing data we have recently taken on unbaked samples of Polysil[®]. The outgassing rate is already acceptable for some applications and can be reduced as shown after a vacuum bake at 140°C for 12 hours.

A.2.3 Modulator--Switches and Pulse Forming Network (PFN)

Table 1 shows a comparison of switch types which could be used in induction linacs at desirable repetition rates, i.e. approximately 10 Hz. The switches in the table are arranged in approximate decreasing order of peak power. The spark gap is the switch of choice for short pulse machines

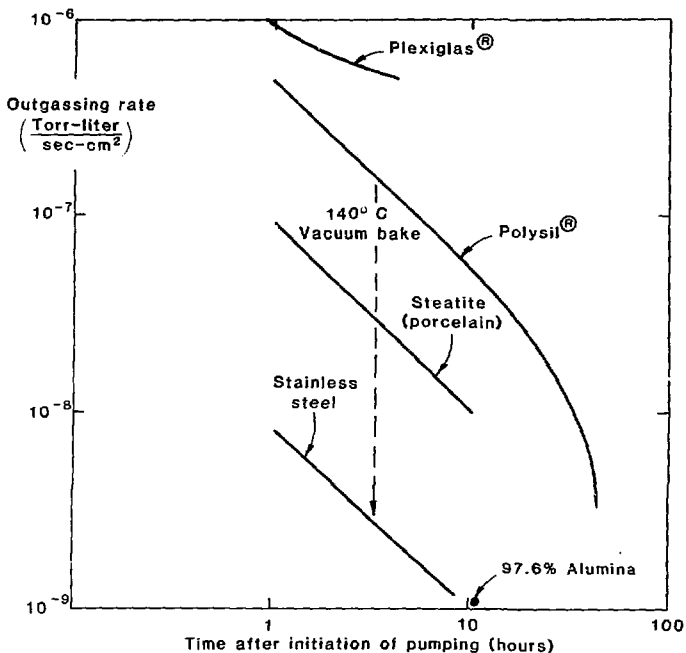

Outgassing Rates (mechanically cleaned, solvent cleaned, not vacuum baked)

XBL 823-8641

Fig. 3 Vacuum outgassing rates for Polysil[®] compared to other materials, unbaked, except that the vertical dashed line indicates the measured improvement for Polysil[®] upon vacuum baking.

Table 1 Representative Heavy Ion Fusion Driver Switch Characteristics

REPRESENTATIVE HEAVY ION FUSION DRIVER SWITCH CHARACTERISTICS

(REPETITION RATE > 10 Hz)

Type	Voltage	Current	Power	Cost	Recovery Time	Notes
Spark Gap	>30 kV	>30 kA	>10 ⁹ W	\$3K	> 3 ms	Lifetime limited by electrode erosion
Magnetic	> 30 kV	> 30 kA	>10 ⁹ W	>\$10K	0	Under development at LLNL, SNL, LANL
Thyratron	~ 30 kV	~ 5 kA	~10 ⁸ W	\$5K	~10 μsec	Faster recovery with clearing fields lifetime limited by gas cleanup, cathode
ignitron	~30 kV	~ 10 kA	~10 ⁸ W	\$1K	<1 ms	Under development at LBL/ Varian -National Electronics
Hard Tube	~ 30 kV	~ 1 kA	~10 ⁷ W	\$30K	0	Lifetime limited by cathode

using Blumlein pulse-forming lines because it can handle high peak power at high voltage, with a risetime of about 10 ns and a jitter of about 1 ns.

Magnetic "switches", based on the change in impedance of a ferromagnetic material, are at present under development at the Livermore, Los Alamos and Sandia laboratories. In turn, however, they also require a thyatron or other triggerable switch.

Because of the relatively higher cost and greater delicacy of thyatrons, a program at LBL in collaboration with National Electronics is investigating small ignitrons as switches for long pulse induction linacs. The principal goals are to reduce the jitter and risetime and retain long pulse life. Recent results on these special ignitrons show a risetime of ~ 50 ns and a jitter of ~10 ns, quite acceptable for HIF use at the low energy end of the machine.

A.2.4 Induction Linac Accelerators and Prototype Modules

Since electrons are usually relativistic when they emerge from the gun of an electron induction linac, there is no possibility of shortening the bunch by differential acceleration; consequently, the modules are all designed for a constant pulse duration. As a result, an induction linac for electrons consists of many identical modules following the gun. A whole class of accelerators, designed for pulse lengths of ~100 ns, used ferrite cores and Blumlein PFL's. The first accelerator of this type, the injector for the Electron Ring Accelerator (ERA) at Lawrence Berkeley Laboratory,⁵ is shown in Fig. 4. It had a beam voltage of 4 MeV, a current of 900A, a pulse width of 40 ns, a repetition rate of 5 Hz, and was designed as an injector for an experiment to investigate collective acceleration of ions by electrons. A direct descendent of ERA, the FXR at Lawrence Livermore National Laboratory, has just become fully operational.⁶ This accele-

rator, shown in Fig. 5, has a beam voltage of 20 MeV, a current of 4 kA, a pulse width of 60 ns, and a repetition rate of 1/3 Hz. It is designed as a high reliability source of intense bursts of x-radiation.

For ion induction linacs, however, one has very slowly moving particles in the early stages and bunching, with consequent current-amplification, is possible by tailoring the applied voltage waveforms. In order to avoid chromatic problems in the transport system one is constrained to accelerate the beam gradually. Because of the high space charge effects in these low velocity beams one is also required to extract a long pulse from the gun and initiate a gradual bunching process as the beam velocity increases. In short, one needs a gradation of pulse width for a multi-megajoule driver. This is shown in Fig. 6, where the required module pulse width is plotted against beam voltage for a particular 3 MJ driver scenario.¹ Representative parameters for a number of past or existing induction linac modules are shown along with the beam current in the machines and the year of construction. As one can see, most of the machines to date have had pulse lengths less than 500 ns.

The two exceptions are the NBS prototype at 2 μ s and the LBL prototype at 1.5 μ s. At the U.S. National Bureau of Standards in 1971 a research program was begun to reduce the costs of induction accelerators for longer pulses.⁷ One large module was constructed using 25 μ m-thick mild steel ribbon and containing nine cores. This module accelerated 1 kA of beam current in a 2 μ s pulse and added 400 keV energy to the beam.

At LBL we are building a 1.5 μ s, 250 kV module using 50 μ m thick Si_{0.03}Fe_{0.97} ribbon toroids. This will be described in more detail in Section 8.2. This device is similar to the modules which had been planned for previously proposed test beds⁸ and will add to our engineering experi-

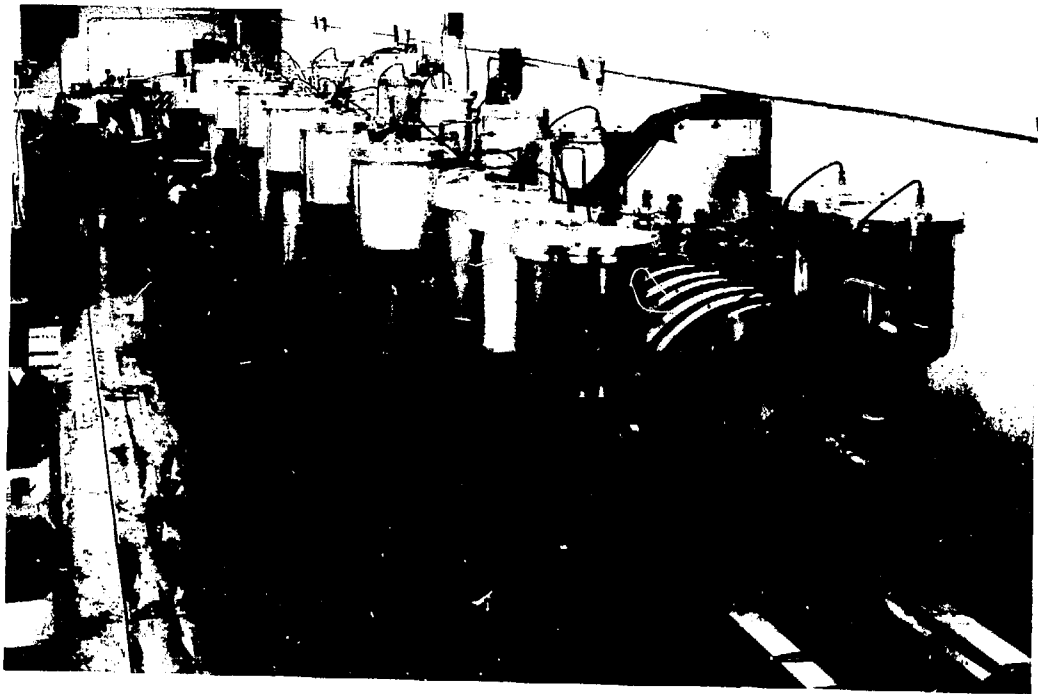
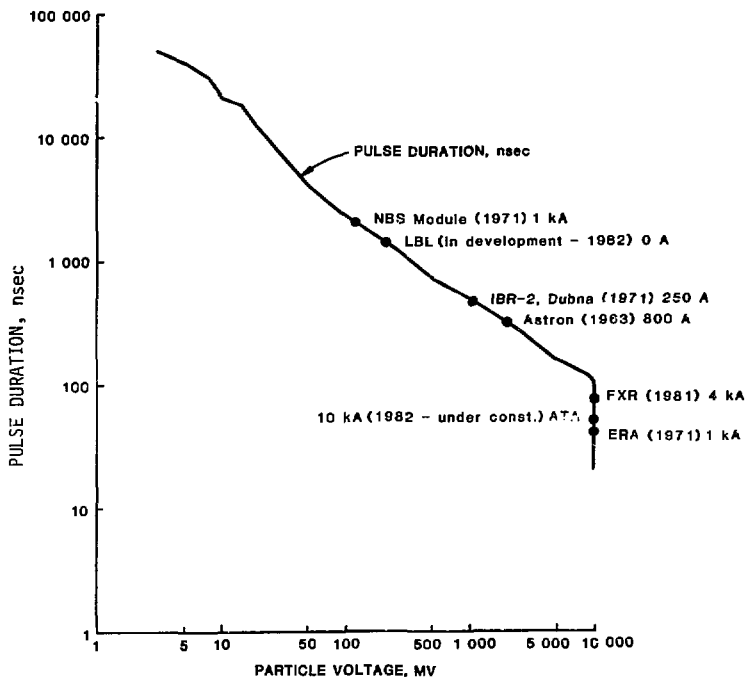

Fig. 4 The LBL Electron Ring Accelerator Injector (ERA), 1970.



XBB 822-1477

Fig. 5 The FXR Accelerator at LLNL, 1982.



XBL 823-8640

Fig. 6 Required pulse duration for 3MJ driver¹ with pulse duration and currents already achieved by induction linacs.

ence. This technology is, of course, applicable to all longer pulse durations as well.

B. Research Program at Lawrence Berkeley Laboratory

B.1. 2 MV Drift-Tube Linac

An induction-linac driver can benefit from an injector that delivers several amperes of ions with a kinetic energy of several MeV. To this end an early endeavor at LBL was the construction of a model injector, based on pulse power technology, in the 1 ampere, 2 MeV range.⁹ It operates at the space charge limit. Measurements of the beam optics and the emittance have provided encouragement that this pulsed drift tube design can be scaled up to greater current and high brightness. Alternative injector designs, e.g. a 3 MeV gun driven by a pulse transformer, may provide attractive alternatives. The drift-tube injector model has continued to provide a useful test facility for developing diagnostics for characterizing intense low-energy ion beams. The ions have ranges as short as one micron and hence can cause both damage and abundant electron production when they strike a material surface, which can shorten the lifetime of scintillators or lead to complications in interpreting beam-current measurements. Lampe¹ and Shiloh¹⁰ have developed an interesting non-destructive diagnostic in the form of a low energy electron beam directed at right angles to the ion beam in order to probe the transverse and longitudinal charge distribution of the ions.

B.2. Present Program.

Currently, the two major elements of the experimental program at LBL

comprise: a) fabrication of a long-pulse (1.5 μ sec) induction module, and b) a single beam transport experiment. Lack of funding has forced postponement of experiments on multiple-beam transport and acceleration. The long-pulse module will consist of 24 induction cores wound from 0.002 in. thick silicon steel tape (Fig. 7). A single lumped-element tapered pulse-forming network with an ignitron switch will drive two cores in parallel. Thus twelve pulsers are needed and, when separately controlled, will allow a variety of overall pulse shapes to be synthesized. At present, we are testing a prototype pulser driving a pair of cores.

The single-beam transport experiment will provide a test of the extensive analytical, computational and simulation predictions for the behavior of an intense beam in a long quadrupole transport channel. Knowledge of the magnitude of the space-charge limited current, and of any emittance modifications the beam may undergo under certain circumstances, is of considerable importance in designing and costing an ion induction linac. Space charge effects become important when the beam plasma frequency, $\omega_p = (4\pi nq_e/M_i)^{1/2}$, is no longer negligible compared to the betatron frequency. Figure 8 displays some predictions of the theory for three example cases that will be studied in the experiment. Here σ_0 denotes the single-particle betatron phase-advance per cell in the channel and σ the corresponding quantity in the space-charge dominated beam. For the case of $\sigma_0 = 60$ deg, the third-order instability is not expected to occur; also, numerical simulations done first by Hofmann¹¹ indicate that the instabilities that occur below $\sigma = 24^\circ$ result in a reordering of particles in phase-space but without any growth in the root-mean-square emittance. Not evident in Figure 8--since we chose to display the current density, j --are the explicit theoretical predictions concerning the effects of dif-

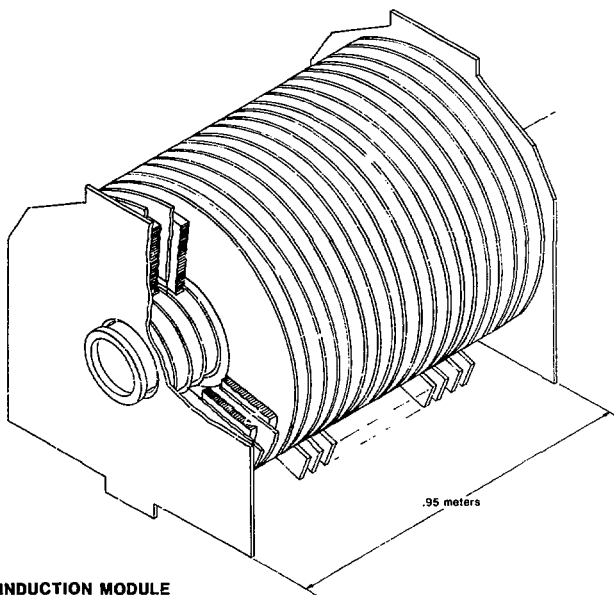

LONG PULSE INDUCTION MODULE

XBL 823 9639

Fig. 7 Long Pulse Induction Module prototype, LBL.

Unstable Transverse Modes For K-V Distribution (200 keV Cs⁺¹)

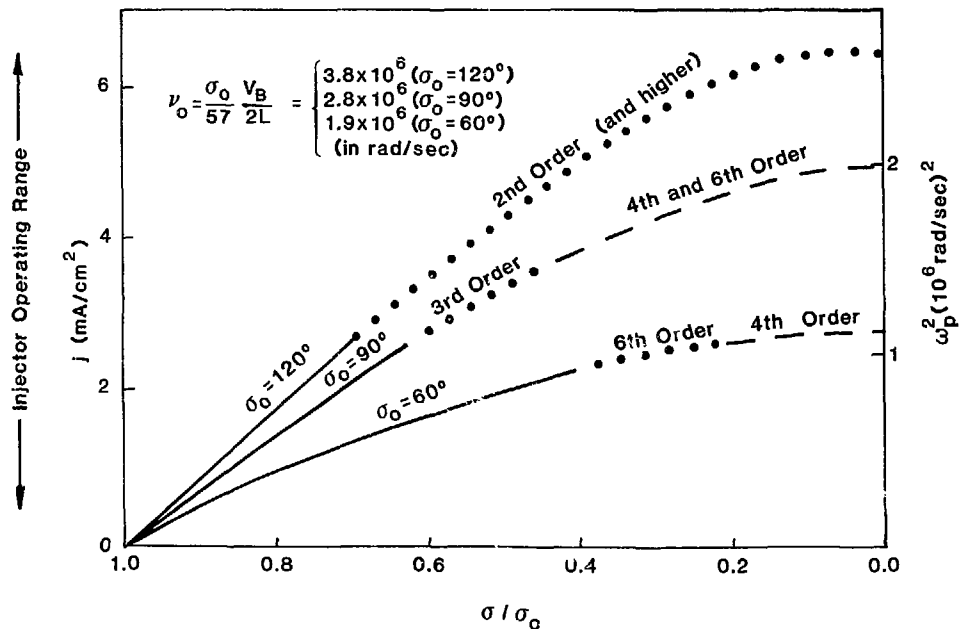

Fig. 8 Beam current density vs. space-charge depressed phase advance showing expected regions of instability. The definitions of the symbols and their interrelationships is given in the text.

XBL 825-9760

ferent beam emittances; the beam size, in fact, depends on both the current and the emittance.

The single beam transport experiment includes 82 quadrupole lenses that make up 41 periods of a FODO lattice. For reasons of economy it is an experiment scaled down in certain features but maintaining the essential physics of handling heavy ion beams and their associated problems in diagnostics and vacuum requirements. The ion chosen for the initial round of experiments is Cs^{+1} produced from a hot zeolite emitter,¹² but the scaling with ion mass will be studied later by substituting other zeolite sources, e.g. emitting sodium, calcium, potassium, rubidium, or thallium. The ion injector energy is chosen as 200 keV--an order of magnitude below the value desired for a fusion energy driver. Correspondingly scaled down is the current density--in the range 0 to 7 mA/cm².

The most crucial and painful compromise came, however, in electing to use electrostatic rather than magnetic quadrupole focusing for reasons of cost. This introduced two complications to the beam dynamics not to be encountered with a magnetically-focused beam in a smooth pipe. First, the kinetic energy of a beam particle is changed as it enters a lens, and it may be increased or decreased depending on whether it passes close to a negative or positive electrode. Second, the image forces lead to a strong octupole component because the beam cannot be screened from the four-fold symmetry of the electrodes by a metal pipe. Close, Herrmannsfeldt and Laslett¹³ have used a variety of computer tools to study these effects in detail and to set limits on experimental parameters (e.g. maximum beam size) within which their consequences can be ignored.

Figure 9 shows a diagram of the constant-voltage ion injector which contains four intermediate electrodes between the anode (~200 kV) and the

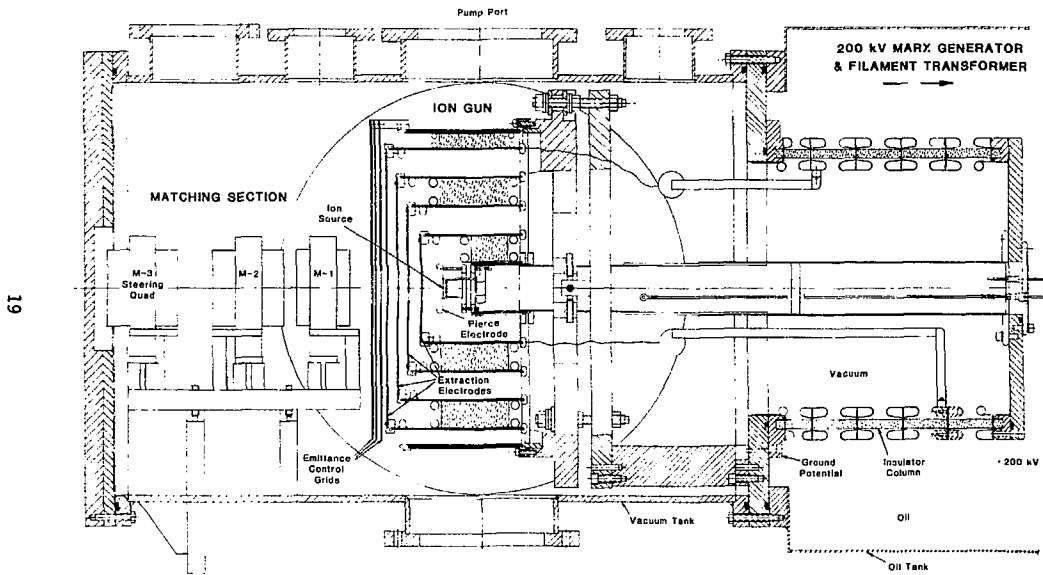

SINGLE BEAM TRANSPORT EXPERIMENT GUN & MATCHING SECTION

XBL 817-10883

Fig. 9 Single beam transport experiment injector showing Cs gun and first 3 electrostatic quadrupoles of matching section.

ground plane. The space-charge limited current is primarily controlled by varying the voltage on the first extraction electrode; the others are needed to maintain the beam optics close to laminar flow conditions.¹⁴ At the exit of the injector are placed three grids of thin wires. The first grid will be maintained at ground potential, the second at a voltage adjustable between 1 and 30 kV, and the third almost at ground potential (< 1 kV). The normalized emittance of the emerging beam varies approximately as the voltage of the second grid and can be varied up to 9×10^{-7} π meter-radians for the 200 keV Cs⁺¹ beam. Downstream of the injector are five matching quadrupoles to convert the axially symmetric beam into the properly astigmatic form characteristic of a matched beam in the long FODO transport channel. Calculations show that the injector optics should operate well over the range $j = 3-6$ mA/cm²; below this range overfocusing becomes troublesome. Accordingly a current attenuator made from a dense grid of wires will be introduced downstream from the emittance-control grids to allow exploration of the current density region $j = 0.5 - 3$ mA/cm².

The injector has now been operated for a few months. Space charge limited conditions have been verified and the dependence of beam size and current on the intermediate electrode settings found to be in good agreement with the calculations from the EGUN code^{14, 15} over the range $I = 18 - 30$ mA. Time-resolved emittance measurements at the bunch center, made with slits of various widths (0.2 - 1.0 mm), and a downstream scintillator, show that the normalized beam emittance (containing 95 percent of the particles in one phase-plane) in the absence of any grids is $\pi \epsilon_N = 5.5 \times 10^{-8}$ π radian-meters. This value is a few times the ideal "thermal" value derived from the beam size and the temperature of the emitting surface (~ 1000°C). The lateral extent and the tilt of the emittance ellipses yield values for

the beam size and divergence that are plotted in Fig. 10. Some systematic deviations from the computer calculations can be seen; these are not serious but do result in small corrections to the calculated matching quadrupole voltages.

B.3. High Temperature Experiment.

A long-term goal of the U.S. Accelerator National Plan¹⁶ is a high-temperature experiment (HTE) that would demonstrate energy deposition by generating a temperature of ~ 50 - 100 eV in a solid-density plasma. Clearly, the final physics and engineering design for the HTE will depend heavily on results from our present experimental program on transport, acceleration, and current amplification. The requirement of adequate specific energy (w , joules/gm) and, more especially, high irradiance (S , TW/cm^2), has pointed to the need for a multiplicity of high-current beamlets of low emittance, each independently focused to overlap on the target spot. The induction linac is unique among accelerator systems in offering the possibility of starting from the gun with exactly the number of beamlets required for the final focus, maintaining them independently-focused throughout the system, and achieving current-amplification at the same time. Since all the beamlets pass together through the same cores, they all will experience the same electric-field history; thus the beamlets will stay in synchronism even if the accelerating gap voltages stray somewhat from their exactly prescribed values. A strong advantage to keeping the number of beamlets a constant from gun to target is that beam manipulations such as the combining or splitting of beamlets can be avoided. Thus, this strategy provides a key to maintaining as low a beamlet emittance as possible, since either combining or splitting will always result in emittance dilution.

In order to keep costs at a minimum one must keep the HTE at as low a

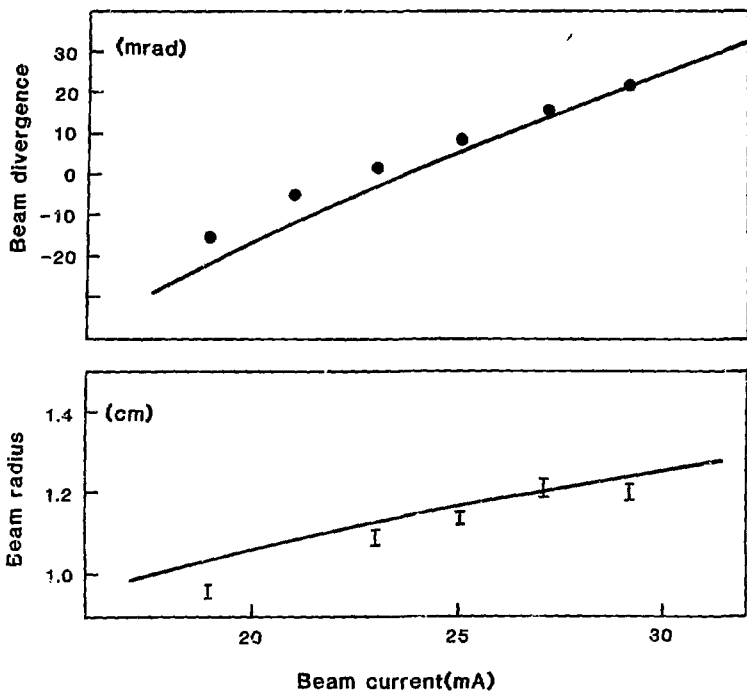

XBL 825-9761

Fig. 10 Single beam transport experiment gun output. Curves are calculated from known geometry and voltages, points are measured.

beam voltage as possible making it desirable to choose an intermediate-mass ion rather than the heaviest possible ion. Because of its nature, an induction linac can be readily adapted to accelerate whatever ion mass and charge state one chooses, simply by changing the timing of the modules.

As an example starting point for parametric studies, we consider the following parameters:

Ion:	Potassium ($A = 39$, $q = +1$)
Beam Energy:	2 kilojoules
Kinetic Energy:	100 MeV
Beam Charge:	20 microcoulombs (1.3×10^{14} ions/pulse)
Number of Beamlets:	64 (electrostatically focused)
Emittance/Beamlet:	2, 4, 10, $\times 10^{-7}$ rad meters (normalized)
Number of Modules:	~400
Max. Voltage/Module:	250 kV
Core Material:	2-mil silicon steel tape

For a more detailed discussion of this point design the reader is referred to a recent LBL Report.¹⁷

B.4. Theoretical Studies

Apart from the theoretical work in support of the driver design studies, such as beam capture and bunching, and of the single-beam transport experiment (quadrupole design, beam-dynamics), a major activity has been investigation of transverse and longitudinal stability and of transverse-longitudinal coupling. This work has been the subject of a recent well-referenced review paper by L. Smith.¹⁸

REFERENCES

1. A. Faltens, E. Hoyer, and D. Keefe; Proc. 4th International Topical Conference on High Power Electron and Ion Beam Research and Technology (Palaiseau, 1981), H. J. Doucet and J. M. Buzzi (Ecole Polytechnique, 1981) p. 751.
2. A. Faltens, D. Keefe, E. Hoyer and L. J. Laslett, IEEE Trans Nuc. Sci., NS-26, 3106 (1979).
3. D. Raskin and L. A. Davis, IEEE Spectrum, November 1981, p. 28.
4. J. E. Schroeder, Electric Power Research Institute Report EL-1093, May 1979.
5. R. Avery, G. Behrsing, W.W. Chuop, A. Faltens, E. C. Hartwig, H. P. Hernandez, C. McDonald, J. R. Meneghetti, R. C. Nemetz, W. Popenuck, W. Salsig, D. Vanecek, IEEE Trans. Nuc. Sci., NS-18, 479 (1971).
6. B. Kulke, D.S. Ravenscroft, G. E. Vogtlin, IEEE Trans Nuc. Sci., NS-28, 2882 (1981).
B. Kulke (private communication).
7. J. E. Leiss, M. J. Norris, M. A. Wilson, Particle Accelerators, 10, 223 (1980).
8. Heavy Ion Fusion Staff, Lawrence Berkeley Laboratory Report PUB-5031, Sept. 1979.
Heavy Ion Fusion Staff, Lawrence Berkeley Laboratory Report PUB-5039, Apr. 1980.
9. W. Chupp, A. Faltens, E. Hartwig, E. Hoyer, D. Keefe, C. Kim, M. Lampel, E. Lofgren, R. Nemetz, S. S. Rosenblum, J. Shiloh, M. Tiefenback, D. Vanecek. IEEE Trans Nuc Sci., NS-28, 3389 (1981).
10. J. Shiloh, M. Lampel, R. Sah, Bull Am. Phys. Soc. 26, 1007 (1981).
11. I. Hofmann, Nucl. Inst. and Methods, 187, 281 (1981).
12. J. P. Blewett and E. J. Jones, Phys. Rev. 50, 464 (1936).
13. E. Close and W. B. Herrmannsfeldt, IEEE Trans. Nuc. Sci., NS-28, 2425 (1981).
L. J. Laslett, Lawrence Berkeley Laboratory Report LBID-244, July 1980.
L. J. Laslett, Lawrence Berkeley Laboratory Internal Report HI-FAN-106, May 1980.
L. J. Laslett, Lawrence Berkeley Laboratory Internal Report HI-FAN-137, May 1980.
L. J. Laslett, Lawrence Berkeley Laboratory Internal Reports HI-FAN-150, 150A, March 1981.
14. C. Kim, Lawrence Berkeley Laboratory Internal Report, HI-FAN-160, 1981.
15. W. B. Herrmannsfeldt, Stanford Linear Accelerator Center Report, SLAC-226, November 1979.

16. R. O. Bangerter, *Compiler*, Los Alamos National Laboratory Preprint LA-UR-81-3730, Dec. 1981.
17. Heavy Ion Fusion Staff, Lawrence Berkeley Laboratory Report, PUB-5065 February, 1982.
18. L. Smith, Proc. 1981 Linear Accelerator Conference, Los Alamos National Laboratory Report, LA-9234-C, February, 1982, p. 111.