

FR8902783

# GANIL

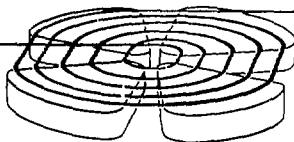

BEAM TUNING AND STABILIZATION  
USING BEAM PHASE MEASUREMENTS AT GANIL

A. CHABERT, F. LOYER, J. SAURET  
and Operation Group  
GRAND ACCELERATEUR NATIONAL D'IONS LOURDS  
BP 5027 14021 CAEN CEDEX (FRANCE)

GANIL. A84.08

# BEAM TUNING AND STABILIZATION USING BEAM PHASE MEASUREMENTS AT GANIL

A. CHABERT, F. LOYER, J. SAURET and Operation Group

GRAND ACCELERATEUR NATIONAL D'IONS Lourdes  
BP 5027 14021 CAEN CEDEX (France)

## SUMMARY

Owing to the great sensitivity of the beam phase to the various parameters, on line beam phase measurements proved to be a very efficient way of tuning and stabilizing the beam of the multi-accelerator complex. We recall the system which allows to obtain the different kinds of accurate measurements we need and describe the main applications :

- tuning process (buncher and SSC's RF phase determination, setting of the required radial beam phase law in the SSC's)
- stabilization of the beam by loops, the basic principle of which being to keep constant the beam central phase all along the machine by adjusting RF voltages or magnetic fields.

Feedback loops are described and comparative results with and without feedback are given.

## INTRODUCTION

GANIL is a cascade of 3 cyclotrons (Fig. 1) : a compact injector I1 followed by 2 separated sector cyclotrons SSC1 and SSC2 with a stripper in between. The beam transfer line L1 includes the buncher R1 ; in L2, the stripper is polarized at Vst.

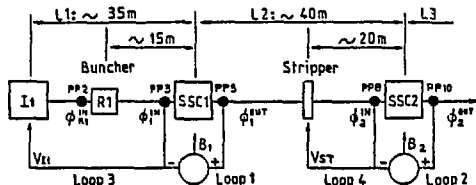

Fig. 1. Lay out of GANIL with the beam phase probes (PP) and the loops.

Among the essential aspects of the GANIL operation are first the tuning of the RF cavities (phase and voltage) and of the SSC radial field laws, second the stabilization of the beam obtained at the end of the tuning procedure. Measurements of beam central phases along the machine is one of the most powerful way to perform these two requirements.

### 1. BASIC PRINCIPLES FOR TUNING AND STABILIZATION

1.1 Radial phase law in a SSC. Adjusting the main field level and the trim coil currents we obtain a predetermined radial phase law :

$$\phi^{theo}(N) = \phi^{in} + \phi^0(N)$$

which can present various patterns (complete isochronism, phase compression ...). After being tuned (cf. §3) this phase law has to be maintained stable.

Beam stability is affected by variations of :

- the RF voltage V and phase  $\phi$  of the RF cavities.
- the radial phase law which depends on the stability of  $\phi^{in}$  (function of what has happened before the cyclotron) and on the law  $\phi^0(N)$  (related mainly to the stability of the field level).

Typical values are :

-  $\delta V/V < 10^{-4}$  which gives  $\delta W/W < 10^{-4}$  (sparking considerations excluded)

-  $\delta B/B$ , in fact  $\delta I/I < 10^{-5}$  (with slow variations much greater) and accounts for :

$$\delta\phi^0(N) = -2\pi h N \delta B/B \begin{cases} \approx 0.3^\circ \text{ in I1} & \Rightarrow \delta W/W = 1.5 \cdot 10^{-5} \\ \approx 1.7^\circ \text{ in SSC1} & \Rightarrow \delta W/W = 4.5 \cdot 10^{-5} \\ \approx 3.2^\circ \text{ in SSC2} & \Rightarrow \delta W/W = 1.6 \cdot 10^{-3} \end{cases}$$

In the SSC's, the  $\delta B$  effect is much greater than the  $\delta V$  one ; it is the opposite for I1. There from, the idea of locking the SSC mean field to the variations  $\delta(\phi^{out} - \phi^{in})$  of the difference between the input and output beam central phases in order to stabilize the phase law  $\phi^0(N)$  (loops 1 and 2, Fig. 1).

1.2 Phase stability in transfer lines. Variations of  $\phi^{in}$  depend on the variations of the energy and of the path of the central ion in the transfer line preceding a SSC :

$$\phi^{in} \propto k \left( 2 \frac{\delta L}{L} - \frac{\delta W}{W} \right) \begin{cases} k = 250^\circ/\text{m in L1 (modified by R1)} \\ k = 70^\circ/\text{m in L2} \\ k = 20^\circ/\text{m in L3} \end{cases}$$

Effects of the field stability in the transfer line dipoles is quite negligible.

Two ways of controlling  $\phi^{in}$  may be used :

- to lock the RF phases  $\phi$  of the cavities  $\Rightarrow$  the beam central phase  $\phi^{in}$ , this is possible due to the large energy acceptance of the SSC's. This method was previously applied but does not give very good results (possible divergence).
- to keep constant independently  $\phi$  and  $\phi^{in}$  against an external reference (the I1 RF phase) ; this means to keep energies constant.

In the GANIL RF cavities  $\phi$  is stabilized within  $0.1^\circ$  and we have then to stabilize  $\phi^{in}$ .

For SSC1 we chose to stabilize  $\phi^{in}$  by acting on the I1 RF voltage (loop 3, Fig. 1). It would have been possible to lock  $V_{I1}$  on  $\phi_{R1}^{in}$  measured in front of R1 ; in fact this loop was also tested and gave good results but it appears to be more global and convenient to use  $\phi_{I1}^{in}$ . Concerning SSC2, it would be possible to lock  $V_1$  on  $\phi_2^{in}$  but we have preferred to act on Vst. This is much easier and takes account in a global way of the  $\delta W$  variations at the SSC1 output as well as of those due to the stripper (loop 4, Fig. 1).

For the moment no attempt was made to stabilize  $\phi$  in L3, acting on the RF voltage V2, but such a loop is not excluded.

### 2. BEAM CENTRAL PHASE MEASUREMENT PROCESS

To achieve beam tuning and stabilization with the required accuracy, the following beam phase measurement process has been developed<sup>2,3</sup>.

2.1 Probe location. Beam phase measurements are performed :

- inside each SSC, using 15 pairs of capacitive probes, to tune the isochronism. These probes, loaded by 50 ohms, are located along a valley axis ; an extra UHF target, fixed on a movable radial yoke probe, allows the same phase measurements but turn by turn,
- along the beam lines, using 8 capacitive high impedance probes. In particular, 5 of them are used (Fig. 1) :
  - . at the SSC1 input (PP3) to tune the R1 buncher and SSC1 RF phases and to stabilize the beam phase at the SSC1 input ;
  - . at the SSC2 input (PP8) to tune the SSC2 RF phase



### 3. TUNING PROCEDURES

3.1. Buncher RF phase adjustment. The method is based on the fact that the central beam energy must not be affected when particles cross the buncher. So the beam line L1 is first tuned, the buncher being off, and the central beam phase is measured on PP3. Then the buncher is turned on at its nominal voltage and its RF phase is tuned until the beam phase becomes the same as previously.

3.2. SSC's RF phase determination. The method consists in reproducing the same phase shift between the beam and the SSC RF phases as those already obtained from a previous good tuning. A specific task measures the absolute phase between the beam on PP3 (or PP8) and the I1 RF using the method previously described to make an absolute measurement with calibration by measuring the beam phase on PP2. Then, using data obtained from a previous good tuning, the task computes the SSC1 (or SSC2) RF phase relative to the I1 RF.

The RF phase  $\phi$  determined by this method is accurate enough to inject the beam into the SSC and to adjust the isochronism. The fine tuning of  $\phi$  is done by observing the best turn separation near the extraction or better by minimizing the energy using the spectrometer located at the entrance of experimental areas.

3.3. Field corrections inside the SSC's. Using the beam central phases measured along the axis of a valley using the 15 pairs of capacitive probes, an interactive routine ISOGRO has been developed to automatically achieve the isochronism or any given beam phase law. The algorithm used to compute the field corrections and the user task diagram were previously described<sup>5,6</sup>. In this paper, we report the main improvements.

Using the precalculated values of the main and the trim-coil currents, the various beams are accelerated roughly to a radius of 2 meters. After one adjustment of the main coil current as computed by ISOGRO (about  $5 \cdot 10^{-4}$ ) these beams reach the extraction radius and a maximum deviation of  $\approx 20$  degrees of the beam phase from the contemplated one is then usually measured.

The field gradient correction procedure, based on a least square method, has been now tested for a wide range of energy and the isochronous field is reached within  $\pm 2$  degrees with only 2 or 3 iterations on the trim-coil currents. The isochronization procedure including beam phase measurements, calculations and power supply setting takes about 15 minutes. Figure 5 shows the results obtained in the case of an oxygen beam accelerated in SSC2 at the energy of 95 MeV/A, which corresponds to our maximum  $\gamma$ .

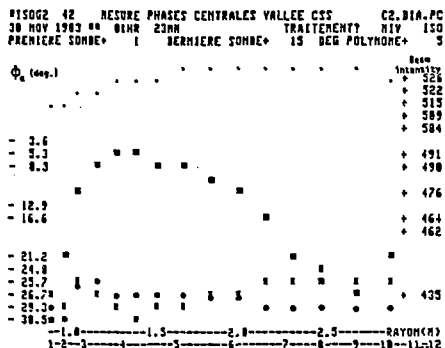

Fig. 5. Beam central phases measured during the isochronization process : 95 MeV/A oxygen beam in SSC2 :  
 • with precalculated trim-coil currents  
 □ after one iteration on trim-coil currents  
 △ after two iterations on trim-coil currents

The whole procedure has to be done only once for each case (ion or energy) and the final trim-coil currents obtained ensure a good reproducibility of the magnetic field for another run using the same beam. The computer code is used in operation to adjust the main current within an accuracy better than  $10^{-5}$ . As the beam phase device is not destructive it is also often used to survey the stability of the magnetic field.

The on-line code ISOGRO can fit any phase law introduced in data. Figure 6 gives an example of an improved experimental phase law in SSC1 used to provide bunch length compression and output energy insensitive to small field level variations<sup>6</sup>.

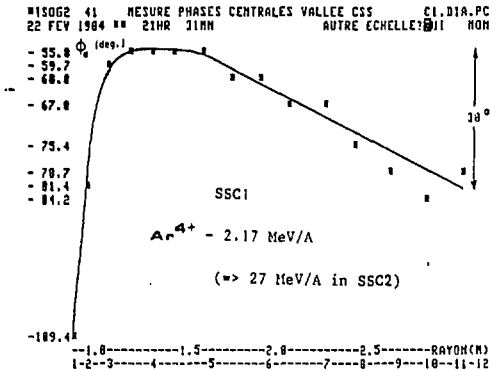

Fig. 6. Beam phase law in SSC1 for phase compression.

### 4. BEAM PHASE STABILIZATION DEVICE

4.1. Functional description. The 4 beam phase stabilization devices are those presented previously (Fig. 1).

Figure 7 shows as an example the typical block-diagram of loop 1 and 3 devices made in the following way :

- the phase probes and their phasemeter units (Fig. 2) give the beam phase variation signal  $\delta\phi$ , the beam intensity X and its status in the relative measurement mode.
- the signal processing unit (Fig. 7b) transmits  $\delta\phi$  from the phasemeter to the control unit when the beam and the phasemeter are correct :  $\delta\phi_p = \delta\phi$ . When the beam behaviour becomes unusual (intensity too low or too high), this unit sends to the control unit the memorize phase signal detected before (Fig. 8). If the beam behaviour keeps bad too long, the unit makes  $\delta\phi_p = 0$  or informs the control unit by the signal  $\bar{O}K$ . At present, the waiting time  $\tau$  is 10 s long but it can be stretched up to a few hours if necessary.
- the control unit (Fig. 7c) establishes the loop with the required transfer function. The loop gain is about 10, thus the beam phase shift is divided by 10. The bandwidth is 10 Hz and will be possibly increased for loop 3 and 4 only, loop 1 and 2 bandwidths being limited by the magnetic field response.

Procedure for users is the following :

- phasemeters operating in relative measurement mode
- loop tuning with the help of a zero detector to get a null correction (SC = 0) and loop switching on
- if the correction signal SC is too high, a level alarm requests the operator (and later the computer as a future development) for a better tuning of either the SSC magnetic fields for loops 1 and 2, or the injector RF voltage for loop 3, or the SSC1 RF voltage for loop 4 in order to get approximately a zero correction signal (SC = 0)
- if  $\bar{O}K$  becomes on, the loop is automatically set off

and the correction signal is null ( $SC = 0$ )  
 - when the beam failure disappears, the operator can set on the loop again with the previous beam tuning or with a new one.

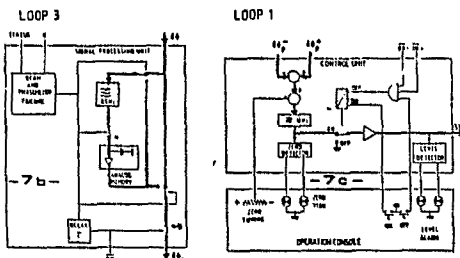
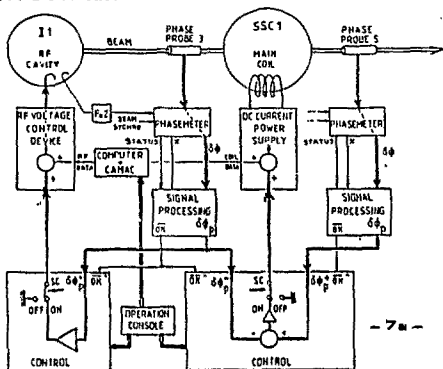

Fig. 7. a) loop 1 and 3 devices block-diagram  
 b) signal processing unit  
 c) control unit

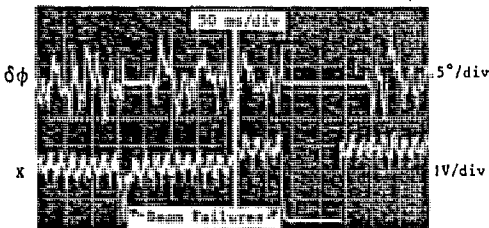

Fig. 8. Two examples of  $\delta\phi_p = \delta\phi$  memorized during a beam failure.

4.2. Performances in operation. Loops 1 and 3 have worked for a few months and Loop 4 has just been turned on.

In operation, these beam phase stabilization systems have two functions :

- first, they make monitoring more comfortable. Without stabilization, one has to watch the beam phases continuously and to retune the parameters as soon as a beam phase shifts too much ( $\approx 1^\circ$ ) in order to keep a constant beam. This is particularly important during the early days of a run (for instance, SSC magnetic fields may shift up to  $5 \cdot 10^{-3}$  during the first two days). With stabilizations, operators have to act only when a level alarm requests them ; otherwise the beam is always correct. Fig. 9 shows an example of beam phase without stabilization (it has been necessary to retune  $V_{11}$ ) and with stabilization (loops 1, 3, 4 only).
- second, they allow to keep optimal beam characteristics and especially beam central energy.

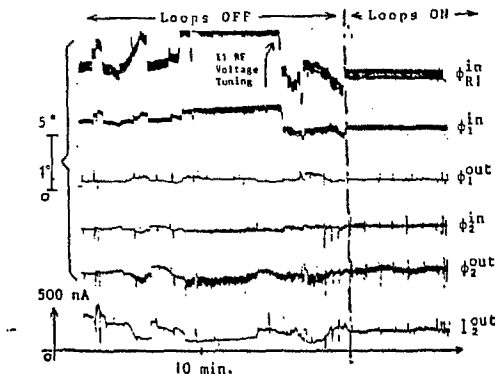

Fig. 9. Effects of beam phase stabilization.

### CONCLUSION

The phase lock system developed for the GANIL multiaccelerator complex keeps constant central beam phases, i.e. energies, hence the ion path. Beam characteristics on targets are then well defined and stable.

The strong dependence of phase on machine parameters makes this method very accurate. Machine parameters chosen for control prove to be very efficient, considering the results, although they are not always exclusively responsible for the phase shifts. More experience and studies would be necessary for a still better understanding and control of the beam, in particular on the point of view of the reproducibility of the initial settings. In principle, beam central phase values, all along the machine must be the same for the whole range of particles accelerated in GANIL with a given set of harmonics.

### References

1. A. Joubert et al., "Main Results on the RF Amplitude and Phase Regulation System in Operation at GANIL, this conf.
2. F. Loyer et al., "Main Beam Diagnostics at GANIL", Proc. of the 9<sup>th</sup> Int. Conf. on the Cycl. and their Appl., CAEN (France), Sept. 1981.
3. J.M. Loyant et al., "The Computerized Beam Phase Measurement System at GANIL", Proc. of the Conf. "Computing in Accelerator Design and Operation", West-Berlin, 1983, to be published.
4. M. Promé et al. "The operation of the GANIL control System", this Conf.
5. J. Sauret et al., "Magnetic field Setting and Automatic Isochronization in the GANIL SSC's", Proc of the 8<sup>th</sup> All. Union Conf. on Charged Part. Accel. Tome 1, Protrvino, USSR, Oct. 1982.
6. A. Joubert et al., "Status Report on the GANIL Facility", This Conf.