

~~TOP SECRET~~
JINR - E -- 2 - 88 - 655



**ЛЕКЦИИ
ДЛЯ МОЛОДЫХ
УЧЕНЫХ**

Jan Ambjørn

**Non-Perturbative
Field Theory / Field Theory
on a Lattice**

ДУБНА

ЛЕКЦИИ ДЛЯ МОЛОДЫХ УЧЕНЫХ

Выпуск 49

РЕДАКЦИОННЫЙ СОВЕТ

А.Н.Сисакян — председатель
А.Т.Филиппов — зам. председателя
Г.М.Гавриленко — ученый секретарь
В.Б.Беляев
Б.В.Васильев
В.П.Гердт
В.А.Загребнов
Г.В.Мицельмахер
В.А.Никитин
В.Р.Саранцева
Д.В.Ширков

JOINT INSTITUTE FOR NUCLEAR RESEARCH

JINR - E2-88-655 .

Jan Ambjørn*

**NON-PERTURBATIVE
FIELD THEORY / FIELD THEORY
ON A LATTICE**

Dubna 1988

* The Niels Bohr Institute, University of Copenhagen
Blegdamsvej 17, DK-2100 Copenhagen Ø, Denmark

C O N T E N T S

1. Introduction.	3
2. Field Theories are Nothing But Classical Spin Systems Near Their Critical Points.	3
3. The Renormalization Group and Critical Phenomena.	10
4. The Approach to a Critical Point / the Continuum Limit.	15
4.1. The Gaussian Fixed Point.	15
4.2. Marginal Operators at the Gaussian Fixed Point: Triviality Versus Asymptotic Freedom.	18
4.3. The β -Function.	19
4.4. Critical Exponents Near a Fixed Point.	21
4.5. MCRG Transformation: an Explicit Example.	23
5. The Continuum Limit for Non-Abelian Lattice Gauge Theories.	25
5.1. The Lattice Action.	25
5.2. The String Tension and Other Observables in Lattice QCD.	27
5.3. The String Tension in Three Dimensions and String Dynamics.	32
5.4. Limitations of MC and the Quest for Intelligent Important Sampling.	38
6. Conclusion.	40
References.	40

1. INTRODUCTION

Although QCD, quantum chromodynamics, has now been around for more than 14 years, it is a sad fact that no reliable non-perturbative, analytical methods of doing calculations have been developed. There is no question that QCD is a very successful short distance, perturbative theory. However, although it has the potential of describing the "long distance" hadronic properties of matter, we do not yet know whether it does or not. The lack of reliable schemes for calculating, for instance, the hadron masses have prevented us from testing this aspect of the theory.

This regrettable situation led to the brute force approach, known as Monte Carlo lattice methods. One simply puts the whole world on a lattice, defines a discretized version of the continuum action and on a large, but finite, lattice lets the computer do the high dimensional functional integral by means of Monte Carlo techniques for importance sampling over field configurations. This approach has again brought into focus the deep connection between the theory of critical phenomena in statistical mechanics and the renormalization of field theories.

In the following we will briefly outline this connection, describe how we can use it to obtain information about non-perturbation quantities in QCD, and also mention the quest for more intelligent ways of doing the Monte Carlo simulations.

2. FIELD THEORIES ARE NOTHING BUT CLASSICAL SPIN SYSTEMS NEAR THEIR CRITICAL POINTS

In the following we will always assume that we have performed a rotation where time t goes to $-i\tau$. We are working in Euclidean space, not Minkowski space. Appealing to general theorems by Osterwalder and Schrader this is always possible.

The Lagrangian for a scalar field will be

$$\mathcal{L}(\phi) = \frac{1}{2} (\partial_\mu \phi)^2 + V(\phi) \quad (2.1)$$

and partition functions (the generating functional for Green functions (or correlation functions)) can be written:

$$\begin{aligned} Z(\mathcal{J}) &= \int \mathcal{D}\phi \, e^{-S(\phi, \mathcal{J})} \\ &= \int \mathcal{D}\phi \, e^{-\int d^d x (\mathcal{L}(\phi) + \phi \mathcal{J})}. \end{aligned} \quad (2.2)$$

The measure " $\mathcal{D}\phi$ " is the Feynman path integral measure and is ill defined as it stands in eq. (2.2):

$$\mathcal{D}\phi = \prod_{x \in \mathbb{R}^d} d\phi(x). \quad (2.3)$$

A natural way to make sense of it is to discretize Euclidean spacetime \mathbb{R}^d , for instance, by imposing a hyper-cubic lattice structure:

$$\begin{aligned} x &\rightarrow x_n \equiv a n_\mu \hat{e}_\mu \\ \phi(x) &\rightarrow \phi_n \equiv \phi(x_n) \\ \mathcal{D}\phi &\rightarrow \prod_n d\phi_n \\ \partial_\mu \phi &\rightarrow \frac{1}{a} (\phi(x_n + \hat{e}_\mu) - \phi(x_n)) \equiv \frac{1}{a} (\phi_{n+\hat{\mu}} - \phi_n) \quad (2.4) \\ S(\phi, \mathcal{J}) &= \int d^d x \frac{1}{2} ((\partial_\mu \phi)^2 + V(\phi) + \mathcal{J}\phi) \rightarrow \\ &\sum_n a^d \left\{ \frac{1}{2a^2} \sum_\mu (\phi_{n+\hat{\mu}} - \phi_n)^2 + V(\phi_n) + \mathcal{J}_n \phi_n \right\}. \end{aligned}$$

In these formula \hat{e}_μ denotes d orthonormal unit vectors and "a" the lattice spacing. If one takes a finite volume V of spacetime

$\mathcal{Z}[\Phi]$ is then converted into a finite dimensional integral $\prod_n^V d\phi_n$ and one can study the limit $V \rightarrow \infty$.

One ugly aspect of such a regularization of the path integral is that Poincaré invariance (Euclidean invariance) is broken. On the other hand, we have obtained a strict control over the short distance singularities of the theory, since we have a UV-cut off $\Lambda = \pi/a$. Furthermore it turns out that internal symmetries, even local ones, can usually be preserved in a natural way. This is of course especially important if we want to address gauge theories.

As an example we consider a ϕ^4 theory in $d=4$ dimensions:

$$\mathcal{L}(\phi) = \frac{1}{2} (\partial\phi)^2 + \frac{1}{2} m^2 \phi^2 + \frac{1}{4} g^2 \phi^4. \quad (2.5)$$

By scaling the fields and sources:

$$\phi' = \sqrt{g} a^{d/2-1} \phi \quad ; \quad J' = \frac{1}{\sqrt{g}} a^{d/2+1} J \quad (2.6)$$

the partition function (2.2) may be written:

$$\mathcal{Z}(J'; g) = \prod_n^V a^{-(d/2-1)} \int \prod_n^V d\phi'_n \exp\left(-\frac{1}{g^2} S(\phi', J')\right) \quad (2.7)$$

$$S(\phi', J') = \sum_n \frac{1}{2} \sum_{n'} (\phi'_{nn'} - \phi'_{n'})^2 + \frac{1}{2} m^2 a^4 \phi_n'^2 + \phi_n'^4 + J_n' \phi_n'$$

The free energy (the generating functional of connected Green functions) of the system, $F(J)$, is defined by:

$$\mathcal{Z}(J) = e^{-F(J)} \quad (2.8)$$

and the constant in front of the integral in (2.7) only contributes an additive constant proportional to the volume of $F(J)$, but with no reference to the dynamics. It can be dropped.

We can view (2.7) as the partition function of classical spin system. Indeed an effective, classical theory of spin-spin coupling in a ferromagnet would have the following Hamiltonian:

$$H(S, h) = - \sum_{n,m} V_{n,m} S_n \cdot S_m + h \cdot \sum_n S_n \quad (2.9)$$

and partition function

$$Z(h, \beta) = \int \prod_n dS_n \varrho(S_n) e^{-\beta H(S, h)} \quad (2.10)$$

In (2.9) $V_{n,m}$ is the coupling of spins at sites n and m in the lattice. If we assume the lattice is hyper-cubic and we only have the nearest neighbour interactions, we can write

$$- \sum_{n,m} V_{n,m} S_n \cdot S_m = k \cdot \sum_n \left(\sum_r (S_{nr} - S_n)^2 - 2d S_n^2 \right). \quad (2.11)$$

In (2.10) $\beta = 1/kT$ and $\varrho(S_n)$ is a weight factor describing the local properties of the spin. A choice like

$$\varrho(S_n) = \exp(-(\kappa S_n^2 + \lambda S_n^4)) \quad (2.12)$$

gives a convenient effective description. The partition function may now be written as:

$$Z(\kappa, \mu, \lambda, h) = \int \prod_n dS_n e^{-H(S; \kappa, \mu, \lambda, h)}$$

$$H(S; \kappa, \mu, \lambda, h) = \sum_n \left(\kappa \sum_r (S_{nr} - S_n)^2 + \mu(\lambda) S_n^2 + \lambda(\beta) S_n^4 + h S_n \right). \quad (2.13)$$

The Ginzburg-Landau theory of ferromagnetic transitions assumes that $\kappa(\beta)$, $\mu(\beta)$ and $\lambda(\beta)$ are smooth functions of the temperature since they depend only on local properties. The ferromagnetic transition occurs when $\mu(\beta_c) = 0$. The value of T , where $\mu(\beta_c) = 0$, is called the critical temperature T_c . Minimizing the effective Hamiltonian in (2.13) we get a ground state where all $S_n = 0$ if $\mu > 0$ (see fig. 1a):

$$\langle S \rangle \equiv \frac{1}{V} \sum_n S_n = 0 \quad \text{for } \mu(\beta) > 0 \quad (2.14)$$

while the ground state for $\mu(\beta) < 0$ corresponds to all S_n aligned with $S_n = \sqrt{\frac{-\mu}{2\lambda}}$ (see fig. 1b):

$$\langle S \rangle \equiv \frac{1}{V} \sum_n S_n = \sqrt{\frac{-\mu}{2\lambda}} \quad \text{for } \mu(\beta) < 0. \quad (2.15)$$

As we assume $\mu(\beta)$ is a smooth function near β_c we might write:

$$\mu(\beta) \approx c_0(\beta - \beta_c) \quad \text{for } \beta \approx \beta_c \quad (2.16)$$

and we get:

$$\langle S \rangle \sim \sqrt{\beta - \beta_c} \quad \text{for } \beta > \beta_c. \quad (2.17)$$

This shows the typical non-analytic behaviour at points of phase transitions.

If we compare our partition function for the scalar field (eq. (2.7)) with the one for our spin system (eq. (2.13)) we see that the continuum limit of our regularized field theory ($a \rightarrow 0$) corresponds to approaching the critical point of the ferromagnetic transition ($\mu(\beta) \rightarrow 0$) because of the identification

$$m^2 a^2 \sim \mu(\beta). \quad (2.18)$$

It is therefore not surprising that all the machinery and intuition available from the theory of critical phenomena can be taken over to field theory. Let us briefly summarize the notations used: near the critical point the following observables are of interest (among others):

$$M(h, \beta) = \frac{1}{V} \sum_n \langle S_n \rangle \quad (\text{magnetization})$$

$$\chi(h, \beta) = \frac{\partial M}{\partial h} \quad (\text{susceptibility})$$

$$= \frac{1}{V} \sum_{n,m} \langle (S_n - M)(S_m - M) \rangle$$

$$\langle (S_n - M)(S_m - M) \rangle \sim e^{-|X_n - X_m|/\xi(h, \beta)}$$

$$\xi(h, \beta) \ll |X_n - X_m| \quad (\text{correlation length})$$

$$\langle (S_n - M)(S_m - M) \rangle \sim |X_n - X_m|^{-(d-2+\epsilon)}$$

$$a \ll |X_n - X_m| \ll \xi(h, \beta) \quad (\text{anomalous dimension}).$$

(2.19)

The behaviour of these quantities is obviously governed by the spin-fluctuations and the correlation length ξ is of crucial importance. The hypothesis that all singular behaviour near the phase transition is due to the divergence of the correlation length ξ is called a scaling hypothesis. In the Gaussian approximation, where we only include quadratic fluctuation around the minimum (2.14) or (2.15) in our functional integral, it is easily seen that

$$\xi(h, \beta) \sim 1/\sqrt{|\mu(h, \beta)|} \quad (2.20)$$

and indeed diverge near the critical point.

The singular behaviour leads to the definition of critical exponents, characterizing it:

$$\chi(\beta) \sim |\beta - \beta_c|^{-\gamma}$$

$$\xi(\beta) \sim |\beta - \beta_c|^{-\nu}$$

(2.21)

and by using the assumption that the behaviour of the correlation function is governed by only one divergent parameter near the critical point it is straightforward to prove

$$\gamma = \nu(2 - \epsilon) \quad (\text{Fischer's scaling relation}). \quad (2.22)$$

It should be stressed that these exponents are not just mathematical definitions. One can measure γ , ν and ϵ in materials like Fe, Ni, γFeO_3 , Gd, etc., using neutron diffraction and other experimental techniques.

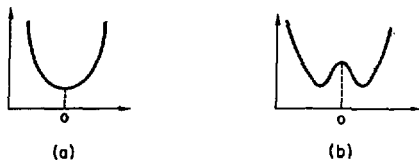

Fig. 1.

Potential $\mu(\beta)S^2 + \lambda(\beta)S^4$ for
 (a) $\mu(\beta) > 0$ and (b): $\mu(\beta) < 0$

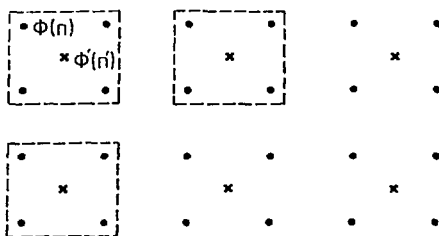

Fig. 2.

A Kadanoff blocking for $S=2$ on a cubic lattice

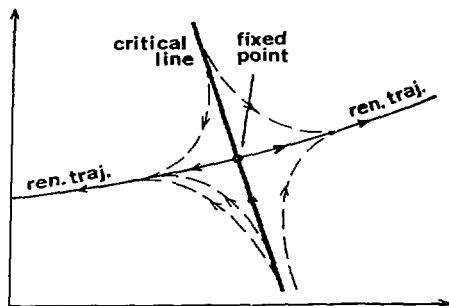

Fig. 3.

RG-flow in the neighbourhood of a fixed point
 The critical surface is usually multi-dimensional

The remarkable fact is that they come out universal even if the materials mentioned of course have different $\mathcal{G}(S_n)$ and $\sum_{n,m} v_{n,m}$ $\cdot S_n S_m$ and vastly different T_c . Since they are connected with divergent correlation length ξ we see that long range phenomena near the critical points show universality.

For field theory it translates into the statement that the details of how we regularize the theory at lattice distances are to a great extent irrelevant for the continuum limit. Only few parameters are relevant and these determine the continuum limit. Different possibilities of continuum limits are labelled by different critical exponents and are said to belong to different universality classes.

In field theory it becomes of major importance to understand which universality classes can exist and the basic tool for understanding the whole concept of universality is the renormalization group equations (RGE). Today it has been combined with Monte Carlo techniques for simulating these theories (MCRG). It is fair to say that MC-techniques are the only general methods available if we want to explore non-perturbative aspects of field theory for dimensions $d > 2$.

3. THE RENORMALIZATION GROUP AND CRITICAL PHENOMENA

The renormalization group approach to critical phenomena is the simplest way to understand universality. From now we will drop the distinction between spins and fields and our toy model Hamiltonian will be

$$H = \sum_n \sum_r (\phi_{n+r} - \phi_n)^2 + \mu \phi_n^2 + \lambda \phi_n^4. \quad (3.1)$$

By a Kadanoff transformation we divide our original lattice in blocks of size s^d , where s is an integer, and define an average field in the block labelled n' (see fig. 2):

$$\phi'_{n'} = s^{-d} \sum_{n \in B_s(n')} \phi_n. \quad (3.2)$$

The distribution of $\phi'_{n'}$ can be determined from the one of ϕ_n :

$$e^{-H'[\phi'_n]} = \int \prod_n d\phi_n e^{-H[\phi]} \prod_{n'} \delta(\phi'_{n'} - S^{-d} \sum_{n \in B_s(n')} \phi_n). \quad (3.3)$$

We end by scaling the blocks back to the original size:

$$\begin{aligned} X_s &\equiv X/S \\ \phi_s &\equiv S^{-\alpha} \phi' \quad ; \quad \alpha = \frac{1}{2}(d-2+\epsilon) \\ H_s(\phi_s(x_s)) &\equiv H'(\phi'(x')). \end{aligned} \quad (3.4)$$

If we measure the correlation length ξ in lattice units it has been decreased by S :

$$\xi_s = \xi/S. \quad (3.5)$$

The factor $S^{-\alpha}$ might not be very intuitive, but recall that near the critical point the correlation length ξ diverges, the theory has "almost" massless excitations, and the correlation function will have a power fall off (2.19):

$$\begin{aligned} \langle \phi_n \phi_0 \rangle &\sim 1/n^{d-2+\epsilon} \quad , \\ 1 &\ll n \ll \xi. \end{aligned} \quad (3.6)$$

Consider now the block transformation (3.2):

$$\begin{aligned} \langle \phi'_{n'} \phi'_{0'} \rangle &= \left\langle S^{-d} \sum_{n \in B_s(n')} \phi_n \cdot S^{-d} \sum_{n \in B_s(0')} \phi_n \right\rangle \\ &\approx \langle \phi_{3n'} \phi_0 \rangle \end{aligned} \quad (3.7)$$

since all the S^{2d} correlation functions are at essentially the same distance if n' is very large.

From (3.6) we therefore see that the short distance (still large compared to lattice) properties of correlation functions are left unchanged by blocking only if we scale ϕ' by $S^{-\alpha}$, $\alpha = \frac{1}{2}(d-2+\epsilon)$.

The form of $H_s(\phi_s)$ is not identical to the one of $H(\phi)$ in eq. (3.1) which was the starting point. Other terms like

$$(\phi_{n+\mu} - \phi_n)^2 \phi_n^2, (\phi_{n+\mu} - 2\phi_n + \phi_{n-\mu})^2 \quad (3.8)$$

will be generated. As we want to repeat the Kadanoff blocking it is therefore natural to start with a completely general action:

$$H[\Phi] = \sum_{\alpha} K_{\alpha} S_{\alpha}(\Phi). \quad (3.9)$$

where S_{α} ($\alpha = 1, 2, \dots$) are different actions which should conform with the original symmetries of the action and lattice. It is important, as will be discussed later, especially for gauge symmetries. The couplings K_{α} now take values in a multidimensional (in principle infinite-dimensional) coupling constant space, and successive blockings can be viewed as a mapping of this space onto itself, called the renormalization group (RG) transformation

$$RG: \{K_{\alpha}\} \rightarrow \{RG(K_{\alpha})\}. \quad (3.10)$$

The function RG might have certain fixed points K_{α}^* . For such a fixed point we have

$$RG(K_{\alpha}^*) = K_{\alpha}^* \quad \forall \alpha \quad (3.11)$$

and it follows from eq. (3.5) that the correlation length must be infinite (or zero) for this choice of coupling constants. The fluctuations extend over all scales of the lattice and the system has become critical.

To each fixed point K_{α}^* we can associate a critical surface, namely the points K_{α} which are attracted by the fixed point K_{α}^* :

$$(RG)^n(K_{\alpha}) \xrightarrow{n \rightarrow \infty} K_{\alpha}^*. \quad (3.12)$$

The important point of the blocking is that we perform a coarse graining of the system. By taking the average over blocks we ignore short distance details, but keep long range phenomena intact, provided the correlation length ξ is much larger than the block size.

Every point on the critical surface corresponding to K_{α}^* has of course infinite ξ (since blocking reduces correlation length and the fixed point to which the point converge also has $\xi = \infty$) and the long distance physics for any point on the critical surface is therefore expected to be identical to the long distance physics determined by K_{α}^* .

The fundamental hypothesis connecting RGE to critical phenomena is that the couplings of the material in question (Fe, Ni, etc.):

$$K_\alpha(\beta) = (K(\beta), \mu(\beta), \lambda(\beta), \dots) \quad (3.13)$$

belong to a critical surface when $\beta = \beta_c$ ($T = T_c$).

If we now assume (it will be justified in the next section) that (1): critical surfaces are expected to be large subspaces of the total space $\{K_\alpha\}$ and that (2): the critical exponents are determined by the RGE near the critical point we can understand universality: many different materials "i" at their critical points $\beta_c^{(i)}$ can be represented by vastly different points $K_\alpha^{(i)}$ ($\beta^{(i)}$) in coupling constant space, but they will belong to the same critical surface (β): same fixed point K_α^*) when $\beta^{(i)} \rightarrow \beta_c^{(i)}$.

Suppose that a point K_α is near a fixed point K_α^* :

$$K_\alpha = K_\alpha^* + \delta K_\alpha \quad (3.14)$$

$$RG(K_\alpha) = K_\alpha^* + \sum_{\alpha'} T_{\alpha\alpha'} \delta K_{\alpha'} + O((\delta K)^2).$$

If we expand δK_α in eigenvectors of the linear operator $T_{\alpha\alpha'}$:

$$\delta K_\alpha = \sum_a h_a U_{a\alpha} \quad (3.15)$$

$$\sum_{\alpha'} T_{\alpha\alpha'} U_{a\alpha'} = \lambda_a U_{a\alpha}$$

the action (3.9) can be written:

$$H[\phi] = H^*[\phi] + \sum_a c_a U^a[\phi]$$

$$H^*[\phi] = \sum_\alpha K_\alpha^* S_\alpha[\phi] \quad (3.16)$$

$$U_a[\phi] = \sum_\alpha U_{a\alpha} S_\alpha[\phi].$$

Repeated application of the RG will give:

$$H[\phi] \rightarrow H^*[\phi] + \sum_a \lambda_a^n c_a U^a[\phi]. \quad (3.17)$$

The interactions which have $\lambda^a < 1$ are suppressed after a few RG steps. They are called irrelevant. The interactions with $\lambda^a > 1$ are called relevant and they will eventually take one away from the critical point provided the decomposition of δK_α contains these components. Finally the interactions with $\lambda^a = 1$ are called marginal. Whether they will contribute or not can only be decided by considering higher order corrections to the linearized RG transformation given by $T_{\alpha\beta}$.

It is now seen that the critical surface in the neighbourhood of K_{α}^* is spanned by the irrelevant operators $V^a(\phi)$.

If we are close to the critical surface, but not exactly on the surface, the coefficients h_a for the relevant operators must be small. If we block we will first move towards the fixed point K_{α}^* since the irrelevant operators dominate, but eventually when n , the number of blockings, is large enough $\lambda_a^n > h_a$ for the relevant operators and we will be taken away along the direction of the largest relevant operator. This relevant direction is called a renormalization trajectory (RT). The flow near K_{α}^* is illustrated at fig. 3.

If there are n relevant operators at a given fixed point we will denote it by $FP^{(n)}$ and it will require the tuning of n parameters to reach the critical surface. If there is only one relevant operator we can reach the critical point by changing any of the coupling constants. In the laboratory the tuning is performed by changing for instance the temperature. This will create a flow of $K_{\alpha} \equiv (K(\beta), \mu(\beta), \lambda(\beta), \dots)$ which eventually will cross the critical surface if the system has a ferromagnetic transition.

It is worth emphasizing that in relation to actual materials like Fe, Ni, Gd, etc. the coarse graining implemented by the RG is of course a purely mental process which allows us to understand universality. However, in the context of model calculations on a computer the situation is completely different. Since we have a detailed knowledge to the configurations which we generate by MC-simulations, we can perform the blocking described above and actually follow the flow in the coupling constant space $\{K_{\alpha}\}$. Also it should be emphasized that the position of the fixed point K_{α}^* on the critical surface depends on the specific RG-procedure we use. The critical surface itself in the infinite dimensional coupling constant space is independent of the specific procedure, as is the long distance physics, of course, but roughly speaking any point on the critical surface can serve as a fixed point if the RG-procedure is chosen appropriately. For instance, it is often convenient for analytical calculations to do the coarse graining of variables in momentum space. The lattice introduce a momentum cut off

$$\Lambda = \pi/a. \quad (3.19)$$

Reducing Λ corresponds to larger lattice spacing and therefore (in a not very precise way) to a blocking.

4.1. The Gaussian Fixed Point

In this section we will discuss in more detail the approach to a critical point belonging to a critical surface and how this approach relates to the usual renormalization known from field theory.

It is instructive to start by discussing the purely Gaussian case. If we perform the blocking, the action will after a few steps contain next to nearest neighbour interactions, higher derivative terms, etc. Rather than carrying out the analysis on the lattice in this concrete way (which can be done [1]), we will for the purpose of illustration work in the continuum with a cut off $\Lambda \sim \frac{\pi}{a}$ in momentum and appeal to the remarks at the end of last section concerning the freedom to choose a blocking procedure.

We consider the generalized Gaussian action:

$$H[\tilde{\phi}] = \frac{1}{2} \int d^d p \tilde{\phi}(p) D(p) \tilde{\phi}(-p)$$

$$D(p) = \tilde{k}_0 + \tilde{k}_1 \sum_r p_r^2 + \tilde{k}_2 (\sum_r p_r^2)^2 + \tilde{k}_3 \sum_r p_r^4 + \dots \quad (4.1)$$

By changing to dimensionless variables

$$q = a \cdot p$$

$$\phi(q) = a^{-\frac{d+2}{2}} \tilde{\phi}(p) \quad (4.2)$$

$$k_0 = a^2 \tilde{k}_0$$

$$k_1 = \tilde{k}_1$$

$$k_2 = a^{-2} \tilde{k}_2, \dots$$

we get

$$H[\phi] = \frac{1}{2} \int d^d q \phi(q) D(q) \phi(-q)$$

$$D(q) = k_0 + k_1 \sum_r q_r^2 + k_2 (\sum_r q_r^2)^2 + \dots \quad (4.3)$$

As is mentioned a convenient RG procedure in momentum space is to integrate the high frequency part: $\pi/3 < q \leq \pi$. In the Gaussian case this is a triviality since different momenta do not couple and we get (in the notation of last section)

$$\begin{aligned}
H'(\phi') &= \frac{1}{2} \int^{\pi/2} d^d \varphi \phi(\varphi) D(\varphi) \phi(-\varphi) \\
\phi_s(s\varphi) &= s^{-(d-2+\epsilon)/2} \phi(\varphi) \\
H_s(\phi_s) &= \frac{1}{2} \int^{\pi} d^d \varphi \phi_s(\varphi) D_s(\varphi) \phi_s(-\varphi) \\
D_s(\varphi) &= K_0 s^{2-\epsilon} + K_1 s^{-\epsilon} \sum_{\mathbf{r}} \varphi_{\mathbf{r}}^2 + K_2 s^{-2\epsilon} (\sum_{\mathbf{r}} \varphi_{\mathbf{r}}^2)^2 + \dots
\end{aligned} \tag{4.4}$$

From (4.4) we read off the RG transformation:

$$RG_s : \{K_\alpha\} \rightarrow \{s^{2-\epsilon} K_0, s^{-\epsilon} K_1, s^{-2\epsilon} K_2, \dots\} \tag{4.5}$$

and we have a fixed point at:

$$K_\alpha^* = \{0, K_1, 0, 0, \dots\} \tag{4.6}$$

provided $\epsilon = 0$. This point is called the Gaussian fixed point. It will clearly be a fixed point even if we enlarged the coupling constant space to include (potentially) non-trivial interactions like ϕ^4 interactions. The value of K_1 is arbitrary. If we fix it to 1 the actions (4.1)-(4.3) define just the massless free field in the continuum in the limit where $a \rightarrow 0$.

Already this trivial generalized Gaussian action allows us to emphasize a number of points:

- (1): at the fixed point the theory is scale invariant (massless).
- (2): In this case we have one relevant coupling constant (K_0). By choosing some values of K_2, K_3, \dots we get to the critical surface $K_\alpha = \{0, 1, K_2, K_3, \dots\}$ by fine tuning of the relevant coupling (in this case to zero). The physical correlation length $1/m_{\text{phys}}$ is related to the correlation length ξ measured in "lattice" or cut off units "a" by

$$1/m_{\text{phys}} = \xi a. \tag{4.7}$$

By the requirement that m_{phys} is unchanged during a blocking we relate the renormalization group transformation to a change in cut off "a" and fix the fine-tuning of the relevant parameter: $K_0 = m_{\text{phys}}^2 a^2$. The important point is that the free massive theory in the continuum is not defined at the critical point but by the fine-tuned approach of the relevant (mass²) coupling constant to the critical surface. The same would be

true if we had n relevant couplings. By fixing the physical value of these as in (4.7) the requirement that (long distance) physics is invariant under RG transformation, when we are near a critical surface, would fix the fine-tuning of the relevant parameter in terms of the cut off "a" just as we did for the relation $K_0 = m_{\text{phys}}^2 a^2$. Such relations describing the change in the bare coupling constant under a change of cut off, while keeping physics constant, are precisely the ordinary renormalization group equations of field theory!

- (3): At this point it might be confusing why we in general moved out in the infinite dimensional coupling constant space when we did the blocking in the last section. When we renormalize field theory we usually adjust only a few coupling constants. The RG transformations in the continuum do not lead us to an infinite dimensional coupling constant space. The reason is, the blocking procedure is much more precise than is needed for describing the long distance behaviour. However a blocking exactly reproduces all predictions for the variables which are not integrated over by the blocking. The expense is that one has to enter into an infinite dimensional coupling constant space. We could, and that is often done in MC-simulations, approach the continuum limit by just changing the few relevant couplings in the simplest discretized version of the continuum action. We would have no control over the change in correlation length when changing the couplings, but one could of course measure the correlation length.
- (4): The Gaussian fixed point is particular simple since we can do ordinary perturbation theory around it. Also it is easily seen in the linearized approximation around it that every operator θ (like $\int d^d x (\partial_\mu \phi)^n$) which has an engineering dimension d_θ (like $d_\theta = n(d/2 - 1) + k - d$) corresponds to an eigenvalue $\zeta_-(d_\theta)$. Therefore, in $d > 2$ there is only a finite number of relevant operators with respect to the Gaussian fixed point. It is believed to be true also for other fixed points and justify the statement made in the last section that the critical surfaces are large in $\{k_\alpha\}$.

4.2. Marginal Operators at the Gaussian Fixed Point: Triviality Versus Asymptotic Freedom

In 4 dimensions the operator $\int d^4x \Phi^4$ has as engineering dimensions zero, similar with all other actions corresponding to dimensionless coupling constants. For instance will the operator $\int d^4x \text{Tr } F^2$ in non-abelian gauge theories also have engineering dimension zero. In Sect. 5 we will discuss the lattice regularization of the gauge theories in more detail. Here we will only assume that the action can be taken over to the lattice in a sensible way.

An operator of dimension zero will be a marginal operator with respect to the Gaussian fixed point, corresponding to eigenvalue $S^0 = 1$. One has to go beyond the Gaussian approximation in order to discover whether it will become relevant or irrelevant. The corresponding couplings are called asymptotically free and non-asymptotically free, respectively. The canonical examples are a non-abelian $SU(N)$ gauge theory and a one-component Φ^4 theory.

For non-asymptotically free couplings one cannot have a renormalized coupling defined at the Gaussian fixed point. If we for the purpose of illustration define the renormalized coupling as the value of the bare coupling after applying n blockings such that:

$$S^n a = \text{fixed physical distance when cut off } 1/a \rightarrow \infty, \quad (4.7)$$

it is clear by definition that the renormalized coupling is smaller than the bare coupling, since the corresponding action was irrelevant with respect to the Gaussian fixed point. At the Gaussian fixed point the bare coupling is taken to be zero and the renormalized coupling will be even closer to zero. Therefore theories with only non-asymptotically couplings cannot define non-trivial continuum field theory at the Gaussian fixed point. They could however have other fixed points where a non-trivial theory could be defined. A search for such possible points is therefore of utmost importance in these theories (like Φ^4 , ordinary QED, etc.). At the moment there are indications that no such point can be found.

For asymptotically free theories the Gaussian fixed point is much more interesting since the renormalized coupling is larger than the bare coupling. One therefore has a chance that even if the bare coupling (by definition) is taken to zero when approaching the fixed point, the renormalized coupling might remain finite and in this way define a non-trivial interaction theory at the Gaussian field point. The important function which controls the approach to the continuum limit is the β -function.

4.3. The β -Function

Let us for simplicity start with a theory with only one coupling constant g^2 (like pure non-abelian gauge theory). For the regularized version on the lattice the change of this coupling constant will move us along a one-parameter line in the multi-parameter space created by blocking. $g^2 \rightarrow 0$ will bring us to the critical surface associated with the Gaussian fixed point.

When we are close to the critical surface the correlation length is large and we can find a change Δg^2 in g^2 such that

$$\begin{aligned} g'^2 &= g^2 - \Delta g^2 \\ \xi(g'^2) &= 2 \xi(g^2). \end{aligned} \quad (4.8)$$

This means that the long distance physics will be the same for g'^2 and g^2 provided we identify

$$a(g'^2) = \frac{1}{2} a(g^2). \quad (4.9)$$

Eq. (4.9) tells us how to take the continuum limit $a \rightarrow 0$ in such a way that it is independent of the cut off.

It is worth emphasizing that repeated RG-transformations ($s=2$) will result in a picture shown in fig. 4. When the number of blockings n is sufficiently large the coupling constant flow starting from g^2 will move along the RG-trajectory and will coincide with the $(n+1)^{\text{th}}$ RG-step starting from g'^2 : it is only the long distance physics which is identical for the choices g^2 , $a(g^2)$ and g'^2 , $\frac{1}{2}a(g'^2)$.

The equations (4.8-4.9) define the relation between g and a which leaves continuum physics invariant when $a \rightarrow 0$. This relation is named the β -function:

$$\beta(g) = -a \frac{d}{da} g(a). \quad (4.10)$$

The nice thing about the Gaussian fixed point is that we can calculate $\beta(g)$ for small g^2 by ordinary perturbation theory:

$$\beta(g) = -b_0 g^3 - b_1 g^5 + \dots \quad (4.11)$$

For an asymptotically free theory $b_0 > 0$, since this implies that $g(a)$ is decreasing when a is decreasing.

The scaling region is the region where g^2 is so small (a is so small) that within a given, required precision there will be no cut off dependence for physical observables. In the scaling limit

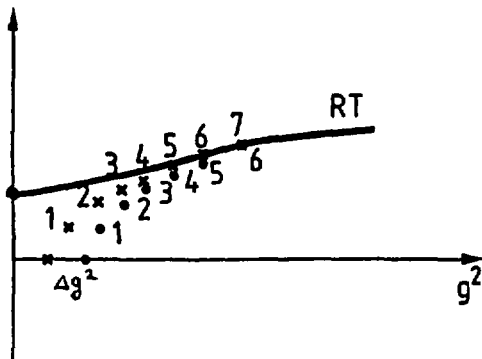

Fig. 4.

Successive blockings starting from g^2 (dots and $g'^2 = g^2 - \Delta g^2$ (x's) such that $\alpha(g'^2) = \frac{1}{2} \alpha(g^2)$

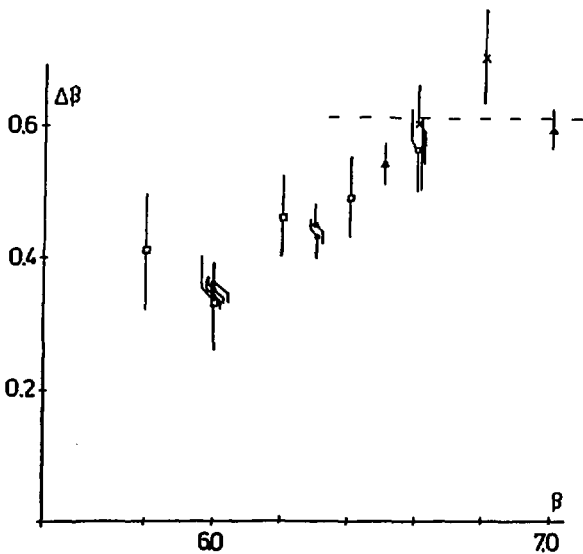

Fig. 5.

Plot of $\Delta\bar{\beta}(\bar{\beta})$, $\bar{\beta} = 6/g^2$ for SU(3).

The dashed line represents the perturbative two loop prediction

any dimensionful physical quantity behaves in a definite way as a function of g^2 . Since m_{phys} is independent of a we have:

$$a \frac{d}{da} m_{\text{phys}} = 0 \quad (4.12)$$

$$m_{\text{phys}} = \frac{1}{a} f(g) \quad (\text{by dimensional reasons}) \quad (4.13)$$

Therefore:

$$m_{\text{phys}} = c \cdot \frac{1}{a} e^{-\int^g dg' / \beta(g')} \quad (4.14)$$

Using only the two first terms in the expansion (4.11), which can be shown to be the only terms in the expansion which are independent of the regularization used, eq. (4.14) reads

$$m_{\text{phys}} = c \cdot \frac{1}{a} \cdot e^{-\frac{1}{2b_0 g^2}} (b_0 g^2)^{-\frac{b_1}{2b_0}} (1 + O(g^2)) \quad (4.15)$$

which are called asymptotic scaling. The non-perturbative aspect in this formula is the constant c which cannot be calculated within the perturbation theory.

For a given choice of g^2 on the lattice it is clearly of great importance to know how far we are from the universal first two terms in (4.11). A convenient measure for that can be taken from (4.8)-(4.9), namely the change in coupling constant necessary in order to change the correlation length (or lattice spacing "a") by a factor 2: introducing $\tilde{\beta}$ by:

$$\tilde{\beta} = 1/g^2 \quad (4.16)$$

we have from (4.10-4.11)

$$a \frac{d}{da} \tilde{\beta} = 2b_0 + O(1/\tilde{\beta}) \quad (4.17)$$

$$\Delta \tilde{\beta} = 2b_0 \log 2 + O(1/\tilde{\beta}) \quad (4.18)$$

$\Delta \tilde{\beta}$ can be measured in a convenient way by RGMC methods, as described below. Fig. 5 shows the result of measurements of $\Delta \tilde{\beta}$ for the SU(3) gauge theory.

4.4. Critical Exponents Near a Fixed Point

An essential argument in the outline of universality was based on the assumption that the critical exponents are determined by the fixed points. We will now show that this is true.

Let us for simplicity assume that there is only one relevant direction: the fixed point is $FP^{(1)}$. We will denote the correlation function (the Green function) $G(x)$ (assuming translational invariance on the lattice).

If we are close to the critical surface we can repeat the discussion in sect. 3 and write the linearized RG equations:

$$\begin{aligned} K_\alpha &= K_\alpha^* + \sum_{a_i} U_{a_i} h_{a_i}(\beta) \\ ((RG)^n K)_\alpha &= K_\alpha^* + U_{a_1} h_{a_1}(\beta) S^{n\lambda_{a_1}} + O(S^{n\lambda_{a_i}}) \\ h_{a_1}(\beta) &= h_{a_1}^0(\beta - \beta_c). \end{aligned} \quad (4.19)$$

The notation is as follows: (v_{a_1}) is the eigenvector for the relevant direction; $a_i, i > 1$ are a_1 indices for irrelevant directions. Since we are close to the critical surface $h_{a_1}(\beta)$ must be small, but eventually after a sufficient number of a_1 blockings only the relevant operator will dominate ($\lambda_{a_1} < 0, i > 1$) and we are on the RG trajectory.

From the definition of blocking we have (when x and $x/s^{n\lambda_{a_1}} \gg a$):

$$\begin{aligned} G(x; \{K_\alpha\}) &= S^{2\alpha n} G(x/s; \{(RG)^n K\}_\alpha) \\ \alpha &= (d-2+\eta)/2. \end{aligned} \quad (4.20)$$

Using (4.19) it is seen that we can finetune the approach to the critical surface: $\beta \rightarrow \beta_c$ in such a way that β drops out of $RG^n \{K_\alpha\}$:

$$\begin{aligned} h(\beta_n) S^{n\lambda_{a_1}} &= 1 \\ S^n &= |h_{a_1}^0(\beta - \beta_c)|^{-1/\lambda_{a_1}}. \end{aligned} \quad (4.21)$$

By (4.20) we get by a change in notation

$$\begin{aligned} G(x; \{K_\alpha(\beta)\}) \Big|_{\beta \rightarrow \beta_c} &= \xi(\beta) G(x/\xi(\beta); \{K_\alpha^* + U_{a_1}\}) \\ \xi(\beta) &\propto |\beta - \beta_c|^{-1/\lambda_{a_1}} \\ \alpha &= (d-2+\eta)/2. \end{aligned} \quad (4.22)$$

This is identical to the result obtained by the scaling hypothesis mentioned in sect. 3 provided $\xi(\beta)$ is identical as the correlation length. We see that the critical exponent ν is related to the (largest) relevant eigenvalue by

$$\nu = 1/\lambda_a. \quad (4.23)$$

Also η is determined by the fixed point. In fact, as already mentioned, $\xi^{-\alpha}$ is the unique scale factor for the field ϕ which leaves the behaviour of the $G(x, K_\alpha)$ invariant at the critical surface. Stated differently we can say only one, or very few, choices of η will result in a fixed point for our chosen RG-transformations.

Finally the critical exponent γ is also determined from (4.22) by integrating over x :

$$\begin{aligned} \chi(\beta) &\equiv \int d^d x G(x, \{k_\alpha(\beta)\}) = \\ &\xi^{2\alpha} \int d^d x G(x/\xi(\beta), \{k_\alpha^* + U_{a_1 \alpha}\}) = \\ &\xi^{2\alpha+d} \cdot \left[\int d^d y G(y, \{k_\alpha^* + U_{a_1 \alpha}\}) \right] \end{aligned} \quad (4.24)$$

or, since the last parenthesis has no β dependence:

$$(\beta - \beta_c)^{-\gamma} = \xi(\beta)^{2-\eta} = (\beta - \beta_c)^{-\nu(2-\eta)} \quad (4.25)$$

which is Fischer's scaling relation.

Again it should be emphasized that the scaling limit is defined as a finetuning to the critical surface.

4.5 MCRG Transformation: an Explicit Example

The whole formalism of RG-transformation described above has been useful in the past in the sense that it gave an intuitive understanding of universality, β -function, renormalization, etc., and it could be used to derive various scaling relations (of which only Fischer's have been mentioned here). However, by the use of modern fast computers one can simulate the lattice system mentioned and the blocking described can be explicitly performed. In this way one can follow the coupling constant flow in the space $\{K_\alpha\}$ and determine the critical surfaces and fixed points. The largest eigenvalues of

blocking give us directly the critical exponent ν . The eigenvalue is $S^{1/\nu}$ (see (4.23)). The exponent ν is determined by writing

$$(\Phi_S)_{X/S} = \lambda_S \sum_{X' \in B_S(X)} \Phi_{X'} \quad (4.26)$$

and determining the value of λ_S which gives a consistent blocking. We then have

$$\lambda_S = S^{-(d-2+\nu)/2}. \quad (4.27)$$

The essential problem is to find the values of the coupling constants $\{K_\alpha^{(1)}\}, \{K_\alpha^{(2)}\}, \dots$ from $\{K_\alpha^{(0)}\}$ obtained by blocking. Swendsen [3] has suggested a quite efficient method for dealing with this blocking.

One starts out with a 2^n lattice and an appropriate action. If we consider for instance a Φ^4 theory in 4 dimensions we can start with an action

$$H[\Phi] = \sum_n \left(\sum_r (\Phi_{n+r} - \Phi_n)^2 + r_0 \Phi_n^2 + g^2 \Phi_n^4 \right). \quad (4.28)$$

and generate a number of equilibrium configurations. For these configurations one does the blocking with $S=2$, effectively reducing the size of the lattice to $2^{n-1}, 2^{n-2}, \dots$.

On the reduced lattices the actions which give the same expectation values will have the form (after ℓ blockings)

$$H_\ell[\Phi] = \sum_\alpha K_\alpha^{(\ell)} S_\alpha(\Phi) \quad ; \quad S_\alpha = \sum_n S_{\alpha,n}. \quad (4.29)$$

At fig. 6 we show a typical class of interactions S_α which can be included in a practical fitting. (See [4, 5] for details about the implementation, also for gauge theories).

The best values of the coupling constants $K_\alpha^{(\ell)}$ after the ℓ th blocking can be determined in the following way: we define modified operators $\bar{S}_{\alpha,n}$ by the conditional expectation values:

$$\bar{S}_{\alpha,n} \equiv \frac{\int d\Phi_n S_{\alpha,n} e^{-\sum_\alpha \tilde{K}_\alpha S_{\alpha,n}}}{\int d\Phi_n e^{-\sum_\alpha \tilde{K}_\alpha S_{\alpha,n}}}, \quad (4.30)$$

where the integration is only over the local variable Φ_n and all neighbour fields are kept fixed. If the arbitrary values \tilde{K}_α are close to the correct ones we have:

$$\bar{S}_{\alpha,n}(\tilde{k}) = \bar{S}_{\alpha,n}(k) - \frac{\partial \bar{S}_{\alpha,n}}{\partial \tilde{k}_{\beta}} (\tilde{k}_{\beta} - k_{\beta}). \quad (4.31)$$

For the correct values of $\{\tilde{k}_{\alpha}\}$ we can say the expectation value of $S_{\alpha,n}$ and $\bar{S}_{\alpha,n}$ are identical with respect to the partition function since $\bar{S}_{\alpha,n}(k)$ is nothing but the expectation value of $S_{\alpha,n}$ with respect to a fixed background, over which we integrate afterwards:

$$\langle \bar{S}_{\alpha,n}(k) \rangle = \langle S_{\alpha,n}(k) \rangle. \quad (4.32)$$

Taking average values of (4.31) now yields

$$k_{\beta} = \tilde{k}_{\beta} - \sum_{\alpha} \left[\frac{\partial \langle \bar{S}_{\alpha} \rangle}{\partial \tilde{k}_{\beta}} \right]_{\beta\alpha} (\langle \bar{S}_{\alpha} \rangle - \langle S_{\alpha} \rangle) + O((k - \tilde{k})^2). \quad (4.33)$$

This provides an iterative scheme for the determination of $\{K_{\alpha}\}$ of a given ensemble of configurations. Since the values for $\langle S \rangle$ and $\langle \bar{S} \rangle$ are obtained from a common set of configurations, fluctuations are likely to cancel in the difference. One should be aware that the integrals for $\bar{S}_{\alpha,n}$ in general will have to be done numerically. Only in the original application of Swendsen to the Ising model they can be done analytically.

In practice the method works quite well and the K_{α} 's can be determined up to two digits ($\{4, 5\}$).

Finally we can, from the now calculated values of $\{K_{\alpha}^{(l)}\}$, construct the RG-flow and locate possible fixed points. Moving close to the fixed point and doing new simulations we can construct the linearized RG-transformations simply by using

$$(RG)_{\alpha\beta} \approx \frac{\partial K_{\alpha}^{(l+1)}}{\partial K_{\beta}^{(l)}} \quad (4.34)$$

and as described in sect. (4.4) the knowledge of $(RG)_{\alpha\beta}$ allow us to determine ν , while the scale factor used gives γ and therefore γ (by Fischer's scaling relation).

5. THE CONTINUUM LIMIT FOR NON-ABELIAN LATTICE GAUGE THEORIES

5.1. The Lattice Action

The non-abelian gauge theories of course deserves special attention because of their importance in nature. They have the (probably

unique [6]) feature of being asymptotically free in four dimensions. Further, it turns out that there is a natural way in which the local gauge invariance can be implemented on the lattice.

Already in the continuum one encounters problems with gauge invariance of the Green functions, since these involve for instance charged scalar fields at different points. Formally one can make gauge invariant objects by connecting the fields by path ordered exponentials:

$$\phi^+(x) P \left[e^{i \int_{y \rightarrow x} A_\mu^a dz_\mu} \right] \phi(y). \quad (5.1)$$

This construction can be taken over to the lattice. The ordinary kinetic term for a $SU(N)$ scalar field ϕ in the fundamental representation is changed as follows:

$$\begin{aligned} (\phi_{n+\mu}^+ - \phi_n^+) (\phi_{n+\mu} - \phi_n) &= -\phi_{n+\mu}^+ \phi_n - \phi_n^+ \phi_{n+\mu} + \phi_{n+\mu}^+ \phi_{n+\mu} + \phi_n^+ \phi_n \rightarrow \\ &-\phi_{n+\mu}^+ U_{n+\mu, n} \phi_n - \phi_n^+ U_{n, n+\mu} \phi_{n+\mu} + \phi_{n+\mu}^+ \phi_{n+\mu} + \phi_n^+ \phi_n. \end{aligned} \quad (5.2)$$

where $U_{n+\mu, n} (\equiv U_{n, n+\mu}^{-1})$ is an $SU(N)$ matrix living on the link connecting n and $n+\mu$. $U_{n, \mu} (\equiv U_{n+\mu, n})$ acts as a gauge connector like $P e^{i \int_{dx_\mu} A_\mu}$ in (5.1) and we can formally write in the continuum limit:

$$U_{n, \mu} = e^{i a A_{n, \mu}^b T^b}. \quad (5.3)$$

If we expand (5.2) in terms of the lattice spacing we get the usual continuum kinetic part $(D_\mu \phi)^+ (D_\mu \phi)$. The local gauge transformations on the lattice are $SU(N)$ transformation living on the sites:

$$\phi_n \rightarrow V_n \phi_n \quad (5.4)$$

$$U_{n, n+\mu} \rightarrow V_n U_{n, n+\mu} V_{n+\mu}^{-1}$$

(5.4b) transforms exactly like the path ordered exponential and clearly (5.2) is gauge invariant.

To construct an action for the pure gauge part of the theory we also use the knowledge we have from the continuum theory of path

ordered exponentials: for a small loop of area element $dA_{\mu\nu}$ we have:

$$\text{Tr} P \left[e^{i \oint A_r dx_r} \right] \approx N. \quad (5.5)$$

By taking the smallest possible loop on the lattice, namely going around one plaquette \square in the plane $\mu\nu$, we get

$$\text{Tr} \left(1 - \frac{1}{2} (U_{\square} + U_{\square}^{-1}) \right) / N \quad (5.6)$$

$$U_{\square} \equiv U_{nr\mu, n} U_{n, n+\nu} U_{n+\nu, n+\nu+\mu}^{-1} U_{n+\nu+\mu, n+\mu}^{-1}$$

and it is easy to prove, expanding in lattice distance a that (5.5) is recovered in the limit $a \rightarrow 0$. Our final action would therefore look like:

$$S(\Phi, U) = -k \sum_n \left(\sum_{\mu} \text{Re} \Phi_{nr\mu}^+ U_{nr\mu, n} \Phi_n \right) + \mu \Phi_n^+ \Phi_n + \lambda (\Phi_n^+ \Phi_n)^2 - \beta \sum_{n, \mu < \nu} \text{Re Tr} U_{\square, n, \mu\nu}. \quad (5.7)$$

where we have introduced the gauge coupling g^2 by

$$\beta = 1/(g^2 a^{4-d}). \quad (5.8)$$

Of course one could use many other versions of, for instance, the last term in (5.7). The particular form invented in (5.6) is called the Wilson action, but when blocking we will generate all kinds of next to nearest neighbour terms of the same form. One could include other representations of $SU(N)$. Gauge invariance is the only severe restriction (of course).

One could also add fermions to the model (5.7). Fermions are difficult to add, however, because of the famous doubling problem of fermions on the lattice [7]. It can be done, however, either by use of the so-called Susskind-fermions or Wilson-fermions. Both approaches have drawbacks and in addition the computer simulations involving fermions are very difficult because of the anti-commuting character of fermions. This makes realistic simulations of sectors of QCD, where dynamical fermions are expected to play an important role, very difficult.

5.2. The String Tension and Other Observables in Lattice QCD

The non-perturbative MC-methods described in the last sections allow us to address a lot of questions involving non-abelian field theory and which are of extreme interest in today's theoretical and

experimental physics. Let us give a (partial) list of topics which has been under investigation during the last couple of years:

1) Hadron masses: This is the principal test of QCD as the long distance theory of hadrons. We should, by our computer simulations, extract the ratios between the hadronic masses observed in nature. As already mentioned, the role of the dynamical fermions is the main obstacle, and although they can be put on the lattice, sometimes the interpretation of the right symmetries necessary to prospect out the relevant particle states is not straight forward. The "non-local" character of the fermions makes the computer simulations very time consuming and we are taking about thousands of hours of super-computer time before we can hope to obtain a reproduction of the Rosenfeld table [8].

2) Confinement and the QCD string: As will be discussed shortly it is relatively easy to address the question of the central potential between heavy quarks [9]. The flux distribution of the string would be very interesting to measure, but is presently waiting for new techniques of important sampling [10, 11], as will also be discussed. Attempts have been made to measure the spin dependence of the qq forces [12, 13] and the existence of a possible "confinement" potential between quarks in the adjoint representation [14 - 16]. The existence of such a potential (if only out to a certain critical distance r_{crit}) would tell us a lot about the confinement mechanism ("dimensional reduction" [15, 17]). Also the role of instantons in the QCD vacuum has been addressed [18].

3) High temperature and high density: Clearly the understanding QCD of QCD at high temperature and high densities is important. It is relevant for heavy ion physics and for cosmology (the early universe). High temperature effects can be studied in detail by MC-techniques and the questions of deconfinement and restoration of broken symmetry can be addressed in a non-perturbative way. In fact, this is an area where the lattice treatment has added a lot to our understanding of these phenomena [19].

The treatment of high density (where "deconfinement" should also occur) is more complicated because the chemical potential for fermions becomes complex in the Euclidean formalism. Again an effective treatment of this problem calls for new techniques of importance sampling in the MC-procedure.

4) The Weinberg-Salam model, GUT: It is still an open question whether the standard model and G(rand) U(nified) T(theories) exist in a strict non-perturbative field theoretical sense. The fact that the Φ^4 theory (presumably) is trivial may have important implications for the Higgs mechanism, and therefore the whole philosophy of GUT. On the other hand the existence of non-trivial fixed points might lead to restrictions on couplings and predictions of the masses of Higgs particles [20, 21]

5) Chiral symmetry breaking: The chiral symmetry breaking in QCD is believed to be a truly non-perturbative phenomenon. Although one has to face the already mentioned problem of fermions on a lattice, the question can be addressed and the breaking seems to be confirmed [22]. Interesting questions concerning the restoration of chiral symmetry at high temperature is still under debate [23]. Finally a number of questions concerning hierachial structures of technicolor theories can be addressed by lattice techniques [24].

As can be seen, lattice MC methods can treat quite a broad spectrum of topics.

We shall here only discuss in some detail the oldest and still not completely settled question: confinement and the string tension in pure non-abelian gauge theories.

Because of asymptotic freedom the effective coupling constant for a non-abelian gauge theory is vanishing at small distances and a consistent perturbation theory can be developed, as described in the last section. What happens for large distances cannot be addressed by perturbation theory and we do not know. It has been popular to assume that the effective coupling constant would grow to infinity thereby giving a heuristic proof of the confinement of quarks in QCD. The more quantitative formulation of the concept of quark confinement was first given by Wilson and is based on the observation that the expectation value of a path ordered line integral around a rectangular loop of size $R \times T$, $T \gg R$ can be related to the static energy of a heavy quark - antiquark pair, created at $T=0$, separated by R and kept at that distance for a time T and subsequently annihilated:

$$\langle \text{Tr} P [e^{i \oint_{R \times T} dx_\mu A_\mu}] \rangle = e^{-V(R)T} \quad (5.9)$$

$$\langle (\cdot) \rangle \equiv \frac{\int \mathcal{D}A(\cdot) e^{-\frac{1}{4g^2} \int d^4x \text{Tr} F_{\mu\nu}^2}}{\int \mathcal{D}A e^{-\frac{1}{4g^2} \int d^4x \text{Tr} F_{\mu\nu}^2}} \quad (5.10)$$

In an abelian gauge theory we expect the potential energy to correspond to a Coulomb potential:

$$V(R) \sim 1/R \quad (5.11)$$

as can in fact be verified by a perturbative calculation. In the non-abelian case it is believed (and is a hope) that one has a confining potential

$$V(R) \sim c \cdot R \quad (5.12)$$

Eq. (5.12) means that the expectation value (5.9) goes as $e^{-c(\text{Area of loop})}$, which has become the famous criterion for confinement. (5.9) has the advantage that the path ordered integrals, the so-called Wilson loops, are very convenient observables on the lattice: they are simply products of $2(R+T)$ links around the rectangle enclosing $R \times T$ plaquettes.

In principle the MC-measurement is straightforward: one fixes β , generates a number of vacuum configurations for each of these one-measure Wilson loops of various sizes R (and T) and can now test whether the functional form (5.12) is correct. If we denote a Wilson loop enclosing and $R \times T$ rectangle by $W_{R,T}$

$$W_{R,T} = \text{Tr} \left[\prod_{\ell \in \text{Boundary}(R \times T)} U_\ell \right], \quad (5.13)$$

one could imagine 3 scenarios: the interaction between the two stationary heavy quarks, separated by a distance R , could be mediated by gluons, which are effectively massive, massless (like in perturbation theory at short distances) or the interaction could be of a more complicated nature, giving rise to a linear, confining potential like the one in (5.12). In addition to these interaction terms there will be a self-energy part where gluons are emitted and absorbed by the same heavy quark. This is a short distance singularity which we have introduced by hand by putting in a infinite heavy point-like particle. Therefore it can only be removed by hand and the contribution is not expected to scale like other physical quantities. It will give a contribution of the proportional to the length of the perimeter:

$$\begin{aligned} \text{self-energy} &= C(\beta) \cdot (T+R) \\ &\approx C(\beta) T \quad (R \ll T). \end{aligned} \quad (5.14)$$

In conclusion we expect the Wilson loop to behave in one of the following ways for $T \gg R$

$$\left\langle \prod_{R \in \text{Boundary}(R \times T)} U_R \right\rangle = \exp\left(-C(\beta) + \frac{C(\beta)}{R} e^{-m(\beta)R} + \dots\right) T \quad (5.15a)$$

$$= \exp\left(-C(\beta) + \frac{C(\beta)}{R} + \dots\right) T \quad (5.15b)$$

$$= \exp\left(-C(\beta) + \sigma(\beta)R + \dots\right) T. \quad (5.15c)$$

It can easily be proven by expanding $e^{-\beta \sum_a \text{Re Tr } U_a}$ in powers of β that in the strong coupling limit $\beta \rightarrow 0$ (that is: far from the continuum limit) $\sigma(\beta)$ is different from zero, even in an abelian lattice gauge theory. (In the non-abelian case we assume the heavy quarks are in the fundamental representation, as is implicit in eq. (5.13)). For quarks in the adjoint representations it is not true. They can be screened by the gluons, which are in the same representation of $SU(N)$. For the abelian gauge theory one expects a second order phase transition for a finite β_0 such that $\sigma(\beta)$ will be zero for $\beta > \beta_0$, where a Coulomb-potential should be observed, corresponding to (5.15b). Although it is generally believed that this scenario is true, the numerical analysis of the situation has turned out to be more involved than first expected. [5, 25]

The philosophy for the non-abelian $SU(N)$ theory was to prove that no such phase transition took place and that $\sigma(\beta)$ did not vanish for any value of β . Of course one should be more precise. If we want $\sigma(\beta)$ to represent a string tension that survives in the continuum limit $\beta \rightarrow \infty$ it must scale. $\sigma(\beta)$ is dimensionless and measured in lattice units. The physical string tension σ_{phys} has dimension $(\text{mass})^2$:

$$\sigma(\beta) = \sigma_{\text{phys}} a^2(\beta), \quad (5.16)$$

where the universal behavior of $a(\beta)$ for β large was described in the last section.

In four dimensions $a(\beta)$ vanish exponentially with β , which means that the number of lattice spacing required to reach a fixed physical distance is growing exponentially, and both for $SU(2)$ and

SU(3) there are at most a quite small window, where $\sigma(\beta)$ is still large enough to be measured with reasonable precision and where we have confidence that the the scaling behaviour is governed by the perturbative β -function. In fig. 7 the latest measurements of the string tension for SU(3) using various modifications of the simple Wilson action (5.7) is shown [26]. For SU(2) the latest high precision measurements indicate that there might be trouble with the scaling of $\sigma(\beta)$ [27].

At this point one should be aware of two things. First the extraction of $\sigma(\beta)$ from the raw data (i.e. the measured values of the Wilson loops) is not a straightforward process. For small R we are clearly probing perturbative QCD, not non-perturbative effects like a string tension. Where is the cross-over, if there is a sharp cross-over? And even in the region where the string dominates, the dynamics of the string might be important (see later). Such problems are common to most MC-measurement, which in this respect has a lot in common with real experimental physics. Secondly one should not forget that there is nothing magically with a linear potential. Confinement does not need a linear potential, - and confinement needs not be true! In fact we are trying to test whether it is true. The linear potential got its almost universally accepted status because of the old Regge theory (linear Regge trajectories) for hadrons, because the strong coupling expansions (far from continuum physics) led to such a potential and no phase transitions were observed, because it can be proven that a potential cannot grow faster in any reasonable, acceptable field theory and because it admits a simple interpretation in terms of a color electric flux tube connecting the quark and antiquark, but not being allowed to spread out the vacuum fluctuations of the color magnetic field (a dual super conductor). But, of course, none of these observations prove confinement with a linear potential.

5.3. The String Tension in Three Dimensions and String Dynamics

The existence of a continuum string tension is much more well established in three-dimensional non-abelian gauge theories. Maybe this is not so surprising if one recalls that in two dimension confinement is a triviality since already the Coulomb potential grows **linearly**, while in five and higher dimensions we have no confinement. The MC-measurements in three dimensions illustrate nicely the remarks above on the amount of "massage" one has to perform in order to get a

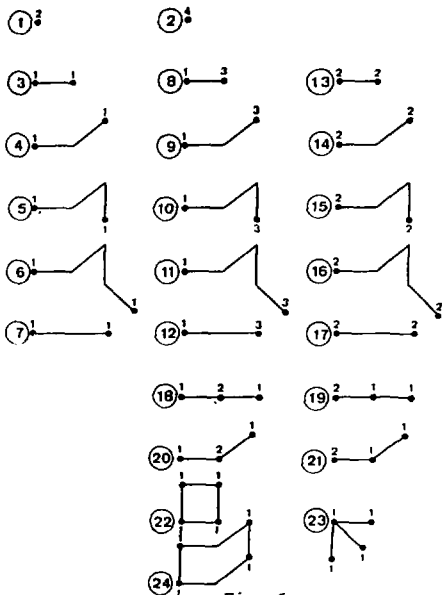

Fig. 6.

The various interactions included in the expansion $\sum_{\alpha} K_{\alpha} S_{\alpha}(\phi)$

Terms 1 and 3-7 are quadratic in ϕ ,

terms 2 and 8-24 are quartic in ϕ .

All respect $\phi \rightarrow -\phi$.

The numbers at the sites indicate the power of ϕ

clear signal for the string tension. It also illustrates that with sufficient insight in the physics it can be done and one can even address in a quantitative way the question of string dynamics, thereby showing the ability of MC-simulations to penetrate to non-perturbative regions, which has until now been inaccessible by other methods.

The scaling in three dimensions is different, for dimensional reasons, than in four dimensions. The approach to the expected critical point $\beta = \infty$ is much faster in the sense that $Q(\beta) \sim 1/\beta$ (see (5.8)) instead of having an exponential fall off in β .

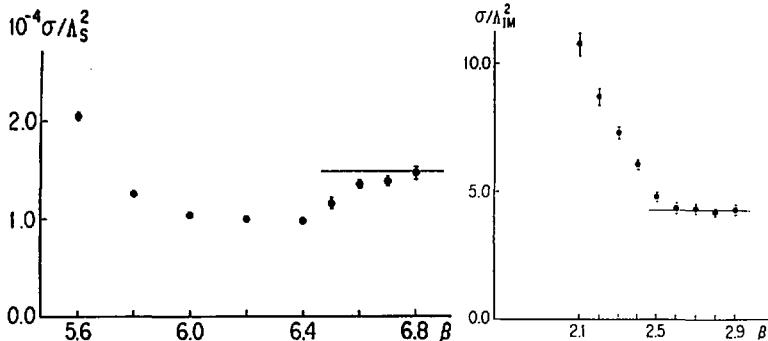

Fig. 7.

Measurements of the string tension for the Wilson action and a so-called improved action. $\beta \sim 1/g^2$, but the second action is more complicated and the β -range is therefore different. Λ^{-1} is a physical length as in eq. (4.15) and for scaling σ/Λ^2 should be constant

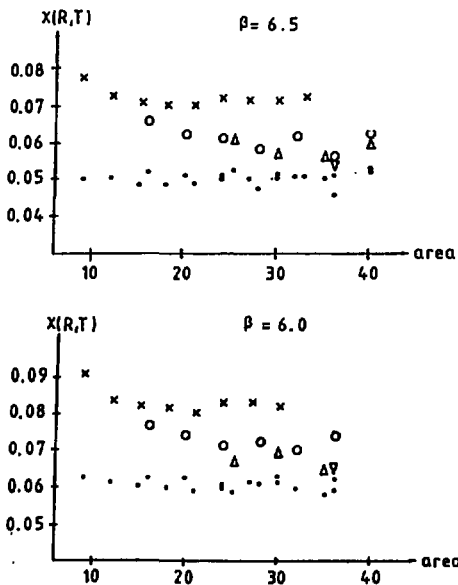

Fig. 8. The Creutz ratios for different areas and two values of $\beta = 4/g^2$. The black dots represent the Creutz ratios corrected for string vibrations, x corresponds to $\chi(3, T)$; o corresponds to $\chi(4, T)$; Δ corresponds to $\chi(5, T)$; ∇ corresponds to $\chi(6, T)$

In order to extract the area term from the measured Wilson loops $W_{R,T}$ it is convenient to get rid of the perimeter terms. Creutz devised a simple trick [28], namely taking the ratio between various Wilson loops with the same perimeter but different area. If we assume that we have a reasonable representation of $W_{R,T}$ as

$$W_{R,T} \equiv \prod_{\ell \in \text{Boundary}(R \times T)} U_{\ell}$$

$$W_{R,T} = \exp(-(\sigma(\beta)RT + (\psi(\beta)R+T) + d(\beta) + \dots)) \quad (5.17)$$

for R and T large enough, we define the so-called Creutz ratios as (for instance)

$$\chi(R,T) = -\log \left[\frac{W_{R,T} \cdot W_{R-1,T-1}}{W_{R,T-1} \cdot W_{R-1,T}} \right] \simeq \sigma(\beta) + O\left(\frac{1}{R}, \frac{1}{T}\right). \quad (5.18)$$

In fig. 8 these ratios are plotted for various values of β and although some convergence is seen, no clear picture emerges. Either there is no string tension or $1/R, 1/T$ corrections spoil a clear extraction of σ in (5.18). It can be argued that the corrections are not likely to be of perturbative nature since the correlation length ξ is small compared to R . They have to come from the dynamics of the string!

Fortunately the low frequency dynamics of the string can be addressed in very general terms, as first realized by Lüscher [29]. If we assume we have an effective action S_{eff} for the transverse vibrations of the string $X_T(\underline{t}, z)$ with endpoints fixed at $z=0$ and $z=R$:

$$S_{\text{eff}} = \alpha \int dt \int_0^R dz \left((\partial X_T)^2 + c_1 (\partial^2 X_T)^2 + \dots \right) \quad (5.19)$$

only the first term is relevant for large distances.

Is the classical ground state $\langle X_T(z,t) \rangle = 0$ stable to quantum fluctuations? The answer is "no" since the variance $\langle X_T^2(z,t) \rangle$ diverges:

$$\langle X_T^2(z,t) \rangle \sim \int_{1/R}^{1/a} \frac{d^2 k}{k^2} e^{ik \cdot (X_T=0)} \sim \log \frac{R}{a}. \quad (5.20)$$

Massless fluctuations want to delocalize the string completely and only finite size effects provide a lower cut off in frequencies and prevent this.

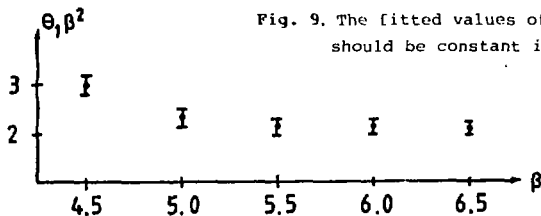

Fig. 9. The fitted values of $\sigma(\beta) \beta^2$ which should be constant in the scaling region

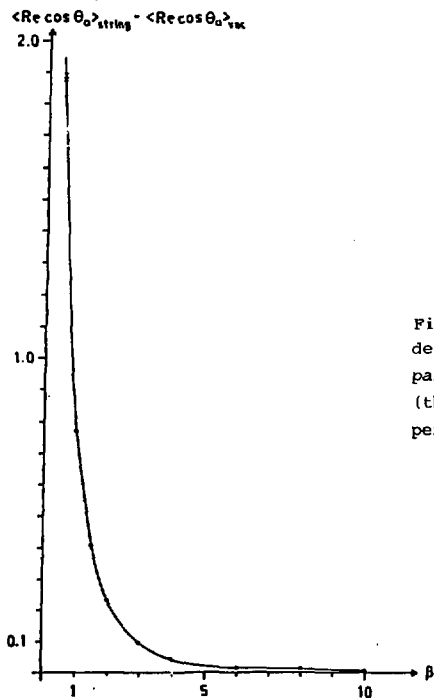

Fig. 10. The measured energy density inside the string compared to the exact values (the curve). The agreement is perfect

On the lattice we get a roughening transition when the gauge coupling β becomes so weak that entropy will beat the finite energy gap required to make any fluctuations of the string at all. For $\beta > \beta_{\text{rough}}$ we expect a transverse extension of the size (5.20). All the measurements shown in fig. 8 are for $\beta > \beta_{\text{rough}}$.

These massless modes lead to an (almost) universal correction to the pure confining potential (5.12) of the form

$$V(R) = \sigma R - \frac{(d-2)\pi}{24R} + O(1/R^3) \quad (5.21)$$

called the universal Lüscher term. The universality (no coupling constants enter) is due to the fact that it is nothing but the Casimir effect: it is a finite size effect imposed on the transverse modes X_T by the requirement that $X_n(t, z)$ should vanish at $z=0$ and $z=R$. In fact we can easily calculate the zero mode fluctuations of the effective action (5.19) if only the leading term is kept: since the eigenmodes are just ordinary harmonic oscillators with frequencies $\omega_n = \pi n/R$ we get:

$$\begin{aligned} \Delta V(R) &= \frac{1}{2} \sum_{n=1}^{\infty} \omega_n = (\text{regularized}) \\ &= \frac{1}{2} \sum_{n=1}^{\infty} \omega_n e^{-\omega_n/\Lambda} = \frac{\pi}{2R} \sum_{n=1}^{\infty} n e^{-\frac{n\pi}{R\Lambda}} \\ &= -\frac{\Lambda}{2} \alpha \frac{\partial}{\partial \alpha} \sum_{n=1}^{\infty} e^{-\alpha n} \Big|_{\alpha = \frac{\pi}{R\Lambda}} \quad (5.22) \\ &= \frac{\Lambda^2 R}{2\pi} - \frac{\pi}{24R} + \frac{1}{R} O\left(\frac{1}{R\Lambda}\right). \end{aligned}$$

The first part is a volume contribution, a quadratic divergence independent of finite size. The next term is a genuine finite size effect. The factor $d-2$ in (5.21) is just counting the number of transverse dimensions. The calculation can be refined to include the finite size effect when T is not infinite either.

When these universal $1/R$ corrections are taken into account we get a corrected value for the Creutz ratios, also shown in fig. 8, and a very nice consistent value of $\sigma(\beta)$ can be extracted. Further $\sigma(\beta)$ can be plotted for various values of β and compared with continuum scaling. As is seen in fig. 9 perfect scaling is observed. [30, 31]

It should be emphasized that the dynamics of the QCD string is important to understand. First it is a long standing conjecture that pure non-abelian gauge theories are strictly equivalent with some kind of bosonic string theory. This was in fact the main motivation when Polyakov formulated his new quantization of the bosonic string. In order to make contact with QCD it was necessary to have a consistent formulation of the string theory also in 4 dimensions. Secondly, the string dynamics will surely be of importance if we want to understand in detail the hadronization processes.

5.4. Limitations of MC and the Quest for Intelligent Important Sampling

As has been apparent from the discussion above, the use of MC methods, especially in 4 dimensional QCD, has been limited by two factors: the exponential vanishing of the dimensionless physical observables, like $\sigma(\beta)$, when we approach the continuum limit and the exponential vanishing of our favorite observables like the Wilson loop when we want to probe energies large compared to the vacuum. While the first limitation is impossible to remove since it is the very essence of quantum field theory, viewed as systems of generalized spins approaching their critical point, the second limitation is due to our present lack to generate anything but vacuum fluctuations by MC-updating algorithms.

The reason that the Wilson loops fall off exponentially with the potential energy $V(R)$ and therefore (assuming confinement) with the distance R is that we are trying to extract a signal of increasing energy from vacuum. The signals will become exponentially small when they are most interesting and farthest from perturbative physics, and we have no chance of beating this exponential fall off by MC, since statistics only improve by $1/\sqrt{N}$, where N is the number of updatings.

However, if we look at physics, the situation seems not unavoidable. The separation of a quark-antiquark pair does not cause the decay of any observable! If we disregard string vibrations nothing is changed locally, say in the midpoint between the $q\bar{q}$ pair, when we increase the distance. The local color electric field strength of the flux tube is unchanged (if we have confinement).

Clearly the only problem is our rather stupid importance sampling of gauge configurations. Pure vacuum configurations have very little to do with the dominating field configurations for a $q\bar{q}$ system separated at large distances. This problem is generic to all MC-measurements. Can it be circumvented? No definite answer is known yet, but it is worth emphasizing that the potential gains are enormous, much larger than what any new super-computer can give us. For that purpose let us discuss a toy model where a relevant importance sampling can be devised.

Two-dimensional abelian gauge theory is of course a trivial theory and can be solved exactly. Nevertheless it is hard to measure Wilson loops by the reasons just mentioned, especially in the strong coupling region. If we could only include the Wilson loop in the action everything would be changed, we would generate relevant con-

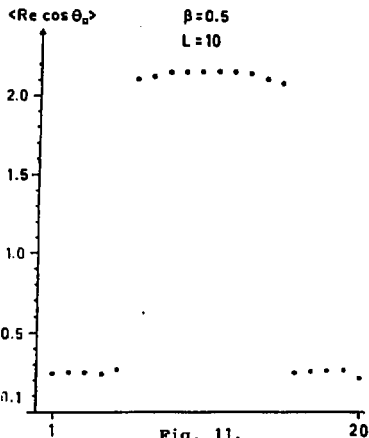

Fig. 11.
Picture of the QED string in 2 dimensions.
The charges are separated 10 lattice units

figurations. The problem with doing this is that the " i " in the exponent of the path integral makes the action complex. Updating algorithms like the Metropolis method or the heat bath method turn nonsense. One standard method for generating configurations with a prescribed probability distribution works, however! The Langevin equation

$$\frac{dX(t)}{dt} = - \frac{\delta S(X(t))}{\delta X} + \eta(t), \quad (5.23)$$

where t is a fictitious time; and $\eta(t)$, a Gaussian distributed random variable, will generate configurations $X(t)$ distributed according to $e^{-S(X)}$ in the limit $t \rightarrow \infty$. The equation makes formal sense even if S is complex and it works! (in the case considered here). At fig. 10 we have shown the measured and the calculated string tension on a 20^2 lattice (or various values of β). The agreement is perfect. Furthermore, by choosing an appropriate importance sampling one will usually obtain other benefits. In this case our configurations directly give us a picture of the string as is shown in fig. 11 (see ref. [10, 41] for details). The expectation value of a Wilson loop separated by the distance shown at fig. 11 is 10^{-100} . It would just be impossible to measure by any conventional methods. The gain by a relevant importance sampling is obvious.

The method of complex Langevin has been applied by two various systems. The principal chiral model in a (complex) external field has been simulated by the method and again impressive results were obtained [31]. However, for reasons not fully understood, it is not a completely reliable method, and it seems hard to judge in which applications it can be trusted [11, 33]. Therefore we have to discard it at the moment as a reliable tool. The examples where it works show on the other hand the extreme significance of inventing new methods for relevant importance sampling.

6. CONCLUSION

We have tried to convince the reader that MC-methods, having their roots in the intimate connection between field theory and the theory of critical phenomena, is a viable method for addressing a broad class of non-perturbative questions of importance in contemporary high energy physics. It is not a good substitute for an analytic understanding, but whether we like it or not, we have to face our inability in making fast enough progress by purely analytical tools. MC-methods are here to stay, especially since the computer power available is still increasing fast, and they will be very valuable both for getting out hard numbers and for testing the correctness of new ideas.

References

The general description of RG-technique can be found in many versions. Here will only be mentioned a few:

- (a): F. Ravndal: "Scaling and Renormalization Groups", Nordita lecture notes, Copenhagen 1975-76.
- (b): S.-K. May: "Modern Theory of Critical Phenomena". Frontiers in Physics No. 45. Benjamin Publ. Co. 1976.
- (c): D.J. Amit: "Field Theory, the Renormalization Group, and Critical Phenomena". McGraw-Hill 1978.
- (d): K.G. Wilson and J. Kogut, Phys.Rep. 12C (1974) 77-199.
- (e): P. Hasenfratz: "Monte Carlo Renormalization Group Methods and Results in QCD". Erice Lectures 1984.

- [1] T.L. Bell and K. Wilson, Phys.Rev. B11 (1975) 3431.
- [2] P. Hasenfratz, in: "Recent Developments in Quantum Field Theory" Eds. J. Ambjørn, B. Durhuus and J.L. Petersen. North-Holland 1985.

- [3] R.H. Swendsen, *Phys.Rev.Lett.* **52** (1984) 1165; *ibid.* 2321.
- [4] C.B. Lang, *Nucl.Phys.* **B265** [FS15] (1986) 630.
- [5] C.B. Lang: "Renormalization Flow in Lattice QED". FSU-SCRI-86-38 (to appear in *Nucl.Phys.B*).
- [6] H.D. Politzer, *Phys.Rep.* **C14**;
 - D.J. Gross and F. Wilczek, *Phys.Rev.* **D8** (1974) 2633;
 - S. Coleman and D.J. Gross, *Phys.Rev.Lett.* **31** (1973) 997.
- [7] H.B. Nielsen and M. Ninomiya, *Nucl.Phys.* **B185** (1981) 20.
- [8] For the latest results see for instance:
 M. Fukugita, Y. Oyanagi and A. Ukawa: "Langevin Simulation of Full QCD Hadron Mass Spectrum on a Lattice", RIFP-686.
- [9] P. de Forcrand, G. Schierholz, H. Schneider and M. Teper, *Phys. Lett.* **160B** (137) 1985;
 - J. Flower and S.W. Otto, *Phys.Rev.* **D34** (1986) 1649.
- [10] J. Ambjørn, M. Flensburg and C. Peterson, *Phys.Lett.* **159B** (1985) 335.
- [11] J. Ambjørn, M. Flensburg and C. Peterson, *Nucl.Phys.* **B275** [FS17] (1986) 375.
- [12] P. de Forcrand and J.D. Stack, *Phys.Rev.Lett.* **55** (1985) 1254.
- [13] C. Michael, *Proceedings: Wuppertal workshop 1986*.
- [14] C. Bernard, *Phys.Lett.* **108B** (1982) 431; *Nucl.Phys.* **B219** (1983) 341.
- [15] J. Ambjørn, P. Olesen and C. Peterson, *Nucl.Phys.* **B240** [FS12] (1984) 189; *ibid.* 577.
- [16] A. Huntley and C. Michael. CERN-preprint TH. 4 544/86.
- [17] J. Ambjørn and P. Olesen, *Nucl.Phys.* **B170** [FS1] (1980) 60;
 - P. Olesen, *Nucl.Phys.* **B200** [FS4] (1982) 381.
- [18] I.A. Fox, G. Gilchrist, M.L. Laursen and G. Schierholz, *Phys. Rev.Lett.* **55** (1985) 749;
 - Y. Arian and P. Woit, *Nucl.Phys.* **B268** (1986) 521; *Phys.Lett.* **183B** (1987) 341;
 - M. Göckeler, A.S. Kronfeld, M.L. Laursen, G. Schierholz and U.-J. Wiese. DESY-preprint 86-107.
- [19] A.D. Kennedy, J. Kuti, S. Meyer and B.J. Pendleton, *Phys.Rev. Lett.* **54** (1985) 87;
 - S.A. Gottlieb, A.D. Kennedy, J. Kuti, S. Meyer, B.J. Pendleton, R.L. Sugar and D. Toussaint, *Phys.Rev.Lett.* **55** (1986) 1958;
 - N. Christ and A. Terrano, *Phys.Rev.Lett.* **56** (1986) 111.
- [20] W. Langguth, I. Montvey and P. Weisz, *Nucl.Phys.* **B277** (1986) 11;
 - J. Jersak, C.B. Lang, T. Neuhaus and G. Jones, *Phys.Rev.* **D32** (1985) 2761.

- [21] V.P. Gerdt, A.S. Ilchev, V.K. Mitryushkin, I.K. Sololev and A.M. Zadorozhny, Nucl.Phys. **B265** (1986) 145.
- [22-23] R.D. Pisarski and F. Wilczek, Phys.Rev. **D29** (1984) 338;
 - R. Gupta, G. Guralnik, G.W. Kelcup, A. Patel and S.R. Sharpe, Phys.Rev.Lett. **57** (1986) 2621;
 - J.B. Kogut and D.K. Sinclair, ILL-TH-86-46;
 - J.B. Kogut, H.W. Wyld, F. Karsch and D.K. Sinclair, ILL-TH-87-6;
 - E. Laermann, F. Langhammer, I. Schmitt and P.M. Zerwas, Phys. Lett. **173B** (1987) 443.
- [24] J. Kogut, J. Shigemitsu and D.K. Sinclair, Phys.Lett. **138B** (1984) 283;
 - J. Kogut: "Five Lite, Late-Summer Lecture on Lattices". ILL-TH-86-55.
- [25] B. Lautrup and M. Nauenberg, Phys.Lett. **95B** (1980) 63;
 H.G. Evertz, J. Jersak, T. Neuhaus and P.M. Zerwas, Nucl.Phys. **B251** [FS13] (1985) 279.
- [26] S. Itoh, Y. Iwasaki and T. Yoshié: "Scaling and Universality for the String Tension in Lattice QCD". UTHEP-154/86.
- [27] Gutbrot: "Departures from Scaling in SU(2) Lattice Gauge Theory. DESY-preprint 86-065.
- [28] M. Creutz, Phys.Rev.Lett. **45** (1980) 313;
 - M. Creutz and K.J.M. Moriarty, Phys.Rev. **D26** (1982) 2166.
- [29] M. Lüscher, Nucl.Phys. **B180** [FS2] (1981) 317.
- [30] J. Ambjørn, P. Olesen and C. Peterson, Nucl.Phys. **B244** (1984) 262.
- [31] M. Flensburg and A. Irbäck, Lund preprint (to appear).
- [32] J. Ambjørn and S.-K. Yang, Nucl.Phys. **B275** [FS17] (1986) 18.
- [33] J. Flower, S.W. Otto and S. Callahan, Phys.Rev. **D34** (1986) 598.

Received by Publishing Department
 on September 1, 1988.

ПЕРЕЧЕНЬ

лекция, вышедших с 1974 в ОИЯИ

- Фаустов Р.И. Связанная система частиц в квантовой электродинамике. Вып.1. ОИЯИ; Дубна, 1974.
- Синаев А.Н. Современные аппаратурные системы модульной структуры, используемые при создании измерительно-вычислительных комплексов /КАМАК, ВЕКТОР/. Вып.2. ОИЯИ, 8507, Дубна, 1975.
- Волков Д.В. Кварки как следствие дуальности. Вып.3. ОИЯИ, P2-8765, Дубна, 1975.
- Пальчик М.Я., Фрадки Е.С. Введение в теорию конформно-инвариантных квантовых полей. Вып.4. ОИЯИ, 2-8874, Дубна, 1975.
- Заморн Э. Микропроцессоры. Вып.5. ОИЯИ, P10-8852, Дубна, 1975.
- Виленькия С.М. Вопросы физики нейтрино высоких энергий. Вып.6. ОИЯИ, 2-9026, Дубна, 1975.
- Малкин И.А., Манько В.И. Инварианты, когерентные состояния и динамические симметрии квантовых систем. Вып.7. ОИЯИ, P2-9228, Дубна, 1975.
- Волков М.К., Первущин В.Н. Квантовая теория поля с киральным лагранжианом и физика мезонов низких энергий. Вып.8. ОИЯИ, P2-9390, Дубна, 1976.
- Василадзе С.Г. Интегральные схемы с эмиттерной связью и их применение в наносекундной ядерной электронике. Вып.9. ОИЯИ, 13-9744, Дубна, 1976.
- Анжики С.А. и др. Перенормированные составные поля в квантовой теории поля. Вып.10. ОИЯИ, P2-10528, Дубна, 1977.
- Шляпников П.В. Множественные процессы и инклюзивные реакции. Вып.11. ОИЯИ, P2-10681, Дубна, 1977.
- Капусцик Э. Галилеева инвариантность в теории поля. Вып.12. ОИЯИ, P2-10677, Дубна, 1977.
- Бутцев В.С. Явление возбуждения высокоспиновых ядерных состояний и механизм поглощения отрицательных π -мезонов. Вып.13. ОИЯИ, P15-10847, Дубна, 1977.
- Валуев В.Н. Применение алгебры Клиффорда к решению задачи Намига - Оноагера. Вып.14. ОИЯИ, P17-11020, Дубна, 1977.
- Капусцик Э. Нестандартные алгебры квантово-механических наблюдаемых. Вып.15. ОИЯИ, P4-11497, Дубна, 1978.

- Влохинцев Д.И. Квантовая механика. Лекции по избранным вопросам. Вып.16. ОИЯИ, P2-11728, Дубна, 1978.
- Шрикова Н.Ю. Начинанием работать на ЭВМ CDC-6500. Вып.17. ОИЯИ, P11-11739, Дубна, 1978.
- Барбашов В.М., Нестеренко В.В. Непрерывные симметрии в теории поля. Вып.18. ОИЯИ, P2-12029, Дубна, 1978.
- некоторые проблемы физики высоких энергий /сборник/. Вып.19. ОИЯИ, P2-12080, Дубна, 1978.
- Василадзе С.Г. Электронная регистрирующая аппаратура физического эксперимента. Вып.20. ОИЯИ, P13-12151, Дубна, 1979.
- Ефремов А.В., Радхшкин А.В. Партонь, жесткие процессы и квантовая хромодинамика. Вып.21. ОИЯИ, P2-12803, Дубна, 1979.
- Говорков А.В. Введение в теорию кварков. Вып.22, ОИЯИ, P2-12803, Дубна, 1979.
- Говорков А.В. Цветные кварки и глюоны. Вып.23. ОИЯИ, P2-80-6, Дубна, 1980.
- Исаев П.С. Глубоконеупругое рассеяние лептонов на нуклонах. Партонная модель нуклона. Вып.24. ОИЯИ, P2-80-325, Дубна, 1980.
- Казаков Д.И., Ширков Д.В. Суммирование асимптотических рядов в квантовой теории поля. Вып.25. ОИЯИ, P2-80-462, Дубна, 1980.
- Ососков Г.А. Применение методов распознавания образов в физике высоких энергий. Вып.26. ОИЯИ, P10-83-187, Дубна, 1983.
- Мальшев В.А. Элементарное введение в математическую физику бесконечно-частичных систем. Вып.27. ОИЯИ, P17-83-363, Дубна, 1983.
- Савушкин Л.И., Фоменко В.Н. Введение в мезонную теорию ядерных взаимодействий и ядерных систем. Вып.28. ОИЯИ, P4-83-369, Дубна, 1983.
- Виленький С.М. Осцилляции нейтрино. Вып.29. ОИЯИ, P2-83-441, Дубна, 1983.
- Бужек В. Введение в метод стохастического квантования. Вып.30. ОИЯИ, P2-84-419, Дубна, 1984.
- Шумовский А.С., Чукалов В.И. Фазовые состояния и переходы. Вып.31. ОИЯИ, P17-85-676, Дубна, 1985.
- Владимиров А.А. Введение в квантовые интегрируемые системы. Метод R -матрицы. Вып.32. ОИЯИ, P17-85-742, Дубна, 1985.
- Осипов В.А., Федякин В.К. Полиацетилен и двумерные модели квантовой теории поля. Вып. 33. ОИЯИ, P17-85-809, Дубна, 1985.

- Шуля Ш. Стохастичность в динамических системах. Вып. 34. ОИЯИ, Р17-86-211, Дубна, 1986.
- Ефремов А.В. Введение в квантовую хромодинамику. Вып. 35. ОИЯИ, Р2-86-212, Дубна, 1986.
- Нестеренко В.В., Червяков А.М. Сингулярные лагранжианы. Классическая динамика и квантование. Вып. 36. ОИЯИ, Р2-86-323, Дубна, 1986.
- Пепёльшев Д.Н. Регистрация нейтронов /современное состояние и перспективы развития/ Вып. 37. ОИЯИ, Р13-86-719, Дубна, 1986.
- Боголюбов Н.Н./мл./, Шумовский А.С. Светоизлучение. Вып. 38. ОИЯИ, Р17-87-176, Дубна, 1987.
- Пушкаров Д.И. Дефекты в кристаллах. /Метод квазичастиц в квантовой теории дефектов/. Вып. 39. ОИЯИ, Р17-87-177, Дубна, 1987.
- Никитяк И.М. От современной алгебры к специализированным процессорам. Вып. 40. ОИЯИ, Р10-87-401, Дубна, 1987.
- Дубиничкова А.З. Непрерывные группы для физиков. Вып. 41, ОИЯИ, Р2-87-197, Дубна, 1987.
- Никитяк И.М. Электронные методы экспериментальной физики высоких энергий. Вып. 42, ОИЯИ, Р1-87-909, Дубна, 1987.
- Балдин А.М., Диденко Л.А. Асимптотические свойства адронной материи в пространстве четырехмерных относительных скоростей. Вып. 43, ОИЯИ, Р1-87-912, Дубна, 1987.
- Машкевич В.С. Индетерминистская квантовая динамика. Вып. 44, ОИЯИ, Р2-88-150, 1988.
- Филиппов А.Т. Введение в теорию суперструн. Вып. 45, ОИЯИ, Р2-88-188, 1988.
- Бардин Д.Ю. Прецизионные проверки стандартной теории. Вып. 46, ОИЯИ, Р2-88-189. 1988.
- Смирнов В.А., Четыркин К.Г. R^* -операция: техника ренормгрупповых вычислений и другие приложения. Вып. 47, ОИЯИ, Р2-88-190, 1988.
- Добролюбов И.И., Игнатьев А.Ю., Шапошников М.Е. Элементарные частицы и космология. Вып. 48, ОИЯИ, Р2-88-654, 1988.

Требования, предъявляемые к серии брошюр
"Лекции для молодых ученых ОИЯИ"

Серия брошюр "Лекции для молодых ученых ОИЯИ" издаётся с целью повышения научно-профессионального кругозора и уровня молодых ученых и специалистов ОИЯИ в актуальных областях исследований, ведущихся по тематике Института. Выпуски должны представлять собой законченные циклы лекций, прочитанные в ОИЯИ и ориентированные прежде всего на молодых сотрудников Института.

Лекции должны иметь характер учебного пособия, предназначенного для первого ознакомления с рассматриваемой проблемой, а также содержать обзор её современного состояния. Они должны быть снабжены подробным оглавлением и основной литературой. Большие параграфы рекомендуются разбивать на подпараграфы с вынесенными в оглавление подзаголовками.

Весь текст, включая отдельные главы и параграфы, следует печатать, заполняя каждую страницу целиком.

Рукопись должна быть напечатана на специальных бланках, предназначенных для прямого репродуцирования, которые можно получать в издательском отделе. Все формулы и схемы должны быть вписаны аккуратно и ясно тушью или чернилами черного цвета. Разметка формул не производится, их нумерация должна находиться в конце строки справа в круглых скобках. Текст лекций печатается на машинке с черной (не серой) лентой через 1,5 интервала. Объем лекций не должен превышать 100 страниц машинописного текста.

Рукопись представляется в Редакционный совет серии брошюр "Лекции для молодых ученых ОИЯИ" Советом молодых ученых и специалистов ОИЯИ и Советами молодых ученых и специалистов лабораторий Института. Редакционный совет принимает окончательное решение о целесообразности ее публикации.

Редакционный совет

2 коп.

Редактор Э.В.Ивашкевич. Макет Р.Д.Фоминой.

Подписано в печать 09.12.88.

Формат 60x90/16. Офсетная печать. Уч.-изд.листов 3,48.

Тираж 250. Заказ 41386.

**Издательский отдел Объединенного института ядерных исследований.
Дубна Московской области.**