

IMPEDANCE CALCULATIONS FOR 2-D AND 3-D STRUCTURES AND THE IMPEDANCE BUDGET OF 7-GeV APS STORAGE RING*

W. Chou and Y. Jin**
Argonne National Laboratory
9700 S. Cass Avenue
Argonne, IL 60439 USA

The submitted manuscript has been authored by a contractor of the U. S. Government under contract No. W-31-109-ENG-38. Accordingly, the U. S. Government retains a nonexclusive, royalty-free license to publish or reproduce the published form of this contribution, or allow others to do so, for U. S. Government purposes.

NOV 03 1989

Abstract

For the storage ring of the 7-GeV Advanced Photon Source (APS), we numerically calculate the longitudinal and the transverse coupling impedances of various kinds of two- and three-dimensional structures. It is shown that the RF cavities are the main contributors to the longitudinal impedance, whereas the transitions between the chamber and the insertion device section dominate the transverse one. Several different numerical approaches are adopted. It is argued that the broadband resonator model may not be appropriate to model the longitudinal impedance. Several interesting phenomena of general interest, including a composition rule and the negative transverse impedance, are discussed. Based on our numerical results and other results available, the impedance budget of the storage ring is established.

Introduction

The impedances experienced by a particle beam that circulates in the APS storage ring play an essential role in the studies of the beam instability problem. Due to a large variety of structures in the ring, the computation of these parameters are tackled numerically by invoking the codes MAFIA and TBCI, both developed mainly at DESY.¹ For a given geometry [e.g., the RF cavities, the elliptic beam chamber with an antechamber, the crotch absorbers, the bellows with sliding shields, the valves, the full-penetration weldments, the transitions between the chamber and the insertion device (ID) section, and that between the chamber and the RF section, etc.], either MAFIA or TBCI computes the wake potentials generated by a Gaussian-distributed rigid bunch that is traversing the structure. These wake potentials are then converted to the impedances in two different ways. One is by a fast Fourier transform (FFT), which gives the impedance spectra up to certain critical frequencies. Another approach involves a fitting procedure. One first integrates the wakes to get the loss factor k and then, by repeating this process a few times for different bunch lengths, obtains the functional relationship $k(\sigma)$. Then one fits from the curve $k(\sigma)$ the parameters of a broadband resonator model. Figure 1 shows some examples of the 3-D geometries that have been studied in our computer simulations.

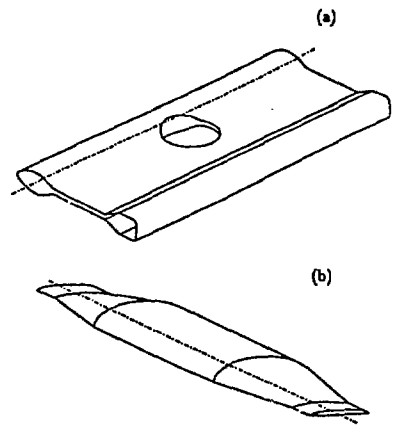

Fig. 1. Examples of the geometries studied in the computer simulations: (a) A beam chamber with an antechamber and a crotch absorber. (b) A transition between the chamber and the ID section, both of an elliptic cross section (one half of the structure).

A Composition Rule

A composition rule, which we observed in our calculations, has largely simplified our work in several cases. It can be stated as follows: one may decompose a complicated structure into simple components and compose these components to form new structures. Under certain conditions, the old and the new structures will give the same impedance. Figure 2 shows an example for demonstrating the application of this rule. For more details the reader is referred to Ref. 2.

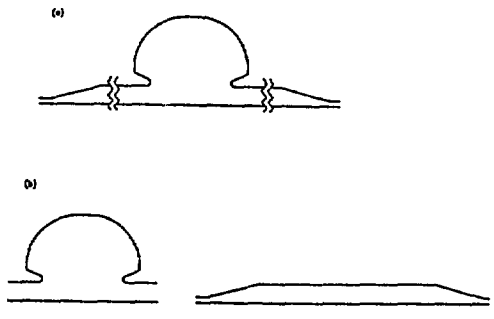

Fig. 2. (a) A complex structure, consisting of an RF cavity and two tapered parts, is decomposed to three components. (b) These components are then recomposed to form two new structures. Both (a) and (b) give the same impedance, while (b) is easy to compute.

*This research was supported by the U.S. Department of Energy, Office of Basic Energy Sciences, under Contract W-31-109-ENG-38.

**Present Address: Hefei National Synchrotron Radiation Laboratory, University of Science and Technology of China, Hefei, The People's Republic of China.

DISCLAIMER

This report was prepared as an account of work sponsored by an agency of the United States Government. Neither the United States Government nor any agency thereof, nor any of their employees, makes any warranty, express or implied, or assumes any legal liability or responsibility for the accuracy, completeness, or usefulness of any information, apparatus, product, or process disclosed, or represents that its use would not infringe privately owned rights. Reference herein to any specific commercial product, process, or service by trade name, trademark, manufacturer, or otherwise does not necessarily constitute or imply its endorsement, recommendation, or favoring by the United States Government or any agency thereof. The views and opinions of authors expressed herein do not necessarily state or reflect those of the United States Government or any agency thereof.

An interesting phenomenon, the negative transverse impedance, has been noticed in our simulations. It is known that, for a rotationally symmetric geometry, the transverse wake potential has a positive first peak and, accordingly, the transverse loss factor is positive.³ However, when this rotational symmetry is broken, the first peak could become a negative one and the loss factor also negative, as we find in our 3-D simulations.⁴ Figure 3 illustrates a structure modeling some special chambers in SPS at CERN. It consists of a circular cavity and two rectangular side beam pipes. Figure 4 shows the first peak of the horizontal wake potential as a function of x , the half-width of the horizontal side of the rectangular cross-section. When x increases, the first peak exhibits a smooth transition from a positive value to zero, and then to a negative one. Figure 5 is an example of a negative first peak of the horizontal wake potential. A similar transition is seen for the horizontal loss factor. These results are in agreement with that obtained recently from the tune shift measurements in SPS, which indicate that the horizontal and the vertical impedances of SPS have opposite signs.⁵

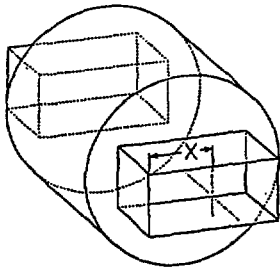

Fig. 3. The geometry that exhibits a negative horizontal impedance.

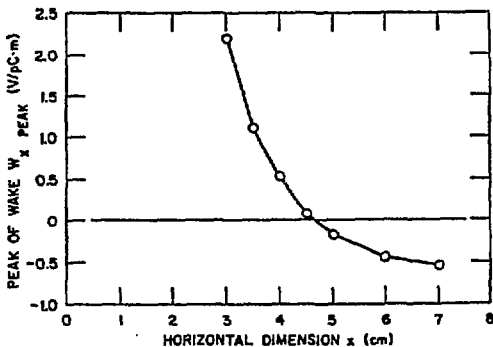

Fig. 4. A smooth transition from positiveness to negativeness of the first peak of the horizontal wake potential.

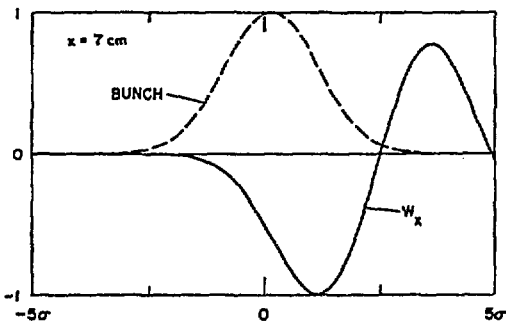

Fig. 5. An example of a negative first peak of the horizontal wake potential.

The wake potentials computed by MAFIA and TBCI can be converted to impedance spectra through an FFT. The impedances obtained in this manner are associated with a rigid bunch of a finite length. In order to get the impedance seen by a point charge, one should deconvolute the FFT results. This process will lead to information loss. To minimize this effect, a short bunch is preferred. But this is usually limited by the capability of the available computer systems. In most of our MAFIA simulations, the bunch length is chosen to be 1.75 cm, about three times its zero-current value. The meaningful spectra have an upper bound of 8 GHz and a resolution of 0.17 GHz. In TBCI simulations, the bunch length can be much shorter and, accordingly, the upper bound of the spectra much higher. As an example, Fig. 6 shows the longitudinal wake potentials and the real and imaginary parts of the impedance spectra for an RF cavity. A detailed discussion on the FFT method can be found in Refs. 6 and 7.

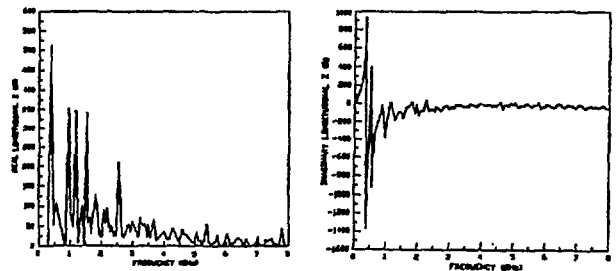
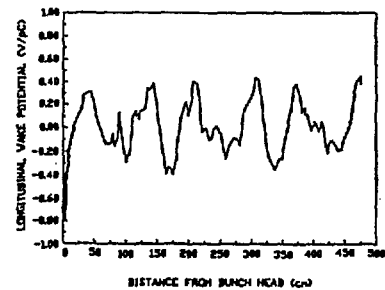

Fig. 6. Examples of the wake potentials and the impedance spectra (for an RF cavity).

Fitting Technique

Assuming that the impedance of a structure may be approximately described by a broadband resonator model, the parameters R , Q , and f_x can then be determined by the functional curve $k(\sigma)$, the loss vs. bunch length. Figure 7 shows the curves of some components in the APS storage ring, computed by TBCI. Figure 8 shows the loss curves of a broadband resonator in normalized units. Our goal is to use some curve in Fig. 8 to fit a given curve in Fig. 7. We have tried two different techniques to fit these curves. One is the least-squares fit. Another is suggested in Ref. 8, which works in the transverse case. The results show that, while the broadband resonator is appropriate for modeling the transverse impedance, it falls in the longitudinal case. The Q values obtained from fitting the longitudinal $k(\sigma)$ curves are so small (0.1 or even 0.0004!) that they could not be physically meaningful. A better model needs to be developed.

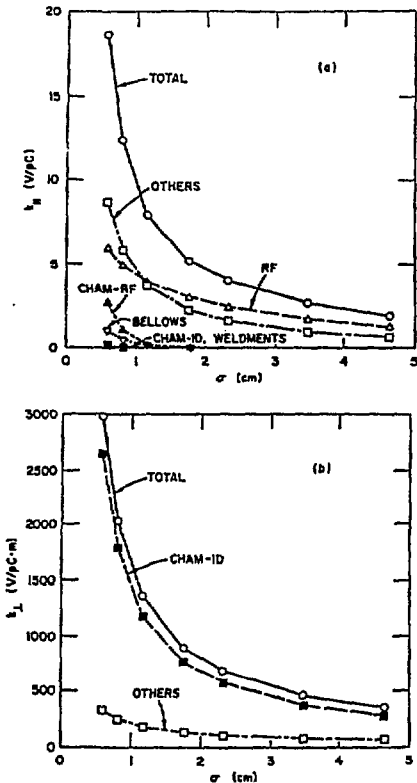

Fig. 7. Examples of the $k(\sigma)$ curves: (a) longitudinal. (b) transverse.

APS Impedance Budget

The numerical approaches described above have been applied to various kinds of 2-D and 3-D structures in the APS storage ring. Some components, however, are not numerically calculable, either because the structures are too complicated (such as the screened ion pump ports) or because they have not yet been designed in full detail (such as the injection and abort sections and many diagnostic instruments). The losses of these parts are estimated by using PEP-measured data.⁹ For simple cases, on the other hand, including the resistive wall, the space charge, and the button-type BPMs, the impedances can easily be calculated using available formulae.⁶ Based on the results obtained from all these approaches, the impedance budget for the APS storage ring is established and listed in Table I. The total calculated values are the summation of that of each individual component. As a conservative measure, the budget is twice as big as the calculated values. This table has been used in our studies on beam instabilities. It should be pointed out that, among those data obtained from numerical simulations, the largest longitudinal impedance is contributed by the RF cavities (about 50%), whereas the largest transverse impedance comes

Table I
APS Impedance Budget

	Calculated	Budget
Longitudinal $Z_{ }/n$ (Ω)	1	2
Transverse Z_{\perp} (M Ω /m)	0.35	0.7

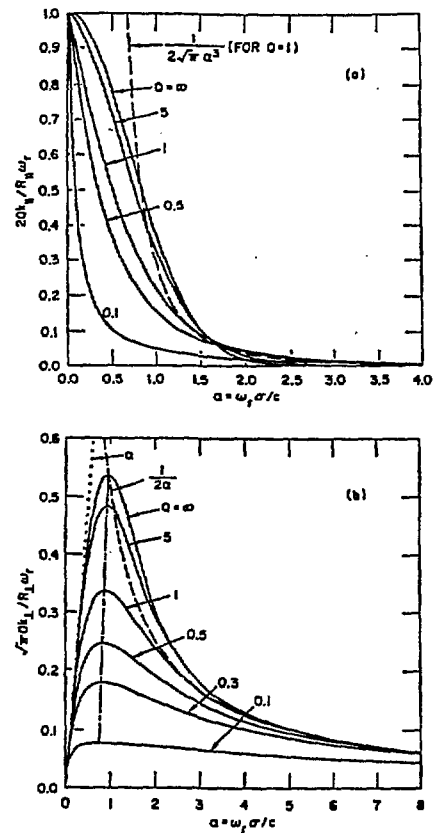

Fig. 8. Loss factors as a function of bunch lengths for a broad band resonator in normalized units: (a) longitudinal. (b) transverse.

from the transitions between the chamber and the ID section (more than 80%). The vertical dimension of the ID section is the most critical parameter, insofar as the transverse impedance is concerned. The vertical impedance would be reduced to half its current value if the vertical size of the ID section were increased from 8 mm (current design) to 12 mm.

References

1. T. Weiland, IEEE Trans. Nucl. Sci., NS-32, 2738 (1985).
2. W. Chou and Y. Jin, Argonne National Laboratory, Light Source Note LS-112 (1988).
3. A. W. Chao, SLAC-PUB-2946 (June 1982).
4. W. Chou and Y. Jin, Argonne National Laboratory, Light Source Note LS-114 (1988); W. Chou, in preparation.
5. D. Brandt et al., SPS/AMS/Note/88-14 (Dec. 14, 1988).
6. W. Chou and Y. Jin, Argonne National Laboratory, Light Source Note LS-115 (1988).
7. W. Chou and E. Crosbie, "Proceedings of Impedance and Current Limitations Workshop," ESRF, Grenoble, France (Oct. 17-18, 1988).
8. B. Zotter, CERN LEP-TH/87-34 (1987).
9. J. N. Weaver, P. B. Wilson, and J. B. Styles, IEEE Trans. Nucl. Sci., NS-26, 3971 (1979).