

LAMP/92/5

**INTERNATIONAL CENTRE FOR
THEORETICAL PHYSICS**

**LAMP
SERIES REPORT**

(Laser, Atomic and Molecular Physics)

**IONIC CLASSIFICATION OF XE LASER LINES:
A NEW APPROACH THROUGH TIME RESOLVED
SPECTROSCOPY**

D. Schinca

R. Duchowicz

and

M. Gallardo

MIRAMARE-TRIESTE



**INTERNATIONAL
ATOMIC ENERGY
AGENCY**



**UNITED NATIONS
EDUCATIONAL,
SCIENTIFIC
AND CULTURAL
ORGANIZATION**

International Atomic Energy Agency
and
United Nations Educational Scientific and Cultural Organization
INTERNATIONAL CENTRE FOR THEORETICAL PHYSICS

**LAMP
SERIES REPORT**
(Laser, Atomic and Molecular Physics)

ABSTRACT.

Visible and UV laser emission from a highly ionized pulsed Xe plasma was studied in relation to the ionic assignment of the laser lines. Time-resolved spectroscopy was used to determine the ionic origin of the studied lines. The results are in agreement with an intensity versus pressure analysis performed over the same wavelength range. From the temporal behaviour of the spontaneous emission, a probable classification can be obtained.

**IONIC CLASSIFICATION OF XE LASER LINES:
A NEW APPROACH THROUGH TIME RESOLVED SPECTROSCOPY**

D. Schinca *, R. Duchowicz **

International Centre for Theoretical Physics, Trieste, Italy
and

Centro de Investigaciones Opticas, c.c.124 (1900) La Plata, Argentina

and

M. Gallardo ***

Centro de Investigaciones Opticas, c.c.124 (1900) La Plata, Argentina.

MIRAMARE – TRIESTE

December 1992

* Member of the Research Career of CICPBA, Argentina and Assistant Professor at Dto. de Fisica, Universidad Nacional de La Plata, Argentina.

** Member of the Research Career of CONICET, Argentina and Assistant Professor at Dto. de Fisica, Universidad Nacional de La Plata, Argentina.

*** Member of the Research Career of CONICET, Argentina.

INTRODUCTION

Ionic Xe can be made to lase in a pulsed regime in several lines ranging from about 250 to 600 nm [1-3], where it delivers the largest power per pulse compared with other noble gas lasers. Peak powers of up to 80 kW (FWHM, all lines) in 300 ns. and even 300W (FWHM, all lines) in 100 μ s. have been reported. This laser is effectively used as pump source for dye and colour centre lasers, in semiconductor processing and for teaching purposes.

Both from a basic and a practical point of view, it is important to know which is the ionic species responsible for laser action. In the early seventies, studies on pulsed Xe discharges were carried out in several laboratories, in which the main visible laser lines were assumed to correspond to the spectrum of triply ionized xenon (Xe IV) [4-6]. However, later spectroscopic work related with the determination of the energy level structure corresponding to the lower configurations of that ion, could not account for the laser lines, since they did not fit into the proposed Xe IV transition scheme [7]. Neither they could be fitted into the Xe II or Xe III structure. In cases where this structure is almost or completely unknown, the assignment is currently carried out through an analysis of the intensity of the emitted lines as a function of the mean energy of the electrons in the discharge, based on the observed fact that as this energy is increased, higher ionic species tend to appear. Figure 1 shows a partial spectrogram of the spontaneous emission of ionic Xe in the UV region.

Here we report on the use of time-resolved spectroscopy for ionic line assignment in a pulsed Xe plasma. Although the aim of this work is the study of the laser lines, it can also be applied to any spontaneous emission line.

EXPERIMENTAL SETUP

Figure 2 sketches the experimental arrangement. The discharge tube was made of Pyrex glass, 1 m long and 5 mm internal bore, with indium coated tungsten electrodes placed in side-arms. The tube was connected to a vacuum line and to a Xe reservoir (spectroscopically pure) so that the discharge channel could be thoroughly evacuated and filled with a suitable pressure of Xe. The latter could be varied in small steps between 5 and 300 mTorr. The gas was excited by discharging across the tube a 140nF capacitor charged at 12kV through a pressured spark-gap. Peak currents of 3kA were typically obtained.

The resonator consisted in two concave dielectric-coated mirrors placed in a near confocal configuration. These could be readily removed when performing spontaneous emission spectroscopy. The outgoing radiation could be focused either onto a grating spectrograph of moderate resolution (for frequency-resolved spectroscopy) or onto a monochromator-photomultiplier system of 5ns. resolution (for time-resolved spectroscopy). The latter was in turn connected to a digital oscilloscope and to a plotter. Finally, the current was monitored using a Rogowsky coil and it was used to trigger the oscilloscope.

RESULTS AND DISCUSSIONS.

A section of the spectra of the spontaneous emission from the Xe discharge is shown in figure 1. Since the mean energy of the electrons in the discharge is governed by the ratio E/p (electric field inside the tube over pressure in the vessel), a change in any of these two quantities would produce a change in the electron energy and consequently, a change in the appearance of different ionic species. In the case shown in figure 1, spectra for different pressure values at constant discharge voltage were

recorded. Inspection of the behaviour of the intensity of the lines with pressure suggest a preliminary assignment, which must be compared with the behaviour of known lines. It is an established method which gives reasonable results, although it has the drawback of presenting saturation effects, inherent of photographic recording methods.

In time-resolved spectroscopy, the monochromator scans individual lines over the whole wavelength range of interest and the temporal behaviour is displayed on the oscilloscope. A typical example is shown in figure 3, together with the current pulse for reference. The transition corresponds to the 4954.13 Å line, which is shown in its stimulated and spontaneous emissions. Notice the narrower width of the laser emission due to gain depletion and its centering in the spontaneous emission maximum. Notice also that both emissions present a time delay with respect to current, the larger one corresponding to the laser due to the necessity of overcoming the losses in the cavity. In the following we shall concentrate on the time analysis of spontaneous emission.

It was observed that, all lines studied in the wavelength range of interest, presented a typical behaviour corresponding to the different stages of ionization. In fact, we noticed that the lines could be grouped together according to their time-intensity distribution, and these groups were coincident with the three studied ionization stages. An example of this is shown in figure 4. In part (a) we show the typical behaviour of Xe II lines, together with the current pulse used as reference. The pressure was fixed at 5 mTorr in all cases. It can be seen that, apart from an intensity factor, they all show identical behaviour, following the rise of the current pulse and a clear structure in the negative overshoot of the latter. The characteristic behaviour of all Xe III lines is shown in part (b), where only two lines of this ion are displayed as an example. It can be seen that they show a positive delay with respect to current and less structure in the overshoot. Correspondingly, similar results were observed for the Xe IV lines

studied in the wavelength range: they all showed a larger delay and a characteristic internal structure. All these facts suggest that lines belonging to the same ion behave alike, and that the temporal features of a line could be used to determine its ionic origin.

When the visible laser lines were monitored, it was observed that they presented their own characteristic features (figure 4(c)), different from those corresponding to Xe II, Xe III or Xe IV lines, thus suggesting that they belong to higher ions.

It is observed that the general temporal features of the lines vary with pressure, a fact to be expected if we bear in mind that the population mechanisms depend on electron energy and thus on the mean free path. Although the lines tend to get broader and to have larger delays as the pressure is increased, the distinct temporal behaviour of lines belonging to different ions is preserved. An example of this is shown in figure 5, where different laser lines are displayed for a pressure of 38 mTorr. Although this value is nearly 8 times the one of figure 4, all lines still show identical distribution (apart from an intensity factor).

Another fact that was observed was the correspondence between the onset of spontaneous emission (time-delay) and the ionization stage. By analyzing this feature for many lines of known assignment, it can be established that low ionic species are the first to appear (they have the shortest time-delays). Figure 6 illustrates this fact. When the laser lines are monitored, they show a delay larger than the one which is typical of Xe IV lines. Since we found no other line pattern falling in between those corresponding to consecutive ionic stages and bearing in mind that lines from the same ion behave alike, we can assign the laser lines to Xe V.

Complementing the previous analysis, figure 7 shows a normalized plot of intensity vs. pressure of lines corresponding to consecutive ions, taken directly from the photomultiplier stage. As the pressure decreases (mean electron energy increases), lines from higher ionic species appear and coincide with the ones that

show the largest delay in the time-resolved experiments. Thus, by using the latter method and complementing it with an intensity-pressure analysis we were able to classify most of the Xe laser lines as to Xe V, with high accuracy. Table I summarizes the results and shows a comparison with previous works. The differences in assignment are due to the little knowledge about Xe IV structure available at that time.

SUMMARY AND CONCLUSIONS.

We have used time-resolved spectroscopy analysis for ionic assignment of emission lines in a pulsed Xe plasma. It has been observed that lines belonging to the same ionic species share a common temporal behaviour (delay with respect to the current pulse and intrinsic temporal distribution). It has been shown, in particular, that a clear correspondence can be established between temporal delay and degree of ionization. All these features are characteristic of each species, and may be effectively used to distinguish lines belonging to different ions.

A systematic analysis of the different reported Xe lasers lines (both in the UV and visible range) using this alternative method and complementing it with an intensity-pressure study of the lines, enabled us to unambiguously assign most of the laser lines to Xe V instead of Xe IV, as they were previously classified. As the method is based on the analysis of several features, it imposes stringent conditions for a line to be accurately classified.

ACKNOWLEDGEMENTS.

Two of us (D.S. and R.D) would like to thank the International Centre for Theoretical Physics, the Atomic Energy Agency, UNESCO, and particularly to Prof. G. Denardo for the opportunity of participating in ICTP courses and for the hospitality received at that Centre.

REFERENCES

1. J.B. Marling, "Ultraviolet ion laser performance and spectroscopy. Part I: New strong noble-gas transitions below 2500 Å". IEEE J. Quantum Electron. vol. QE 11, pp. 822-824, 1975.
2. A. Papayoanu, R.G. Buser and J.M. Gumeiner, "Parameters in a dynamically compressed xenon plasma laser". IEEE J. Quantum Electron. vol. QE-9, pp. 580-585, 1973.
3. M. Gallardo, F. Bredice, M. Raineri and J. Reyna Almandos. "A light source for obtaining spectra of highly ionized gases", Appl. Opt. vol. 28, pp. 4513-4515, 1989.
4. E. Gallego Llesma, A.A. Tagliaferri, C.A. Massone, M. Garavaglia and M. Gallardo, "Ionic assignment of unidentified xenon laser lines" J. Opt. Soc. Am. vol. 63, pp. 362-364, 1973.
5. V. Hoffmann and P.E. Toschek, "On the ionic assignment of xenon laser lines", J. Opt. Soc. Am. vol. 66, pp. 152-154, 1976.
6. W.R. Bennett Jr., "Atomic Gas Laser Transition Data". IFI/Plenum, pp. 151-159, 1979.
7. J. Reyna Almandos, F. Bredice, M. Gallardo, C.J.B. Pagan, O. Di Rocco and A. Trigueiros, "5s 5p (5d+6s) configurations in triply ionized xenon", Phys. Rev. A vol. 43, pp. 6098-6103, 1991.

FIGURE CAPTIONS

Laser line (Å)	ion	Laser line (Å)	ion
2477.34	V	3973.01	V
2691.74	V	4305.69	V
3079.72	V	4954.13	V
3246.99	VII	5007.80	V
3305.96	V	5159.08	V
3330.84	V	5260.19	V
3483.25	V	5352.92	V
3645.48	VII	5394.62	V
3669.18	V	5955.67	V
3803.26	V		

Table I : Principal ionized Xe UV-visible laser lines. The list of wavelengths has been taken from reference [6].

Fig. 1 : Partial spectrogram of ionized Xe recorded for different pressure values. In this case, a 280 nF capacitor was used.

Fig. 2 : Experimental setup. HV : high voltage supply; RC : Rogowsky coil; F : filter; L : lens; PD : photodiode; PM : photomultiplier.

Fig. 3 : Temporal evolution of the 4954.13 Å line in its laser and spontaneous emissions.

Fig. 4 : Temporal evolution of ionic Xe lines for 5 mTorr pressure: (a) Xe II, (b) Xe III, (c) some lasing lines (L). A non-lasing line at 5374.97 Å is included for comparison.

Fig. 5 : Temporal waveform of lasing lines for a pressure of 38 mTorr.

Fig. 6 : Time delay for Xe lines of consecutive ionization stages. (L) stands for lasing line. Pressure is 5 mTorr

Fig. 7 : Intensity vs. pressure plot for Xe lines belonging to consecutive Xe ions. The labels on the curves correspond to the ionic stage, and the selected lines are : IV : 3310.40 Å, V : 5394.62 Å, VI : 3671.81 Å and VII : 3645.48 Å.

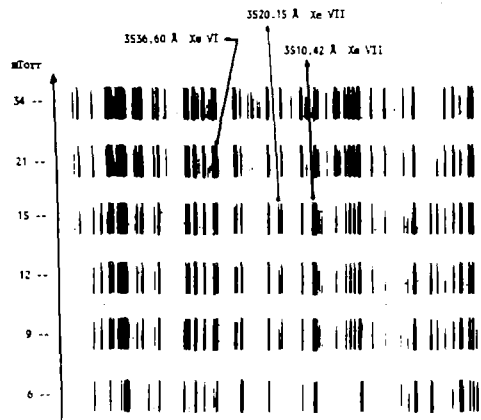

FIG. 1

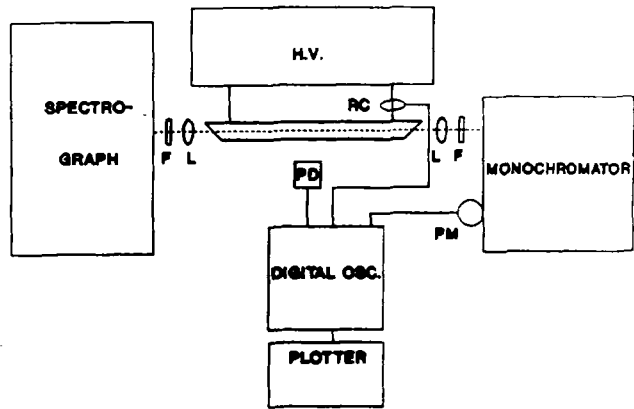

FIG. 2

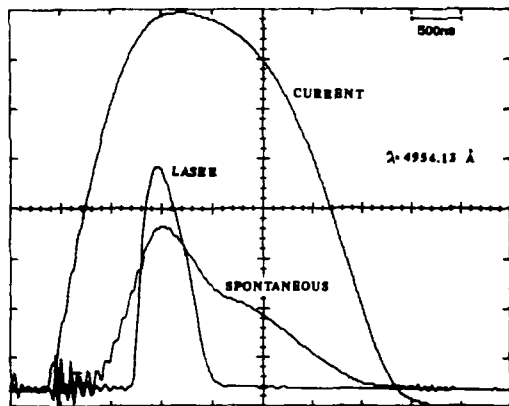

FIG. 3

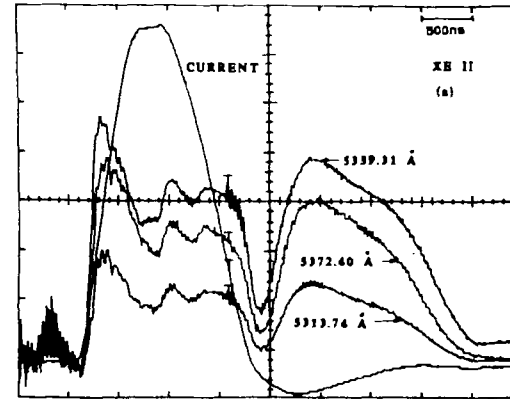

FIG. 4 (a)

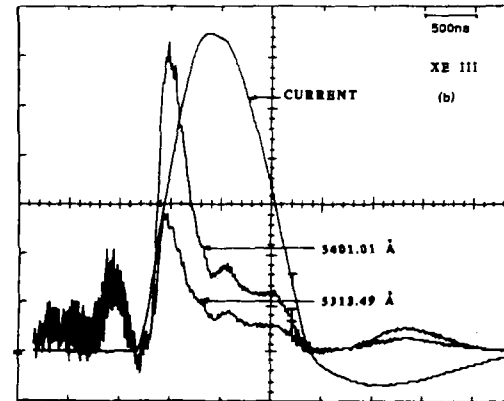

FIG. 4 (b)

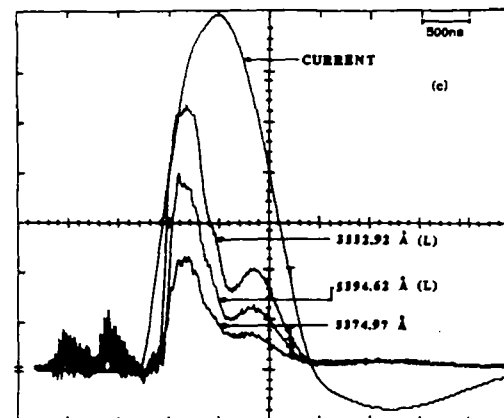

FIG. 4 (c)

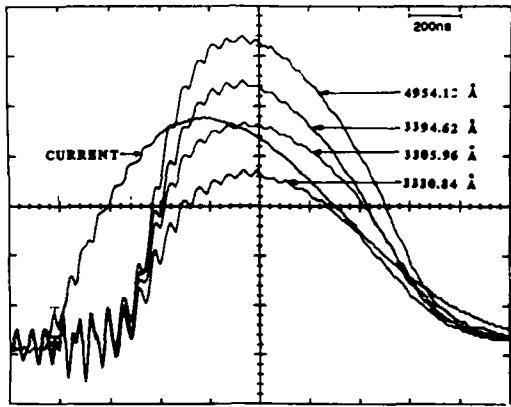

FIG. 5

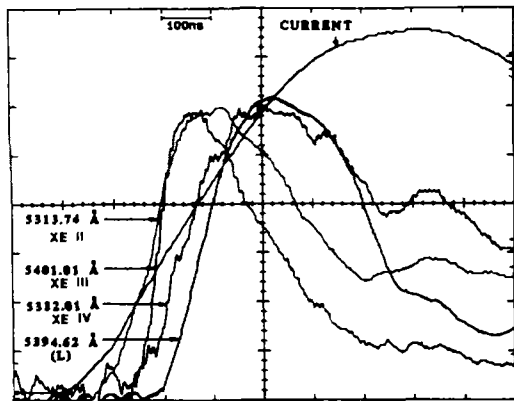

FIG. 6

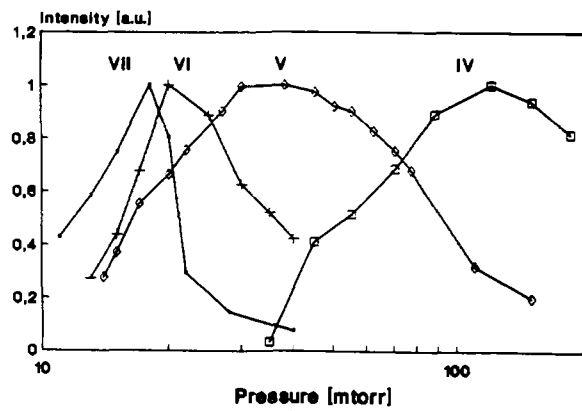

FIG. 7