

FR 930 2249

U.S. DEPARTMENT OF ENERGY
M282

**THERMAL STABILITY OF MORPHOLINE, AMP AND SARCOSINE IN PWR
SECONDARY SYSTEMS. LABORATORY AND LOOP EXPERIMENTS**

Damien FERON and Irma LAMBERT

Commissariat à l'Energie Atomique
Section d'Etude de la Corrosion Aqueuse
BP N°6, 92265 Fontenay aux Roses, France

**Second International Symposium
on Chemistry in High Temperature Aqueous Solutions
PROVO, UTAH, USA, 19-22 August 1991**

CC / 9629

SCECF
CICA

ABSTRACT

Laboratory and loop tests have been carried out in order to investigate the thermal stability of three amines (morpholine, AMP and sarcosine) in PWR secondary conditions. Laboratory experiments have been performed in a titanium autoclave at 300°C. The results pointed out high thermal decomposition rates of AMP and sarcosine. A decomposition mechanism is proposed for the 3 amines. Loop tests have been performed in order to compare steam cycle conditioning with ammonia, morpholine and AMP. The amine concentrations and the decomposition products such as acetate and formate have been followed around the secondary circuit of the ORION loop which reproduces the main physico-chemical characteristics of a PWR secondary circuit. These concentrations are reported together with the evolution of cationic conductivities. The influence of oxygen concentration on amine thermal stability has been observed. Results are expressed also in terms of decomposition rates and of relative volatility.

INTRODUCTION

Two-phase erosion-corrosion occurs in the steam-water circuits of some PWR plants, mainly when AVT (all volatile treatment) is used. This phenomenon is strongly dependent on pH. To get a sufficiently high pH in the water liquid phase where erosion-corrosion takes place, a high concentration of ammonia is needed, which is not compatible with copper alloy tubing of condensers. Therefore, the replacement of ammonia in the feedwater treatment by a basic amine with a partition coefficient near one offers advantages for controlling erosion-corrosion. Laboratory and loop tests have been carried out in order to investigate the thermal stability of two amines which may replace ammonia : morpholine and aminomethylpropanol (AMP).

In recirculating steam generators, degradations of alloy 600 tubing from secondary side may occur in flow restricted areas where contaminants, such as sodium hydroxide, can concentrate to weight percent concentrations and lead to tubing degradations such as stress corrosion cracking (SCC) or intergranular attack (IGA). Therefore, the addition of a buffering compound of low volatility in

the steam generator water could neutralize caustic in these crevices. Sarcosine has been selected as a possible buffer or IGA/SCC inhibitor. So, the thermal stability of sarcosine in PWR secondary conditions has to be investigated.

LABORATORY TESTS

Experimental

Laboratory tests have been performed in order to compare the decomposition rates, to determine the decomposition products, and to obtain information about the mechanism of the thermal decomposition of the different amines. Experimental devices used were, for the three amines, a titanium autoclave (figure 1), and, in addition, the vapor phase decomposition of AMP was studied in a once-through device (figure 2).

The solutions were prepared with pure chemicals and ultrapure water from a MILLIPORE purification device (milli-Q2). All the solutions were handled under an inert gas blanket, before and during the test.

The main analytical methods were the following :

- pH, conductivity and total acidity were measured on each sample taken from autoclave.
- Organic ions were analyzed by ionic chromatography.
- Except morpholine which was analyzed by colorimetry of the copper complex of thiocarbamate, this one being produced by reaction of CS₂ on morpholine.
- Ammonium was analyzed by specific electrode.
- Gas chromatography and mass spectrometry were used for non-ionic species analysis in liquid and vapor phases.

Morpholine O (CH₂ CH₂)₂ NH

Thermal decomposition was studied on dilute solutions (10⁻³, 10⁻⁴, 10⁻⁵ mol.kg⁻¹) by morpholine analysis after different times of thermolysis, and followed by the pH evolution.

Morpholine analysis did not allow determination of an order of reaction, probably because of the intervention of an heterogeneous decomposition on the walls of the autoclave. Nevertheless, morpholine appears relatively stable, 50 % decomposition appearing after more than three weeks.

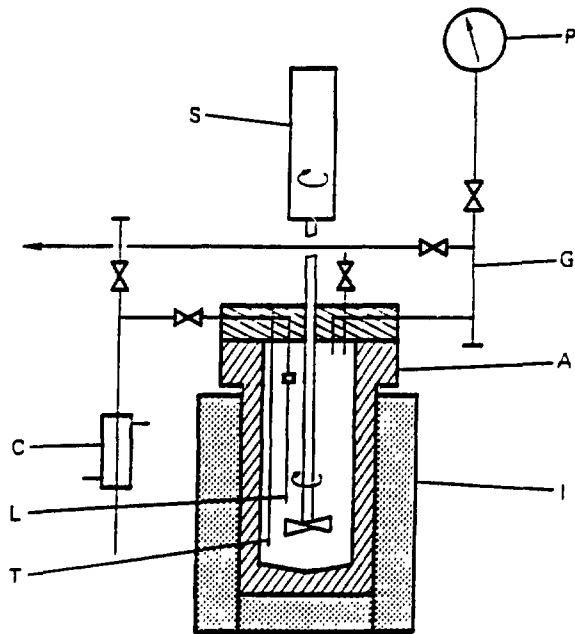

- A = titanium Autoclave
- C = Cooling
- L = Liquid sampling line
- G = Gas sampling line
- I = thermal insulation and electrical heaters
- P = Pressure
- S = Stirring device
- T = Thermocouple

Figure 1. Experimental device for laboratory tests

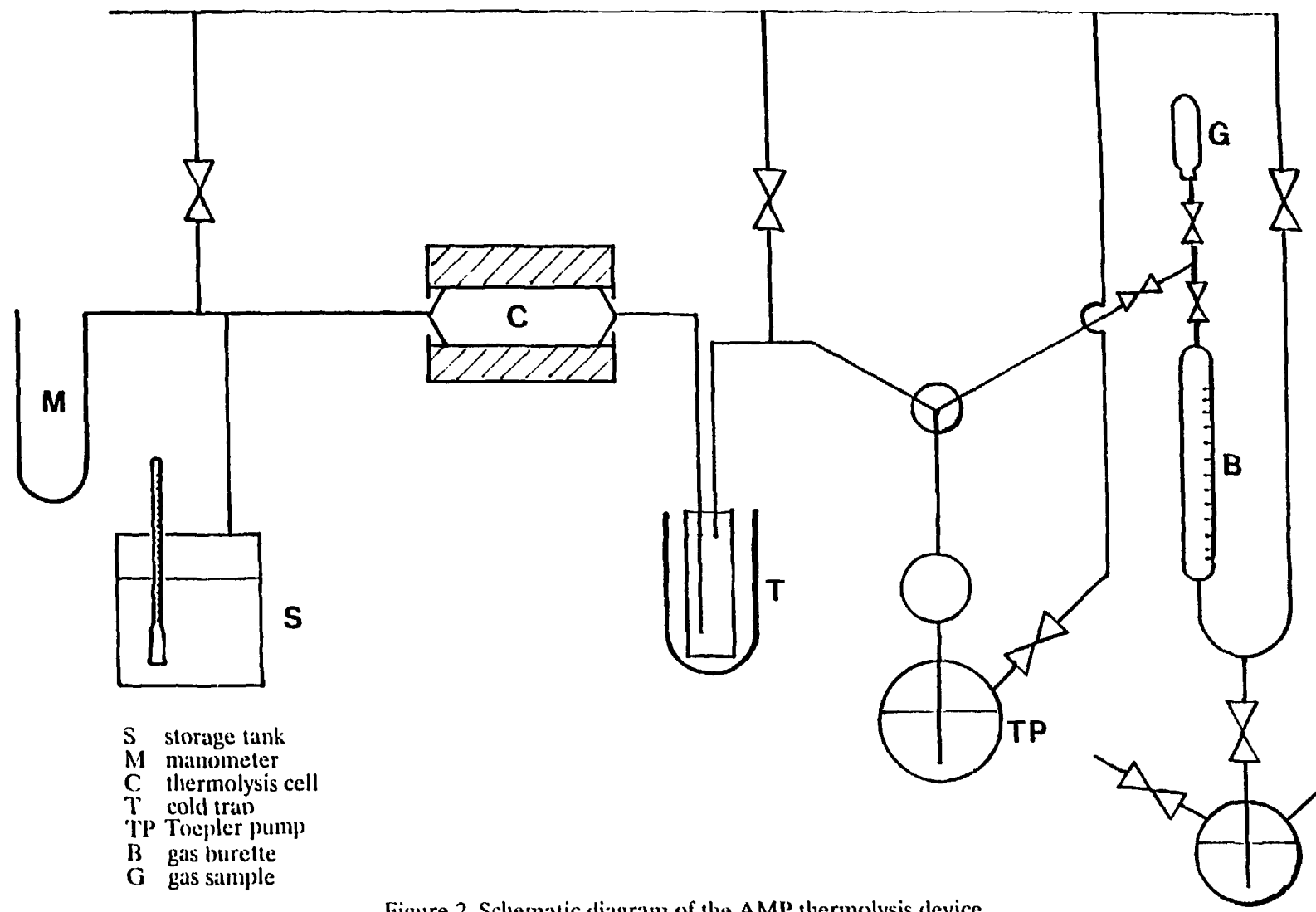

- S storage tank
- M manometer
- C thermolysis cell
- T cold trap
- TP Toepler pump
- B gas burette
- G gas sample

Figure 2. Schematic diagram of the AMP thermolysis device

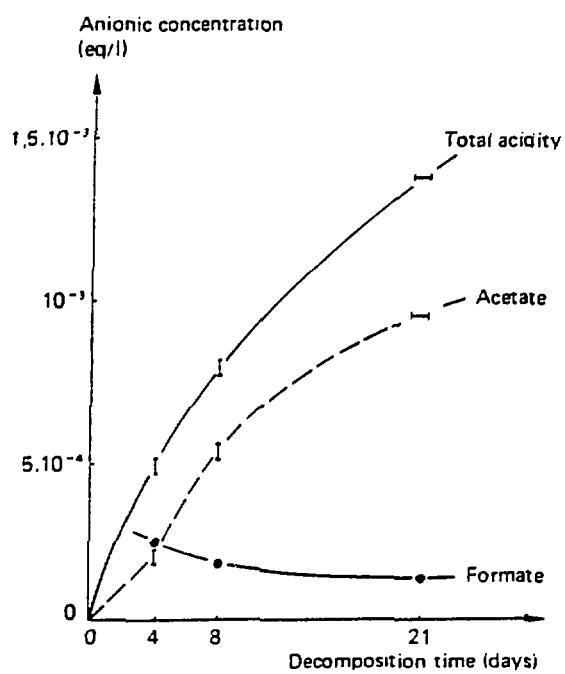

Figure 3. Evolution of the anionic decomposition products of a 0.01 M morpholine solution at 300°C

The pH remains stable during the decomposition.

On these solutions, mass spectrometry and gas chromatography showed evidence for ethanal, ethanol, glycol and monomethanolamine in the liquid phase, light hydrocarbons, H₂ and CO₂ in the gas phase.

A more concentrated solution of morpholine (0.01 M) was thermolysed in autoclave during 21 days at 300°C in order to allow ionic chromatography analysis : monomethanolamine, acetate and formate were indentified (figure 3).

The following mechanism [3,4] is compatible with these results :

Hydrolysis of morpholine forming glycol, mono- and diethanolamine :

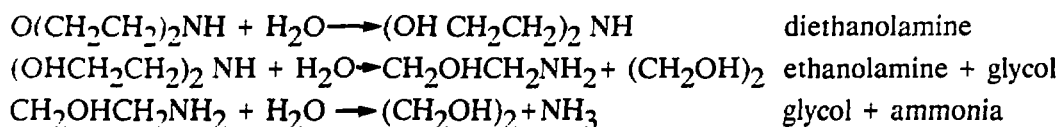

Oxidization of glycol by traces of oxygen or by water itself (as may be induced by the presence of hydrogen in gas phase), leads to organic acids (acetate and formate) and, finally, to CO₂.

Sarcosine CH₃ NH CH₂ COOH

Sarcosine thermal decomposition was followed on two solutions, 0.1 and 0.001 mol.kg⁻¹ respectively, and at two temperatures, 250 and 300°C, during 21 days.

Cationic decomposition products observed were ammonia, mono-, di- and tri-methylamine. Anions found were acetate and formate. Sarcosine itself was not analyzed.

The results show that, in all cases, after 48 hours, the sum of the concentrations of cationic decomposition products equals the initial concentration of sarcosine, showing that the decomposition was total. During the next days, concentration of ammonia grew at the expense of amine concentration, due to the thermal instability of mono and dimethylamine. Due to the thermal degradation of sarcosine to ammonia and more basic amines, an increase of the pH of the sarcosine solutions has been observed during the first 48 hours of the tests (from about 5.6 at the beginning to around 9.0 after 48 hours at 300°C for the 0.1 mol.kg⁻¹ solution).

Anions found were acetate and formate, at lower concentration.

Figure 4 shows the variation with time of the concentrations of the cationic decomposition products . The probable first steps of the thermal decomposition mechanism are the following :

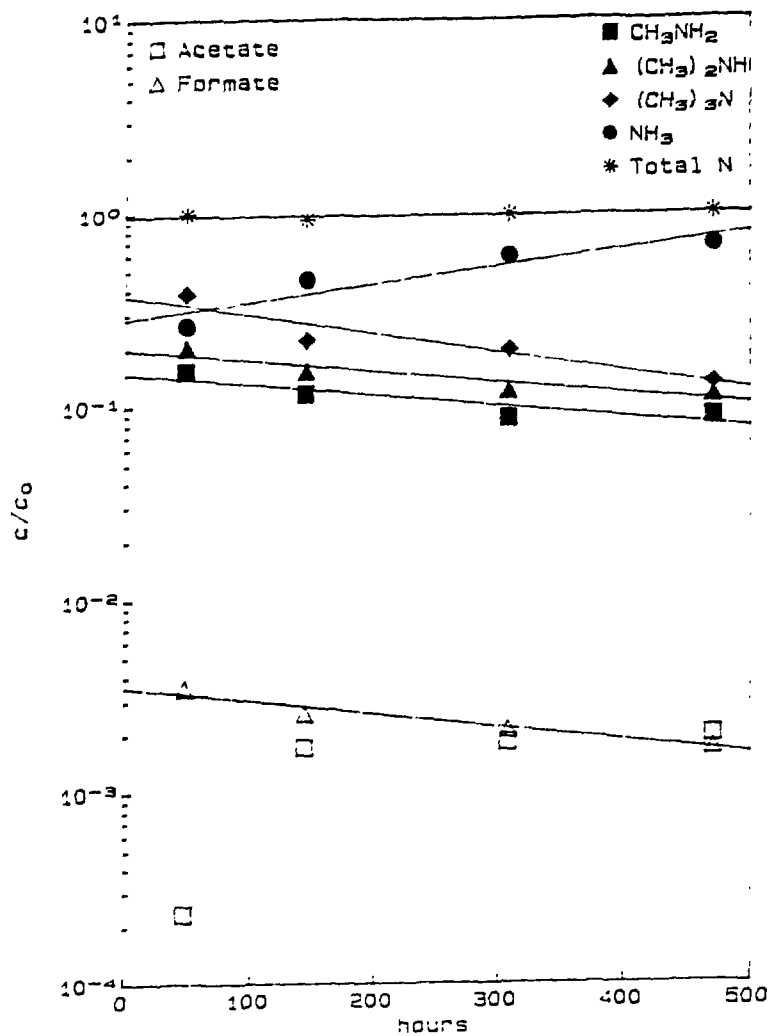
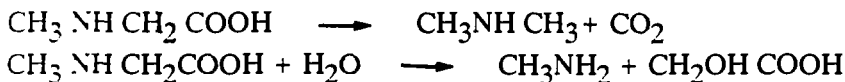

Figure 4. Evolution of the decomposition products of sarcosine at 300°C

C = Concentration of the decomposition product

C₀ = Initial concentration of sarcosine



If concentration is high enough to allow condensation :

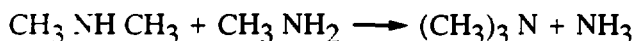

The methylamines formed are hydrolysed through the reactions :

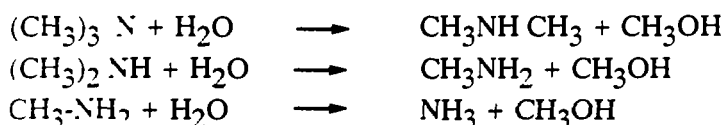

The small decreasing formate concentration is explained by the successive reactions :

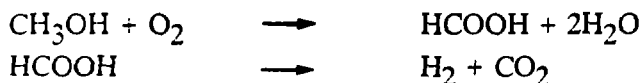

Acetic acid may be produced, in small amount, by the oxidization reaction :



Aminomethylpropanol (AMP) $\text{NH}_2\text{C}(\text{CH}_3)_2\text{CH}_2\text{OH}$

It was not possible to follow the thermal decomposition of AMP in autoclave at 300°C, the product being completely destroyed during the time necessary to reach the temperature (less than 2 h).

A study of vapor phase decomposition at 400°C in a flowing system (undertaken for once-through steam generator) gave indications on the nature of decomposition products and on the decomposition mechanism. The experimental device is represented on figure 2. The tank R, heated at 90°C, contains an AMP solution (0.62 mol.kg^{-1}) which, in these conditions, produces a vapour with a concentration of 0.8 mol.kg^{-1} . The flowrate is governed by the size of the capillary C. Condensable products are trapped in the liquid nitrogen trap P and incondensable gases are extracted by the Toepler pump T to be collected in the gas burette B.

The only cationic species found was ammonia, whose production may therefore be taken as measure of the decomposition. The only anionic species appearing in chromatographic analysis was acetate. Non-ionic species in solution were not analyzed. In gas phase, CH_4 , H_2 and CO , appeared in amount comparable to the one of acetate. Figure 5 shows the variation of the amount

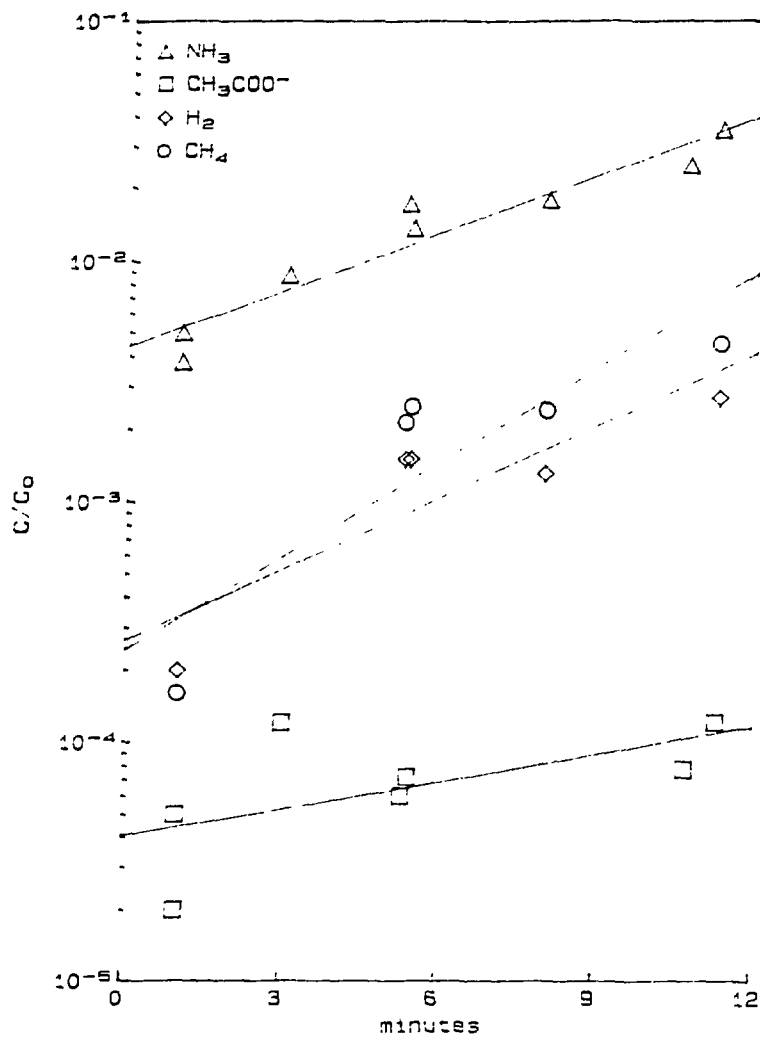

Figure 5. Evolution of the main decomposition products of AMP at 400°C

C = Concentration of the decomposition product

C_0 = Initial concentration of AMP

of these different compounds.

A decomposition mechanism compatible with the analytical results is the following :

Hydrolysis of AMP :



Hydrolysis of isobutylene-glycol :



Oxydation of alcohol by water :



Further decomposition of acetic acid :

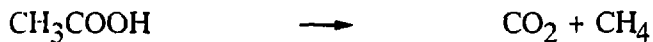

LOOP EXPERIMENTS

Loop experiments have been performed in order to confirm the results of the laboratory tests with thermohydraulic conditions more representative of a real secondary circuit. Two amines have been selected : morpholine which had a relatively low rate of thermal decomposition during the previous laboratory tests, and AMP which had a rapid thermal decomposition at 300°C following the previous tests in autoclave.

Experimental

The ORION facility reproduces the main physico-chemical characteristics of a PWR secondary circuit : the water thermohydraulic cycle and the steam generator feed water train with representative temperatures, materials and transit times. It is mainly composed of a primary circuit and a secondary circuit with a steam generator. All the various components and pipes are made of stainless steel, except the steam generator (carbon steel and Alloy 600). The flow diagram of this secondary circuit is shown in figure 6 with the mean temperatures and the flow rates obtained during this study. Vacuum system reproduces the pressure and the temperature of an actual condenser system. Only turbines and drains recirculation are not reproduced in the ORION facility.

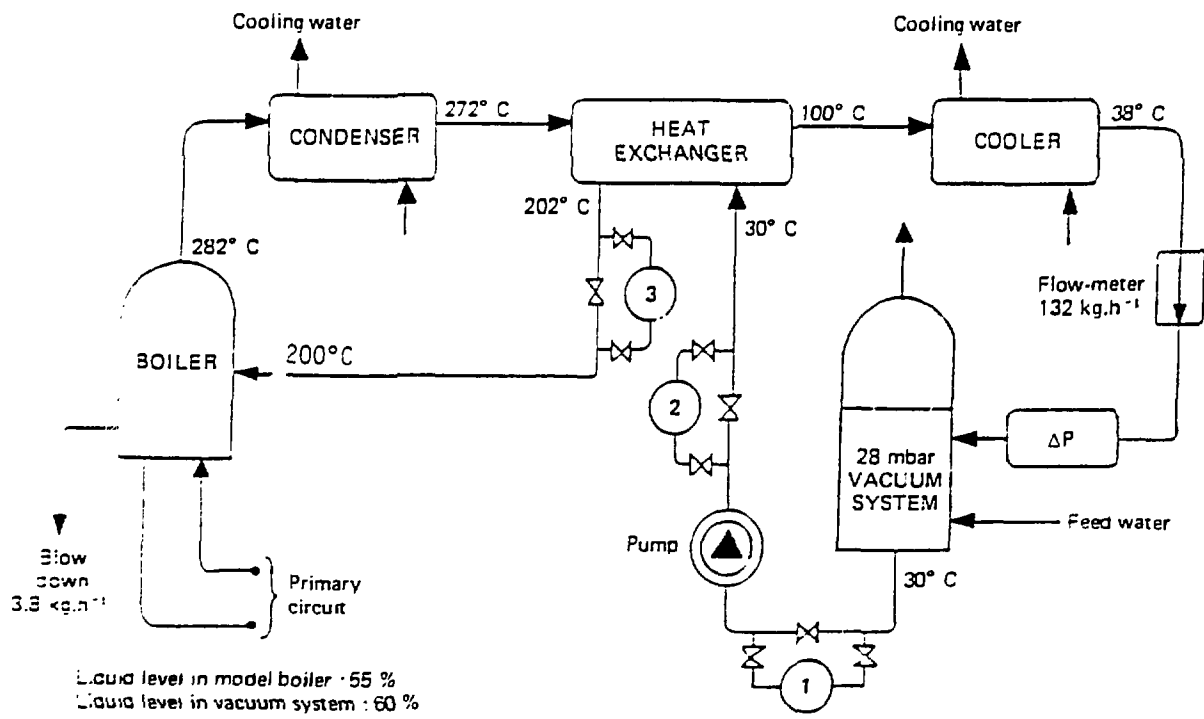

Figure 6. Schematic diagram of ORION secondary circuit with thermohydraulic mean values

Table 1

TEMPERATURES AND TRANSIT TIMES IN ORION SECONDARY CIRCUIT

Localization	ORION LOOP		Fessenheim I (880 MWe French PWR)		
	Temperature	Transit time	Localization	Temperature	Transit time
Vacuum system and simulation capacity 1	30°C	1900 s*	Condenser	30°C	~ 500 s
Feed water train	30-200°C	390 s*	Feed water train	30-216°C	~ 390 s
Boiler	200-282°C	500 s**	Steam Generator	216-272°C	~ 100 s
Condenser and cooler	282-30°C	300 s	Steam circuit	272°C-30°C	steam

* water level in vacuum system 60 %

** water level in boiler 55 %

Temperatures and transit times obtained in ORION secondary circuit are reported on table 1 and compared to those obtained in an actual PWR secondary system (Fessenheim I).

During each run, the thermohydraulic parameters are kept constant as indicated in figure 4 :

vapor flow rate : $132 \pm 5 \text{ kg.h}^{-1}$
vapor temperature : $282 \pm 1 \text{ }^\circ\text{C}$
boiler blowdown : $3.8 \pm 0.5 \text{ kg.h}^{-1}$
boiler inlet : $200 \pm 2 \text{ }^\circ\text{C}$
vacuum system pressure : $28 \pm 5 \text{ mbar}$
vacuum system temperature : $30 \pm 1 \text{ }^\circ\text{C}$

The ORION loop is feeded with ultra pure water, sterilized by filtration at $0.22 \text{ }\mu\text{m}$. Its total conductivity is lower than $0.1 \text{ }\mu\text{S.cm}^{-1}$ and its total organic content is lower than $100 \text{ }\mu\text{g.kg}^{-1}$. Before and after each apparatus or each simulation device, the circuit is fitted with sampling lines. The chemistry is followed by on line analysis or grab samples at any point of interest. Oxygen concentrations are measured continuously with an Orbisphere apparatus. Morpholine, AMP, ammonia, acetate and formate are analyzed by ion chromatography (HPIC).

In order to compare ammonia conditioning with morpholine and AMP conditionings, three runs have been conducted :

- RUN A was the reference run, with only ammonia (duration : 500 h)
- RUN B was conditioned with morpholine (duration : 1000 h)
- RUN C was conditioned with AMP (duration 1000 h)

The two runs with amine were divided into three periods :

- a first period with only ammonia in order to have the same starting point
- a second period with the amine addition and low oxygen content ($< 5 \text{ }\mu\text{g.kg}^{-1}$) in the secondary water
- a third period with the same amine concentration but with higher oxygen content ($> 10 \text{ }\mu\text{g.kg}^{-1}$) in order to determine the effect of oxygen on the thermal stability of the amine.

During the three reported runs, the primary conditioning was the same and based on lithium-boron chemistry :

- 500 mg.kg⁻¹ of boron added as H₃BO₃
- 1.1 mg.kg⁻¹ of lithium added as LiOH
- 30 cm³ TPN.kg⁻¹ of hydrogen added at the beginning of each run.

Results and discussion

The data obtained during the three runs will be compared in order to show the influence of the chemical conditioning on acetate and formate concentrations and on cationic conductivities. Steam-water partition coefficients and decomposition rates observed during the runs will also be presented.

Acetate-formate

Acetate and formate were the main decomposition products observed in the liquid phase during the laboratory tests. The concentrations of these two organic anions were followed during the three runs. The results obtained are summarized on table 2 : with ammonia treatment, the acetate and formate concentrations were low, less than 10 µg.kg⁻¹ ; with morpholine or AMP conditionings, acetates and formates were found at all the sampling points including boiler blowdown, steam or the cold part of the circuit (outlet of condenser - 30°C). In ORION experimental conditions, the presence of organic anions is correlated with the use of morpholine or AMP. This is in agreement with laboratory tests.

It could be noticed on table 2 that some ammonia was found with morpholine and AMP treatment : the presence of ammonia indicates also that a thermal degradation of the two amines occurred, since ammonia is a product of this degradation as shown during laboratory tests.

Cationic conductivities

Cationic conductivities have been measured around the boiler. The stable values obtained at the end of the different periods of the ORION runs are reported on table 3 with the values of oxygen and amine concentrations.

Table 2

INFLUENCE OF THE CHEMICAL CONDITIONING ON ACETATE AND FORMATE

RUN	Amine mg.kg ⁻¹	Ammonia mg.kg ⁻¹	ACETATE/FORMATE (μg/kg)					
			Outlet of condenser simulation (30°C)		Boiler blowdown (282°C)		Steam (282°C)	
			A	F	A	F	A	F
with ammonia	-	0.44	<10	<10	<10	<10	<10	<10
with morpholine	6.5	0.05	175	30	145	80	260	30
with AMP	1.0	0.37	130	180	90	20	90	130

A : Acetate (μg.kg⁻¹)F : Formate (μg.kg⁻¹)

With ammonia alone, the cationic conductivities are in the range of 0.22 - 0.23 $\mu\text{S}\cdot\text{cm}^{-1}$ at the inlet or at the outlet of the boiler ; at the boiler blowdown, the cationic conductivity is higher 0.80 $\mu\text{S}\cdot\text{cm}^{-1}$. With morpholine or AMP treatment, there is an increase of all the cationic conductivities. For instance, at the boiler blowdown, the cationic conductivity reaches 1.15 to 1.20 $\mu\text{S}\cdot\text{cm}^{-1}$. When oxygen concentration increases, the cationic conductivities are higher, not only at the boiler blowdown but also at the boiler inlet or in the steam. This is probably due to the fact that thermal stability of AMP and of morpholine depends on oxygen concentration in the secondary water. It could be noticed also that there is a mismatch between the cationic conductivities and the concentrations of acetate and formate : the presence of some other organic ions and/or the conservation of the samples before the analysis may be the reasons of the differences between measured and calculated cationic conductivities (calculated from the values of acetate and formate concentrations).

Relative volatility

The relative volatility (RV) of amine is defined by the following ratio :

$$\text{Relative volatility} = \frac{\text{amine concentration in steam}}{\text{amine concentration in liquid}}$$

During the three runs, concentrations of ammonia and of amines have been determined at the boiler blowdown and at the boiler outlet (steam). RV mean values calculated from these concentrations are reported in table 4 with their standard deviations. They are compared to some RV values collected in the literature. The high standard deviation of the ammonia relative volatility is due to the fact that the ammonia concentration at the blowdown was low, around 0.08 $\text{mg}\cdot\text{kg}^{-1}$ with an absolute analysis incertitude of $\pm 0.02 \text{ mg}\cdot\text{kg}^{-1}$. The RV values obtained with morpholine (1.16) and AMP (0.96) are in good agreement with literature data.

Decomposition rates

The evolution of amine concentrations in the secondary circuit can be interpreted in terms of thermal degradation. The decomposition rate could be defined by the following ratio :

$$\text{Decomposition rate (\%)} = 100 \times \frac{[\text{amine}]_{\text{in}} - [\text{amine}]_{\text{out}}}{[\text{amine}]_{\text{in}}}$$

Table 3

INFLUENCE OF THE CHEMICAL CONDITIONING ON CATIONIC CONDUCTIVITIES

RUN	Oxygen g.kg ⁻¹	Amine mg.kg ⁻¹	CATIONIC CONDUCTIVITIES (μS.cm ⁻¹)		
			Boiler inlet	Blowdown	Steam
with ammonia	< 10 μg.kg ⁻¹	0.44	0.22	0.80	0.22
with morpholine	3.8	6.5	0.51	1.19	0.61
	12	5.1	0.61	1.96	0.65
with AMP	4.0	1.0	0.45	1.16	0.42
	32	0.9	0.75	1.67	0.74

Table 4
STEAM-WATER RELATIVE VOLATIVITY (RV) AT 282°C

RUN	CONDITIONING	RV (standard deviation)	Literature data	
			[1]	[2]
A	NH ₄ ⁺	5.4(1.8)	4.98	-
B	Morpholine	1.16(0.03)	1.33	1.23
C	AMP	0.96(0.06)	0.90	0.80
D	Morpholine	1.17(0.05)	1.33	1.23

Table 5
DECOMPOSITION RATES

RUN	CONDITIONING	DECOMPOSITION RATES	
		in the boiler (282°C)	in the secondary circuit
A	ammonia	< 2 %	< 2 %
B	Morpholine	< 2 %	< 2 %
C	AMP without O ₂	22 %	33 %
	AMP with O ₂	23 %	42 %

with $[amine]_{in}$ = total quantity of amine which enters the system

$[amine]_{out}$ = total quantity of amine which goes out from the system

The decomposition rates have been calculated for ammonia and for the two tested amines using the above equation and considering the boiler alone or the whole secondary circuit. The results of these calculations are presented on table 5. They show that :

- The morpholine decomposition is not detectable, less than 2 %
- The thermal degradation of AMP is high : around 22 % of AMP which enters the boiler disappears. This percentage reaches 33 % to 42 % in the whole secondary circuit, depending on the oxygen concentration.

These high decomposition rates of AMP have to be correlated to the transit times which are longer in ORION loop : for instance, 500 s in the boiler compared to around 100 s in an actual steam generator. These percentages of AMP decomposition correspond to $0.6 \pm 0.1 \text{ mmol.h}^{-1}$ of AMP decrease which is in accordance with the observed increase of ammonia in the ORION secondary system : between 0.5 and 0.8 mmol.h^{-1} of ammonia increase. These data confirm the thermal degradation of AMP into ammonia (mole to mole), also observed during the laboratory tests.

SUMMARY

The laboratory and loop experiments lead to the main following points :

- Morpholine is thermally more stable than AMP or sarcosine in PWR secondary conditions. Decomposition mechanisms are proposed for the 3 amines.
- The observed increase of pH due to the thermal degradation of sarcosine is a difficulty in using sarcosine as a buffer at high temperatures.
- Acetate and formate are the main organic anions due to the thermal decomposition of these 3 amines. With morpholine and AMP conditionings, the cationic conductivities in the secondary system are slightly higher than with ammonia conditioning.
- Morpholine and AMP thermal stability depends strongly on oxygen concentrations.
- AMP thermal decomposition was important during both laboratory tests and ORION runs. Decomposition products include also ammonia (mole to mole) which is favorable to maintain the basicity of the secondary water, but the high decomposition rate (more than 20 % in ORION boiler) is a difficulty for the use of AMP in PWR secondary conditions.

REFERENCES

- [1] E.A. Wetton, G.G. Lewis "High Temperature pH calculations for solutions of volatile amines" Water Chemistry of Nuclear Reactor Systems 4 - Proceedings of the international conference held in Bournemouth (G.B.) on October 13-17, 1986. Vol 1 - paper 99 pp 355-361.
- [2] J.W. Cobble, J. Turner "The Chemistry of Volatile Acids and Bases in Hot Water - pH Control in Nuclear Reactors" 1988 JAIF International Conference on Water Chemistry in Nuclear Power Plants - April 19-22, 1988, Tokyo (Japan) - Vol 2 pp 486-495.
- [3] V. Dauvois, I. Lambert, D. Desmoulins, F. Nordmann "Laboratory and Plant Investigations on Decomposition Products of Morpholine in the Secondary Systems of French PWRs" Water Chemistry of Nuclear Reactor Systems 4 - Proceedings of the international conference held in Bournemouth (G.B.) on October 13-17, 1986 - Vol 1 - paper 101 pp 369-375.
- [4] D. Feron, I. Lambert, G. Santarini "Thermal stability of morpholine in a PWR secondary system : laboratory and loop experiments" 1988 JAIF International Conference on Water Chemistry in Nuclear Power Plants - April 19-22, 1988, Tokyo (Japan) - Proceedings Vol 2 pp 631-635.