

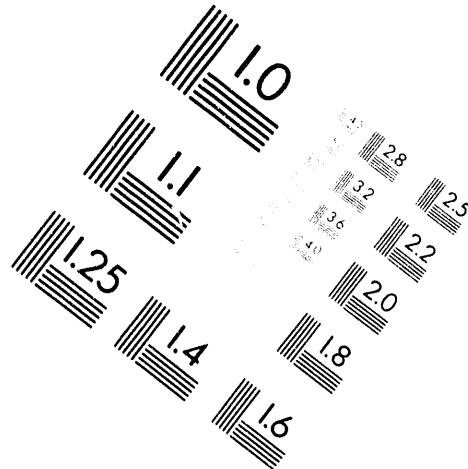

AIIM

Association for Information and Image Management

1100 Wayne Avenue, Suite 1100
Silver Spring, Maryland 20910
301-587-8202

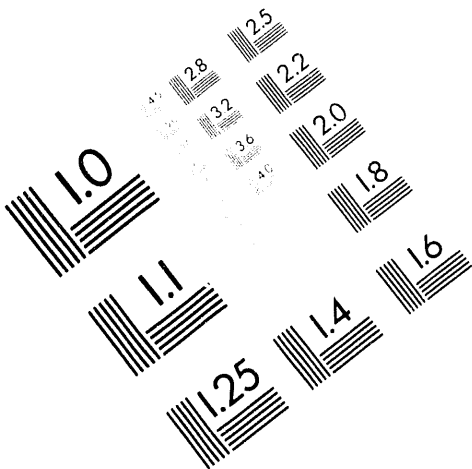

Centimeter

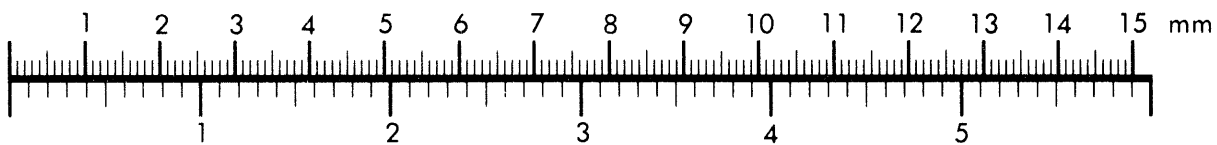

Inches

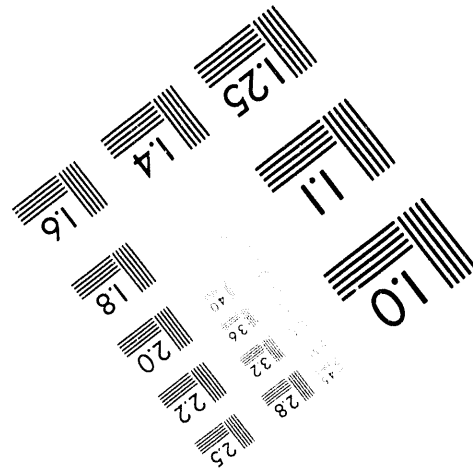
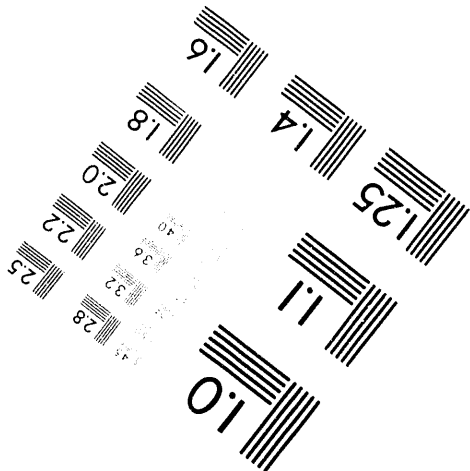
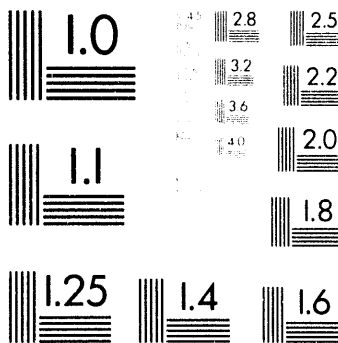

MANUFACTURED TO AIIM STANDARDS
BY APPLIED IMAGE, INC.

1 of 1

TITLE: PERFORMANCE OF A PALLADIUM MEMBRANE REACTOR USING A Ni CATALYST FOR FUSION FUEL IMPURITIES PROCESSING

AUTHOR(S): R.Scott Willms ESA-3
Richard Wilhelm ESA-3
K. Okuno JAERI

SUBMITTED TO: THIRD INTERNATIONAL SYMPOSIUM ON FUSION NUCLEAR TECHNOLOGY
JUNE 27 - JULY 1, 1994 - LOS ANGELES, CA

DISTRIBUTION OF THIS DOCUMENT IS UNLIMITED

MASTER

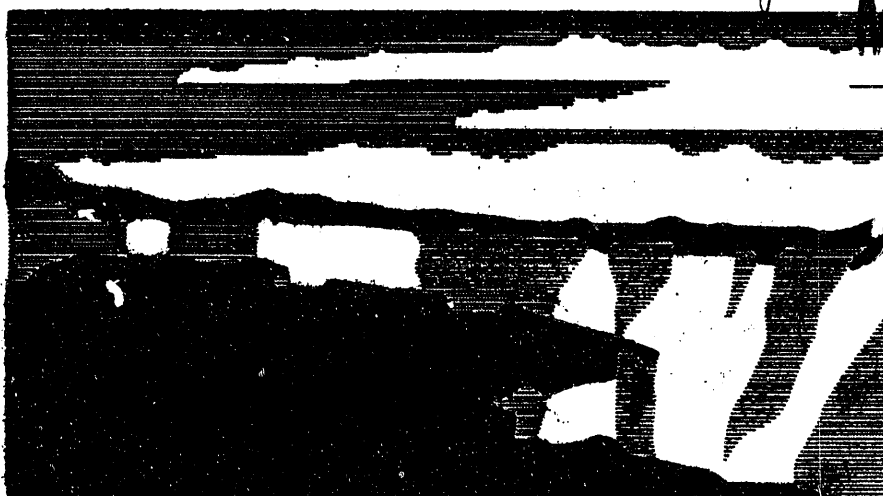

Los Alamos
NATIONAL LABORATORY

Los Alamos National Laboratory, an affirmative action/equal opportunity employer, is operated by the University of California for the U.S. Department of Energy under contract W-7405-ENG-36. By acceptance of this article, the publisher recognizes that the U.S. Government retains a nonexclusive, royalty-free license to publish or reproduce the published form of this contribution, or to allow others to do so, for U.S. Government purposes. The Los Alamos National Laboratory requests that the publisher identify this article as work performed under the auspices of the U.S. Department of Energy.

Performance of a Palladium Membrane Reactor Using a Ni Catalyst for Fusion Fuel Impurities Processing

R. Scott Willms and Richard Wilhelm
Los Alamos National Laboratory
Los Alamos NM 87545

K. Okuno
Japan Atomic Energy Research Institute
Tokai-mura, Naka-gun, Ibaraki-ken, 319-11,
Japan

ABSTRACT

The palladium membrane reactor (PMR) provides a means to recover hydrogen isotopes from impurities expected to be present in fusion reactor exhaust. This recovery is based on reactions such as water-gas shift and steam reforming for which conversion is equilibrium limited. By including a selectively permeable membrane such as Pd/Ag in the catalyst bed, hydrogen isotopes can be removed from the reacting environment, thus promoting the reaction to complete conversion. Such a device has been built and operated at the Tritium Systems Test Assembly (TSTA) at Los Alamos National Laboratory (LANL). For the reactions listed above, earlier study with this unit has shown that hydrogen single-pass recoveries approaching 100% can be achieved. It was also determined that a nickel catalyst is a feasible choice for use with a PMR appropriate for fusion fuel impurities processing. The purpose of this study was to systematically assess the performance of the PMR using a nickel catalyst over a range of temperatures, feed compositions and flowrates. Reactions which were studied are the water-gas shift reaction and steam reforming.

INTRODUCTION

One of the most daunting problems in fusion fuel (a mixture of deuterium and tritium) processing is the recovery of tritium from fusion fuel impurities such as water and methane. Various methods have been used or proposed for this purpose [1], but most suffer from problems such as waste generation, unreliability and complexity. The ideal impurities processing system would 1) be simple to build and operate, 2) generate little or no waste, 3) employ once-through processing, and 4) avoid intermediate processing steps which generate tritiated water. The palladium membrane reactor (PMR) which is the focus of the research reported here may be able to meet all of these criteria.

A palladium membrane reactor is a device which combines a catalytic reactor with a palladium membrane permeator. Catalytic "shift" reactions useful for recovering hydrogen isotopes from water and methane are:

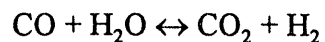

Water-gas Shift

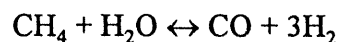

Steam Reforming

Conversions for these reactions are incomplete due to thermodynamic equilibrium limitations. However, the hydrogen product from these reactions can be removed by incorporating into the reactor an evacuated Pd membrane tube, which is only permeable to

hydrogen isotopes. As hydrogen is removed, further shift reaction is facilitated. Through proper geometric design the PMR combines reaction and permeation so that essentially all of the hydrogen isotopes are recovered from the impurities. Due to the nature of the Pd membrane, the hydrogen isotopes exit the PMR in ultrapure form, needing no further processing before either being reinjecting into the fusion device or sent to an isotope separation system.

Membrane reactors using various membrane materials, catalysts and geometries have been examined for diverse applications since the late 1960's. Such applications have been cited previously in [2].

A prototype PMR has been built and tested at the Tritium Systems Test Assembly (TSTA) at Los Alamos National Laboratory (LANL). Earlier work [2] tested a number of catalysts and found that, of those tested, a Ni catalyst was best suited to fusion fuel processing applications. These first "proof-of-principle" experiments demonstrated that a Ni catalyst-packed PMR could effectively recover hydrogen isotopes from water and methane. Under certain conditions, observed hydrogen recoveries approached 100%. The favorable results from that work has motivated further, more detailed study of the PMR. This paper reports on recent experiments which focused on the performance of the Ni catalyst-packed prototype PMR over a range of temperatures, flowrates and feed compositions. The reactions studied were steam reforming and water-gas shift.

EXPERIMENTAL DESCRIPTION

A. The Palladium Membrane Reactor

Figure 1 is a scale drawing of the palladium membrane reactor that has been constructed at TSTA. The central tube is made of 75%Pd/25%Ag and was obtained from Rosemont GmbH & Co., Hanau, Germany. Its dimensions are 530 mm long (including its 11.9 mm flange), 5 mm outer diameter and 0.2 mm wall thickness. It is mounted in an MDC Corp. "Del-Seal" flange, 53.8 mm dia. x 11.9 mm thick, 304 stainless steel. This flange facilitates easy removal of the tube from the reactor shell.

The reactor shell is constructed of 1.65 mm wall thickness 304 stainless. Its inside length is 660 mm measured between the flange surfaces. The shell outer diameter is 25.4 mm. Thermowells are included to measure the membrane surface temperature at three points as shown. The annular space between the membrane and the reactor shell is packed with catalyst. The use of demountable flanges allows for relatively easy access to the inside of the shell for changing catalyst.

Reactant gases are fed to the assembly through a 6.35 mm tube welded into the flange shown at the left. As reactions occur over the catalyst, H_2 is extracted from the annular space via permeation through the Pd/Ag membrane by pumping the inside of the membrane. For a practical application of the PMR, it is this ultrapure H_2 permeate that would be, for example, sent to the cryogenic isotope separation system. That which does not permeate, the retentate, is exhausted through a 6.35 mm tube which has been welded into a radial bore in the shell's flange as shown on the right.

(Figure 1 TSTA's Palladium Membrane Reactor)

Catalyst is typically packed to within about 25 mm from either end. The remaining spaces are filled with stainless steel wool.

The entire assembly is heated by enclosing it in a split-hinge tube furnace. The furnace is mounted vertically and employs three independently controlled heaters to maintain uniform temperature along the length of the reactor.

For all of the tests reported here the PMR annulus was packed with a United Catalyst Ni-based catalyst (type C150-4-03, 6.25 mm pellets). This is generally marketed as a "pre-reforming" catalyst. It has a high Ni content (co-precipitated with alumina) to maximize its activity.

B. Test Stand

Figure 2 shows the experimental test stand which has been built to test the PMR. Up to three gases can be mixed with individual flowrates controlled between 0 and 500 sccm (standard cubic centimeters per minute). To this mixture, water can be added via a syringe pump which injects into a heated line to make steam. The retentate diagnostics include humidity, flowrate, pressure and gas composition using an MTI model M200 gas chromatograph. For the permeate, pressure and flowrate are measured. Pumping for the permeate is provided by a Normetex model 15 scroll pump backed by a metal bellows pump.

A personal computer is used for data acquisition and control. It displays and archives measured values, and sets control valves. A separate personal computer is used to operate the gas chromatograph and analyze its data.

(Figure 2 Schematic of the Palladium Membrane Reactor Experimental Test Stand)

C. Water-gas Shift Experiments

Water-gas shift experiments were conducted with the feed composed of CO and H₂O. One series of runs used a CO:H₂O ratio of 1.5:1 and a second used a ratio of 1.8:1. In all cases an excess of CO was maintained so that stoichiometry would not limit the conversion of all water to H₂.

For each feed composition, data were collected at temperatures of 450, 500, 550 and 600 °C. At each temperature between 7 and 11 feed flowrates were tested with the total feed flowrates usually ranging between about 25 and 450 sccm. A summary of the water-gas shift conditions studied is given in Table 1.

D. Steam Reforming Experiments

Steam reforming experiments were conducted with the feed composed of CH₄ and H₂O. One series of runs used a CH₄:H₂O ratio of 1:1.5 and a second used a ratio of 1:1.25. All

tests were conducted with an excess of water. This is because water is consumed by two reactions. First steam reforming occurs which produces CO. With CO present water can be consumed by the water-gas shift reaction as well as the steam reforming reaction. If the system becomes deficient in water before the methane is consumed, methane cracking will occur as demonstrated in [2]. This results in the undesirable, though reversible deposition of carbon in the reactor.

For each feed composition, data were collected at temperatures of 450, 500, 550 and 600 °C. At each temperature about seven feed flowrates were tested with the total feed flowrates usually ranging between 34 and 200 sccm. A summary of the steam reforming conditions studied is given in Table 1.

As can be observed from Table 1, a large number of conditions were studied. An example of a specific dataset that was collected is presented on Table 2. These specific data from 4/8/94 were collected using a feed composition of CO:H₂O = 1.5:1 and a temperature of 550 °C. As shown, the feed flowrates (both CO and H₂O) and pressure were recorded. For the permeate, the flowrate and pressure were recorded. For the retentate the flowrate and pressure were collected and the gas chromatograph was used to record the concentrations of H₂, CH₄, CO and CO₂. Data similar to these were collected for all of the conditions cited in Table 1.

(Table 1 Summary of Conditions Studied for This Work)

(Table 2 Example Water-Gas Shift Data for Feed Composition of CO:H₂O = 1.5:1 and Temperature = 550 °C)

RESULTS AND DISCUSSION

A. Water-Gas Shift

A measure of how well the PMR is working is given by the hydrogen "recovery". This is defined as:

$$\text{Recovery} = \frac{H_2 \text{ Permeation Flowrate}}{\text{Equivalent Feed Flowrate of } H_2} \cdot 100\% \quad (1)$$

For water-gas shift studies, all hydrogen in the feed is in the form of H₂O. Thus, for water-gas shift equation (1) becomes:

$$\text{Recovery}_{\text{water-gas shift}} = \frac{H_2 \text{ Permeation Flowrate}}{H_2O \text{ Feed Flowrate}} \cdot 100\% \quad (2)$$

A recovery of 100% indicates that hydrogen in all chemical forms fed to the PMR is recovered as ultrapure H₂ in the permeate. The retentate (or bleed) stream, in this case, is hydrogen-free.

The water-gas shift experimentally determined recoveries are given on figures 3 and 4 for feed compositions of $\text{CO}:\text{H}_2\text{O} = 1.5:1$ and $1.8:1$, respectively. Each figure plots H_2 recovery versus total feed flowrate ($\text{CO} + \text{steam}$). The data collected at the four temperatures fall nicely along separate curves.

Over a significant range of low flowrates, recoveries approaching 100% are observed. As the flowrates increase beyond a critical value, there is not sufficient residence time in the PMR for reaction/permeation to occur, and recoveries drop progressively below 100%. The total flowrates at which the recovery curves leave the 100% line are summarized in Table 3. The results for $\text{CO}:\text{H}_2 = 1.8:1$ are marginally better than the $1.5:1$ results.

At low flowrates scatter of recoveries about the 100% line is observed. This is attributed to inaccuracies in the flowmeters from which the recoveries are calculated. The flowmeters used were 0-500 sccm units which have advertised accuracies of ± 5 sccm. The observed scatter about the 100% line is commensurate with this level of measurement error.

Over the temperature range tested, performance improves as temperature increases. This appears to indicate that, for this PMR configuration, performance is limited mostly by permeation. This conclusion is based on the fact that as temperature increases, permeation rates increase, while the thermodynamics of the water-gas shift reaction increasingly favors the H_2O side of the equation. However, it must also be noted that the chemical reaction rate increases with temperature. A mathematical model which takes these various factors into account would be required to properly identify the recovery limiting process.

For the $1.5:1$ composition data, a complete set of data at the four temperatures was collected from 4/6 to 4/8/94. These data are denoted on figure 3 by an "a" in the legend and by open markers. Experiments at the four temperatures were again conducted from 4/13 to 4/14/94. These data are denoted on figure 3 by a "b" in the legend and by filled markers. As shown, where experimental conditions were identical, the observed recoveries are essentially identical, lending credibility to the data.

(Figure 3 Water-Gas Shift Hydrogen Recoveries Using a Feed Composition of $\text{CO}:\text{H}_2\text{O} = 1.5:1$, at various Flowrates and Temperatures)

(Figure 4 Water-Gas Shift Hydrogen Recoveries Using a Feed Composition of $\text{CO}:\text{H}_2\text{O} = 1.8:1$, at various Flowrates and Temperatures)

To compare the water-gas shift results using a feed composition of $\text{CO}:\text{H}_2\text{O} = 1.5:1$ with the $1.8:1$ results, both sets of data are plotted together on figure 5. At 500, 550 and 600 °C it appears that recoveries are marginally better with the feed ratio at $1.8:1$ versus the results at $1.5:1$. At 450 °C there is a negligible difference between the two data sets.

(Figure 5 Comparison of Water-Gas Shift Recoveries for $\text{CO}:\text{H}_2\text{O} = 1.5:1$ and $1.8:1$)

B. Steam Reforming

For steam reforming the feed is composed of two hydrogen-bearing species and equation (1) becomes:

$$\text{Recovery}_{\text{steam reforming}} = \frac{H_2 \text{ Permeation Flowrate}}{2(\text{Feed rate of } CH_4) + (\text{feed rate of } H_2O)} \cdot 100\% \quad (3)$$

The H_2 recoveries for steam reforming feed compositions of $CH_4:H_2O = 1:1.25$ and $1:1.5$ are shown on figures 6 and 7, respectively. As before, recovery is plotted versus the total feed flowrate ($CH_4 + \text{steam}$). Data at the four temperatures tested are shown on each plot. Qualitatively, the steam reforming data is similar to the water-gas shift data. Over a range of low flowrates, recoveries approach 100% and at higher flowrates recoveries fall progressively away from the 100% line.

The flowrates at which the recoveries depart significantly from 100% are summarized in Table 3. The results at $CH_4:H_2O = 1:1.5$ are marginally better than the results at $1:1.25$. These values are substantial smaller than the corresponding values for water-gas shift experiments. At least in part, this can be understood by comparing the stoichiometry of the steam reforming and water-gas shift reactions. For the former each reaction produces 2 moles for product for every mole of reactant, while the latter maintains the same number of moles on both sides of the equation. Thus, for steam reforming, the space velocity in the reactor will be increased in the reaction zone. This will decrease the residence time and, thus, the opportunity for reaction/permeation. This factor of two difference in the stoichiometry may largely explain the factor of two difference in the "point of departure" values. Obviously differences in reaction kinetics and thermodynamics will also contribute to this effect. Permeation considerations should be identical between the two sets of experiments.

Particularly for steam reforming, it is not surprising that performance improves with increasing temperature. For this reaction both kinetics and thermodynamics are more favorable at higher temperatures, and, as before, permeation likewise improves.

(Figure 6 Steam Reforming Hydrogen Recoveries Using a Feed Composition of $CH_4:H_2O = 1:1.25$, at various Flowrates and Temperatures)

(Figure 7 Steam Reforming Hydrogen Recoveries Using a Feed Composition of $CH_4:H_2O = 1:1.5$, at various Flowrates and Temperatures)

To observe the influence of feed composition on performance, both the $CH_4:H_2O = 1:1.5$ and the $CH_4:H_2O = 1:1.25$ data are plotted together on figure 8. This indicates that for all temperatures considered, performance is marginally better with a feed composition of $1:1.5$.

(Figure 8 Comparison of Steam Reforming Recoveries for $CH_4:H_2O = 1:1.25$ and $1:1.5$)

C. Extended Operation

The experiments described in this paper required about 150 hours of operation of the PMR. This included startup, shutdown, temperature changes and feed composition changes. Throughout these tests the same catalyst and membrane were used. These experiments were designed to study parametric effects on performance rather than long term behavior. However, it is apparent from these many hours of operation that no dramatic deterioration or improvement of performance was taking place. No result indicated that catalyst or membrane reconditioning or replacement was warranted. Studies specifically designed to detect long term performance changes are planned for the future.

CONCLUSIONS

Using either water-gas shift or steam reforming, the palladium membrane reactor packed with a nickel catalyst has been shown to be effective at recovering hydrogen in ultrapure form from water and methane. Under certain conditions, hydrogen recoveries approaching 100% were observed. These results were obtained using a single processing pass and without generating any waste other than gaseous carbon oxides. The PMR was found to be simple and reliable to operate.

For both water-gas shift and steam reforming, performance became progressively better as the operating temperature was increased from 450 to 600 °C. For water-gas shift, slightly better performance was observed with the feed composed of CO:H₂O = 1.8:1 compared to 1.5:1. For steam reforming, slightly better performance was observed when the feed was composed of CH₄:H₂O = 1:1.5 rather than 1:1.25.

This work raises expectations of success with regard to realizing the ultimate goal of this research which is to use the PMR to recover tritium from tritiated water and tritiated methane. These experiments lay the ground work necessary for designing and conducting future experiments for this purpose.

ACKNOWLEDGMENTS

The author would like to express gratitude to United Catalyst which donated the catalyst for this study. Thanks are also due to Dr. John Ray of United Catalyst for helpful discussions.

REFERENCES

- [1] R.S. Willms, S. Konishi, "Fuel Cleanup Systems for Fusion Fuel Processing", *Fusion Engr. & Design*, 18, 53-60 (1991).
- [2] R.S. Willms, K. Okuno, "Recovery of Hydrogen from Impurities Using a Palladium Membrane Reactor", Proceedings of the 15th IEEE/NPS Symposium on Fusion Engineering, Hyannis, Mass., p. 85-90, October 11-15, 1993.

Table 1 Summary of Conditions Studied for This Work

Date	Reaction: Steam Reforming or Water-gas Shift	Feed Composition Ratio (CH ₄ :H ₂ O or CO:H ₂ O)	Temperature (°C)	Total Feed Flowrates Tested (sccm)	# Points Collected
3/29/94	SR	1:1.5	450	50-1000	6
3/30/94	SR	1:1.5	500	37	1
3/31/94	SR	1:1.5	500	50-200	6
3/31/94	SR	1:1.5	550	37-125	5
4/1/94	SR	1:1.5	550	150-200	2
4/4/94	SR	1:1.5	600	37-200	7
4/5/94	SR	1:1.5	450	37-200	7
4/6/94	WGS	1.5:1	450	25-200	7
4/7/94	WGS	1.5:1	500	25-200	7
4/8/94	WGS	1.5:1	550	25-300	9
4/8/94	WGS	1.5:1	600	34-300	8
4/13/94	WGS	1.5:1	450	34-400	10
4/14/94	WGS	1.5:1	500	34-400	10
4/14/94	WGS	1.5:1	550	350-400	2
4/14/94	WGS	1.5:1	600	300-450	4
4/15/94	SR	1:1.25	600	34-180	7
4/18/94	SR	1:1.25	550	34-180	7
4/22/94	SR	1:1.25	450	34-180	7
4/22/94	SR	1:1.25	500	34-180	7
5/4/94	WGS	1.8:1	450	31-420	11
5/5/94	WGS	1.8:1	500	31-420	11
5/10/94	WGS	1.8:1	550	31-420	11
5/11/94	WGS	1.8:1	600	31-327	9
5/12/94	WGS	1.8:1	600	175-420	2

Table 2 Example Water-Gas Shift Data for Feed Composition of CO:H₂O = 1.5:1 and Temperature = 550 °C

Feed			Permeate		Retentate					
F _{CO} (sccm)	F _{H₂O} (ml _{liq} /min)	P (torr)	Flow (sccm)	P (torr)	F (sccm)	P (ton)	H ₂ (%)	CH ₄ (%)	CO (%)	CO ₂ (%)
15.2	0.008	593	10.0	0.220	16.4	597	0.05	0	19.2	81.2
19.9	0.011	595	13.4	0.317	26.9	600	0.07	0	20.4	80.6
30.2	0.016	595	20.0	0.342	28.3	600	0.09	0	20.5	80.8
50.6	0.027	597	33.9	0.439	63.2	600	0.14	0	20.9	80.6
70.0	0.038	597	48.3	0.537	83.7	600	0.19	0	20.3	80.8
90.0	0.048	598	60.1	0.610	146.3	600	0.31	0	21.4	79.6
120.0	0.064	600	80.1	0.757	165.5	600	1.11	0	20.2	79.0
150.1	0.080	600	93.8	0.855	251.0	600	3.31	0.225	21.8	75.0
180.1	0.097	603	103.8	0.928	295.4	600	6.10	0.853	23.1	71.2

Table 3 Summary of Flowrates at which H₂ Recovery Drops Away from the 100% Line

	Total Flowrate at Which H ₂ Recovery Drops Away from the 100% Line (sccm)			
Temp. (°C)	CO:H ₂ O=1.5:1	CO:H ₂ O=1.8:1	CH ₄ :H ₂ O=1:1.25	CH ₄ :H ₂ O=1:1.5
450	120	120	55	65
500	170	170	85	90
550	210	220	110	115
600	250	270	130	140

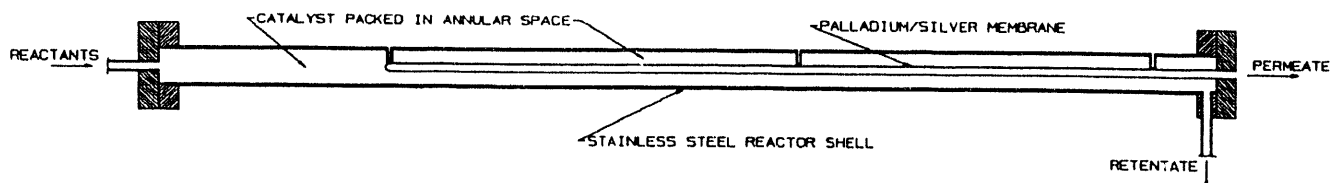

Figure 1 TSTA's Palladium Membrane Reactor

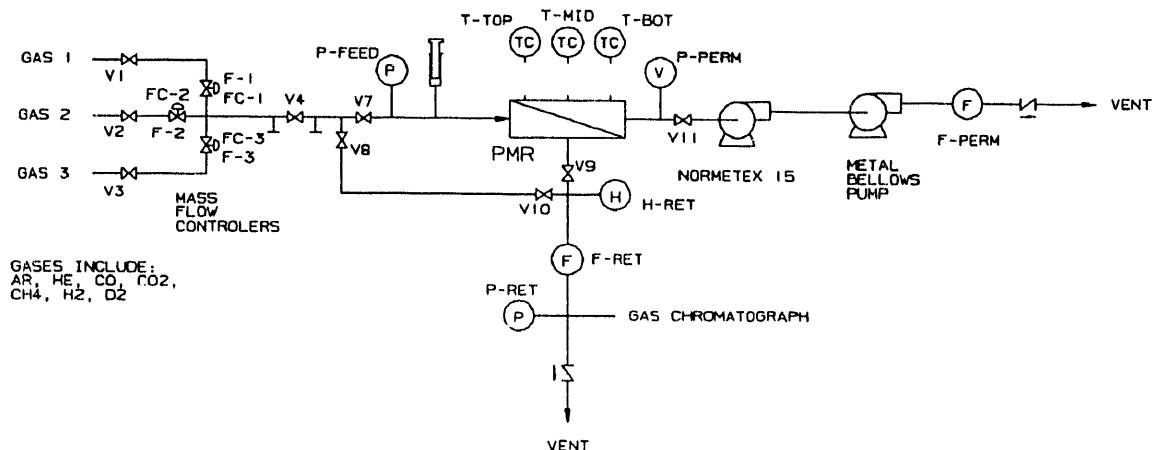

Figure 2 Schematic of the Palladium Membrane Reactor Experimental Test Stand

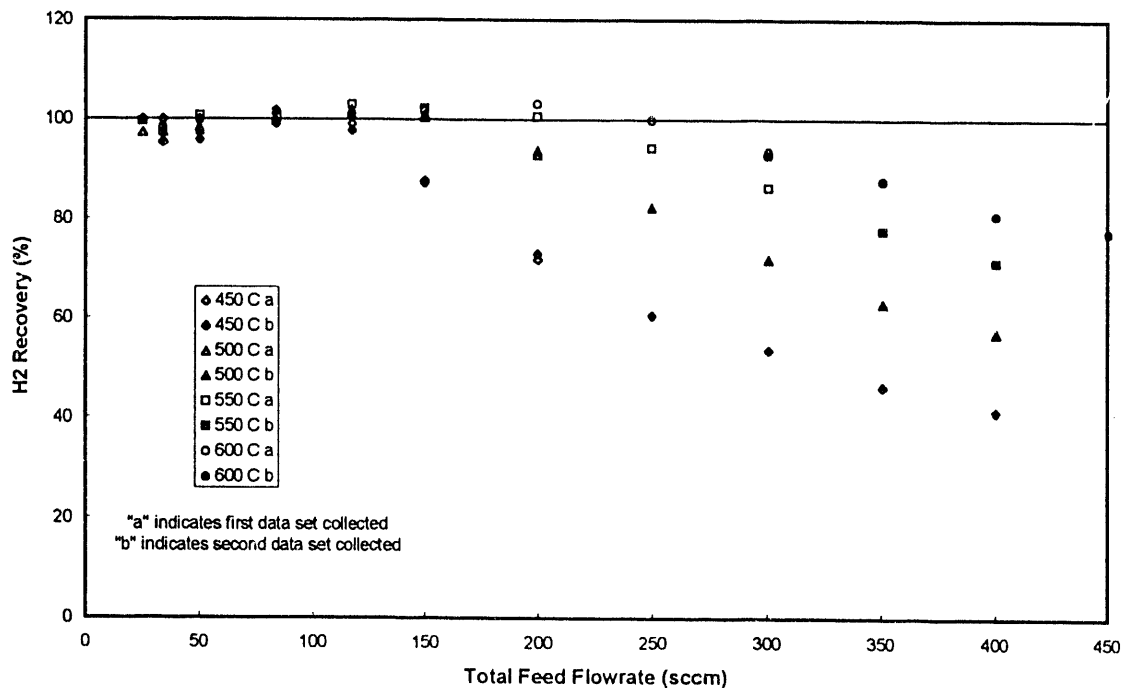

Figure 3 Water-Gas Shift Hydrogen Recoveries Using a Feed Composition of CO:H₂O = 1.5:1, at various Flowrates and Temperatures

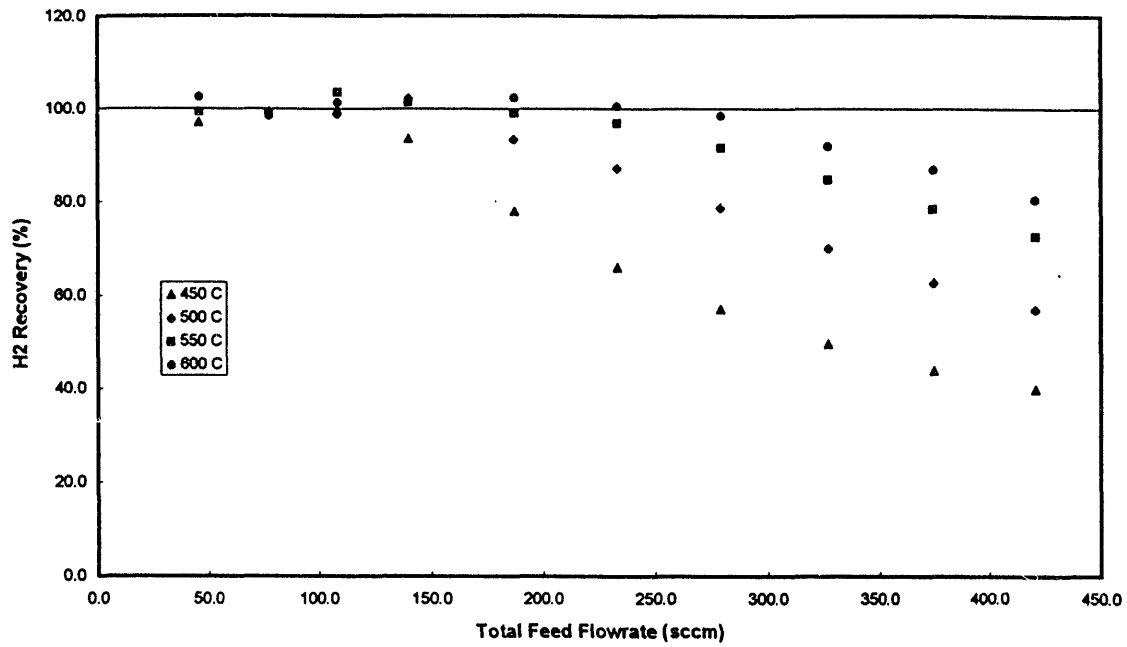

Figure 4 Water-Gas Shift Hydrogen Recoveries Using a Feed Composition of CO:H₂O = 1.8:1, at various Flowrates and Temperatures

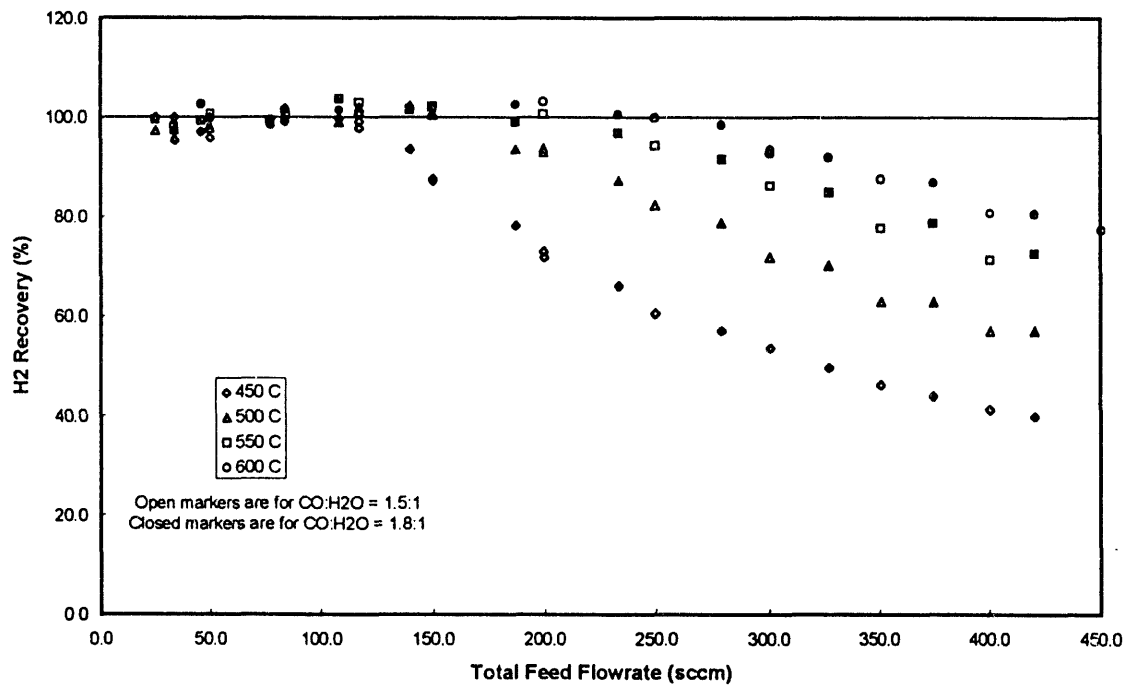

Figure 5 Comparison of Water-Gas Shift Recoveries for CO:H₂O = 1.5:1 and 1.8:1

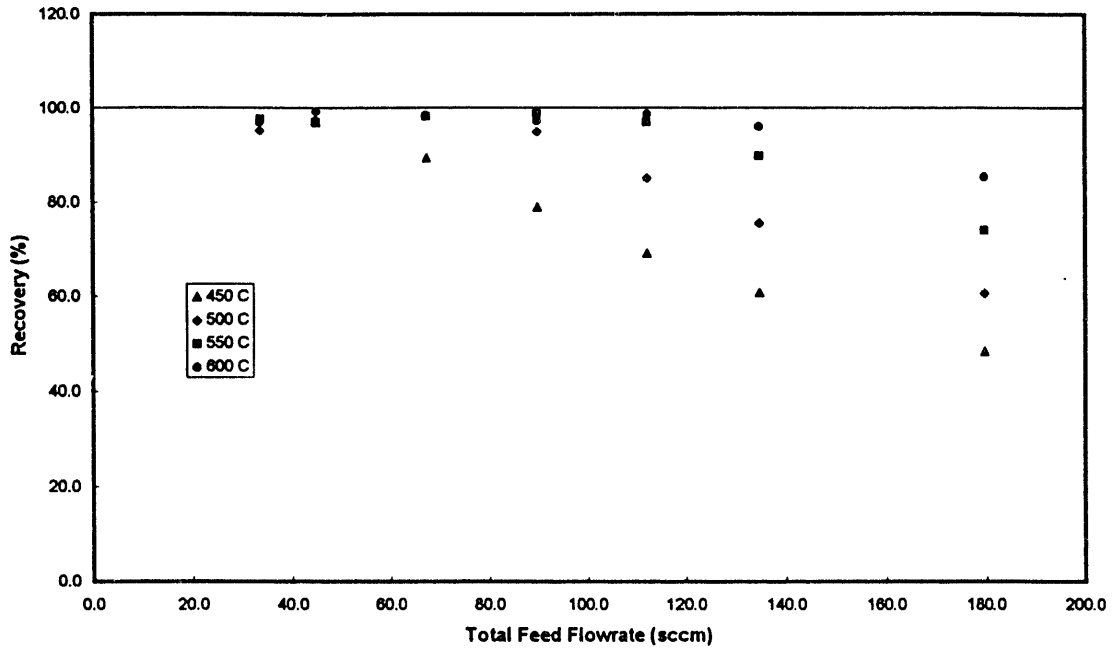

Figure 6 Steam Reforming Hydrogen Recoveries Using a Feed Composition of $\text{CH}_4:\text{H}_2\text{O} = 1:1.25$, at various Flowrates and Temperatures

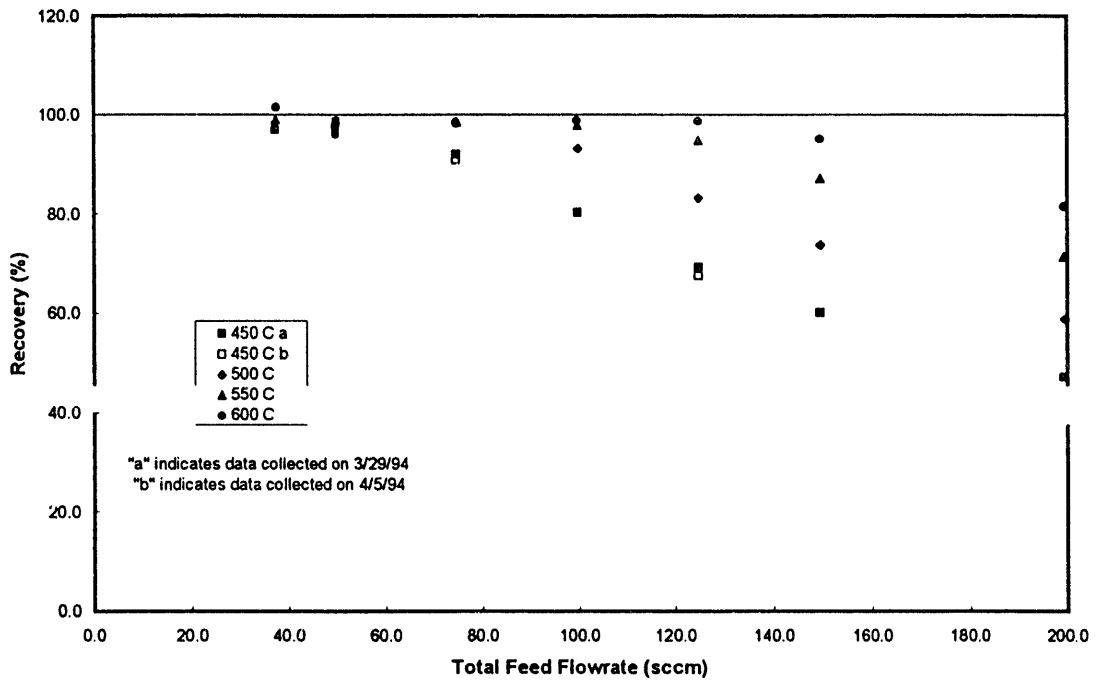

Figure 7 Steam Reforming Hydrogen Recoveries Using a Feed Composition of $\text{CH}_4:\text{H}_2\text{O} = 1:1.5$, at various Flowrates and Temperatures

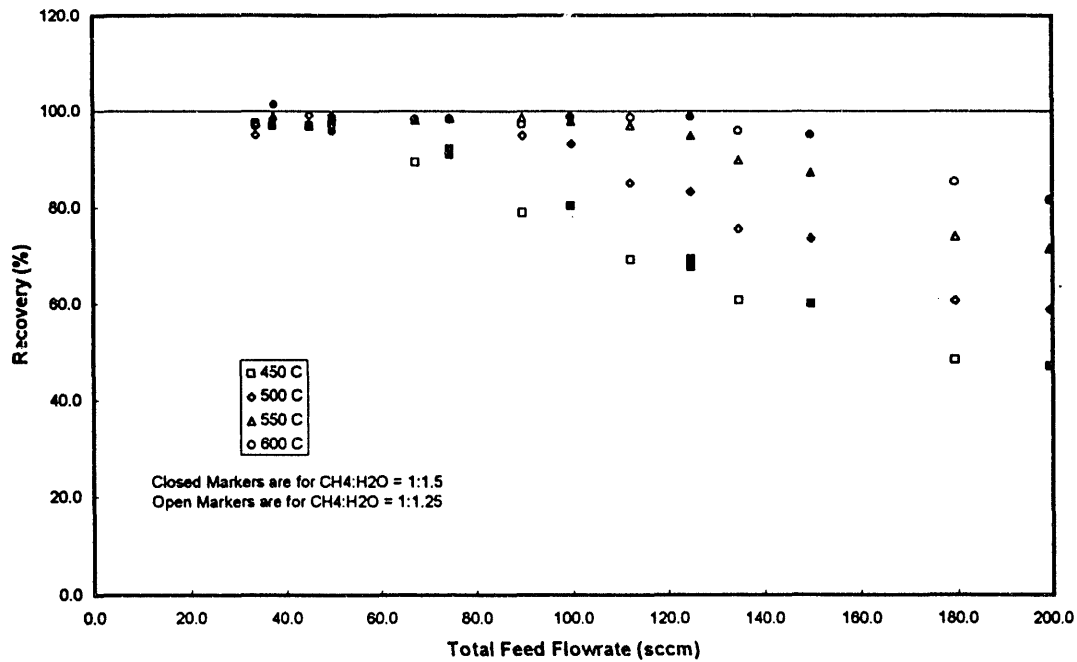

Figure 8 Comparison of Steam Reforming Recoveries for CH₄:H₂O = 1:1.25 and 1:1.5

DISCLAIMER

This report was prepared as an account of work sponsored by an agency of the United States Government. Neither the United States Government nor any agency thereof, nor any of their employees, makes any warranty, express or implied, or assumes any legal liability or responsibility for the accuracy, completeness, or usefulness of any information, apparatus, product, or process disclosed, or represents that its use would not infringe privately owned rights. Reference herein to any specific commercial product, process, or service by trade name, trademark, manufacturer, or otherwise does not necessarily constitute or imply its endorsement, recommendation, or favoring by the United States Government or any agency thereof. The views and opinions of authors expressed herein do not necessarily state or reflect those of the United States Government or any agency thereof.

DATE

FILMED

8/12/94

END

