

Pacific Northwest National Laboratory

Operated by Battelle for the
U.S. Department of Energy

Spent Fuel Drying System Test Results (First Dry-Run)

G. S. Klinger
B. M. Oliver
J. Abrefah

S. C. Marschman
P. J. MacFarlan
G. A. Ritter

July 1998

RECEIVED

SEP 24 1998

OSTI

MASTER

DISTRIBUTION OF THIS DOCUMENT IS UNLIMITED

Prepared for the U.S. Department of Energy
under Contract DE-AC06-76RLO 1830

DISCLAIMER

This report was prepared as an account of work sponsored by an agency of the United States Government. Neither the United States Government nor any agency thereof, nor Battelle Memorial Institute, nor any of their employees, makes any warranty, express or implied, or assumes any legal liability or responsibility for the accuracy, completeness, or usefulness of any information, apparatus, product, or process disclosed, or represents that its use would not infringe privately owned rights. Reference herein to any specific commercial product, process, or service by trade name, trademark, manufacturer, or otherwise does not necessarily constitute or imply its endorsement, recommendation, or favoring by the United States Government or any agency thereof, or Battelle Memorial Institute. The views and opinions of authors expressed herein do not necessarily state or reflect those of the United States Government or any agency thereof.

PACIFIC NORTHWEST NATIONAL LABORATORY

operated by

BATTELLE

for the

UNITED STATES DEPARTMENT OF ENERGY

under Contract DE-AC06-76RLO 1830

Printed in the United States of America

Available to DOE and DOE contractors from the
Office of Scientific and Technical Information, P. O. Box 62, Oak Ridge, TN 37831;
prices available from (615) 576-8401.

Available to the public from the National Technical Information Service,
US Department of Commerce, 5285 Port Royal Rd., Springfield, VA 22161



This document was printed on recycled paper

(9/97)

DISCLAIMER

Portions of this document may be illegible in electronic image products. Images are produced from the best available original document.

Spent Fuel Drying System Test Results (First Dry-Run)

G. S. Klinger
B. M. Oliver
J. Abrefah

S. C. Marschman
P. J. MacFarlan
G. A. Ritter

July 1998

Prepared for
the U.S. Department of Energy
under Contract DE-AC06-76RLO 1830

Pacific Northwest National Laboratory
Richland, Washington 99352

This page(s) is (are) intentionally left blank.

Summary

The test discussed in this report is part of a series of tests being conducted by Pacific Northwest National Laboratory (PNNL) on the drying behavior of N-Reactor spent nuclear fuel (SNF) elements that had been stored underwater in the Hanford 100 Area K-Basins. The drying test series was designed to test fuel elements that ranged from intact to severely damaged.

The test discussed here was a dry-run using the test apparatus without a fuel element. This dry-run was conducted to obtain information on the background levels of water, hydrogen, and other gases. This information is used to better understand the behavior of various components of the drying system, such as particulate filters and the retort assembly materials, on the overall results of testing on fuel elements.

The drying test was conducted in the Whole Element Furnace Testing System located in G-Cell within the Postirradiation Testing Laboratory (PTL, 327 Building). The furnace testing system is composed of three basic subsystems: the in-cell furnace equipment, the system gas loop, and the analytical instrument package. This system was subjected to drying processes based on those proposed under the Integrated Process Strategy, which included a hot drying step. The test cycles are listed below:

- Cold Vacuum Drying (CVD) at $\sim 50^{\circ}\text{C}$ under vacuum, with argon gas flow, for 66 hr
- Pressure Rise Test under static low-pressure conditions at $\sim 50^{\circ}\text{C}$ for ~ 3 hr
- Gas Evolution Test at 75°C , at near-atmospheric pressure, using an argon background gas for approximately 20 hr
- Hot Vacuum Drying (HVD) at 310°C under vacuum for a total of ~ 30 hr (24 hr heatup to 310°C at atmospheric pressure, followed by 6 hr at 310°C)
- Final Water Removal Verification Test at 425°C , under vacuum, for ~ 12 hr
- System cooldown to ambient conditions.

Removal of all free water from the test system retort was essentially completed within the CVD period. Remaining free water was removed from other parts of the test system at temperatures above $\sim 50^{\circ}\text{C}$. Water removed during the latter stages of CVD was calculated to be ~ 40 mg, and was similar to that observed during the previous drying tests of Elements 1990 (Run 1) and 3128W (Run 2). This latter result indicates that most of the free water is removed from the system retort (and fuel element) by the end of the condenser pumpdown phase of CVD.

The Pressure Rise Test showed a linear pressure rise with time for both total pressure and water vapor pressure. The relative magnitudes of the increases were consistent with air in-leakage from the cell environment.

The Gas Evolution Test also showed an increase in the water vapor pressure. The release rate was nonlinear and showed a temperature dependence. The moisture release rate at a temperature equilibrium of $\sim 80^{\circ}\text{C}$ was ~ 2 Torr/hr compared to ~ 0.3 mTorr/hr for the Pressure Rise Test.

Approximately 36 mg of additional water were released following CVD, particularly during the Gas Evolution Test and ramp to 300°C (HVD step 1). The most likely source of the water release is desorption from fiberglass components of particulate filters as a result of heating by the hot argon flow gas. Subsequent tests, including a second dry-run, were not complicated by this effect. The data from this dry-run test can serve as a baseline for the first two fuel element tests, 1990 (Run 1) and 3128W (Run 2). The results of this dry-run testing are necessary for the proper interpretation of the fuel element test data.

Quality Assurance

This work was conducted under the Quality Assurance Program, Pacific Northwest National Laboratory (PNNL) SNF-70-001, *SNF Quality Assurance Program*, as implemented by the PNNL *SNF Characterization Project Operations Manual*. This QA program has been evaluated and determined to effectively implement the requirements of DOE/RW-0333P, Office of Civilian Radioactive Waste Management *Quality Assurance Requirements and Description (QARD)*. Compliance with the QARD is mandatory for projects that generate data used to support the development of a permanent High-Level Nuclear Waste repository. Further, the U.S. Department of Energy has determined that the testing activities which generated the results documented in this report shall comply with the QARD. Supporting records for the data in this report are located in the permanent PNNL SNF Characterization Project records, *Furnace Testing of First Dry-Run*.

This page(s) is (are) intentionally left blank.

Contents

Summary	iii
Quality Assurance	v
Acronyms	xi
1.0 Introduction.....	1.1
2.0 Whole Element Furnace Testing System	2.1
2.1 Major Systems Overview	2.1
2.2 Vacuum Pumping System.....	2.4
2.2.1 Varian Scroll Pump.....	2.4
2.2.2 Water Condenser	2.4
2.2.3 Piping, Valves, and Filters.....	2.5
2.2.4 System Line Heaters	2.5
2.3 Process Heating System.....	2.5
2.4 Gas Supply/Distribution System.....	2.7
2.5 Gas Analysis Instrumentation.....	2.8
2.5.1 Balzers Omnistar Mass Spectrometer	2.8
2.5.2 MTI M200 Gas Chromatograph	2.8
2.6 Process Instrumentation.....	2.9
2.6.1 Panametrics Moisture Monitor	2.9
2.6.2 MKS Baratron Pressure Transducers.....	2.10
2.6.3 Cole-Parmer Pressure Transducers.....	2.11
2.6.4 Thermocouples	2.11

2.7	Data Acquisition and Control System	2.11
3.0	Furnace Testing.....	3.1
3.1	Initial Conditions	3.1
3.1.1	Cold Vacuum Drying.....	3.1
3.1.2	Pressure Rise Test.....	3.3
3.1.3	Gas Evolution Test	3.3
3.1.4	Hot Vacuum Drying, Step 1	3.3
3.1.5	Hot Vacuum Drying, Step 2	3.3
3.1.6	Water Removal Verification.....	3.4
3.2	Calculation of Water and Hydrogen Inventories	3.4
4.0	Experimental Results	4.1
4.1	Cold Vacuum Drying.....	4.1
4.2	Pressure Rise Test.....	4.3
4.3	Gas Evolution Test	4.6
4.4	Hot Vacuum Drying	4.6
4.5	Water Removal Verification.....	4.9
4.6	Mass Spectrometer Measurements	4.9
4.7	Gas Chromatograph Measurements.....	4.12
5.0	Discussion	5.1
6.0	References.....	6.1
7.0	Supporting Documents and Related Reports	7.1

Figures

2.1	Fuel Element Furnace Components (in-cell)	2.2
2.2	Fuel Element Furnace Components (ex-cell).....	2.3
2.3	Generalized View of the Furnace Testing System	2.6
4.1	First Dry-Run Test, Summary Plot	4.2
4.2	First Dry-Run Test, CVD in Vacuum	4.4
4.3	First Dry-Run Test, Pressure Rise in Vacuum	4.5
4.4	First Dry-Run Test, Gas Evolution Test	4.7
4.5	First Dry-Run Test, Hot Vacuum Drying - Step 1	4.8
4.6	First Dry-Run Test, Hot Vacuum Drying - Step 2	4.10
4.7	First Dry-Run Test, Water Removal Test	4.11
4.8	Hydrogen Release During CVD.....	4.13
4.9	Hydrogen Release During HVD	4.14

Tables

2.1	Water and Ice Vapor Pressure Data Versus Temperature.....	2.10
3.1	Summary of Test Conditions	3.2
4.1	First Dry-Run Time Line	4.3

This page(s) is (are) intentionally left blank.

Acronyms

ATS	Applied Test Systems
CVD	Cold Vacuum Drying
DACS	data acquisition and control system
GC	gas chromatograph
HP	Hewlett Packard
HVD	Hot Vacuum Drying
ID	inside diameter
IPS	Integrated Process Strategy
MS	mass spectrometer
NIST	National Institute for Standards and Technology
OD	outside diameter
PNNL	Pacific Northwest National Laboratory
PTL	Postirradiation Testing Laboratory
QARD	Quality Assurance Requirements and Description
SNF	spent nuclear fuel
UHP	ultra high purity
VP	vapor pressure

1.0 Introduction

The water-filled K-Basins in the Hanford 100 Area have been used to store N-Reactor spent nuclear fuel (SNF) since the 1970s. Because some leaks in the basin have been detected and some of the fuel is breached due to handling damage and corrosion, efforts are underway to remove the fuel elements from wet storage. An Integrated Process Strategy (IPS) has been developed to package, dry, transport, and store these metallic uranium fuel elements in an interim storage facility on the Hanford Site (WHC 1995). Information required to support the development of the drying processes, and the required safety analyses, is being obtained from characterization tests conducted on fuel elements removed from the K-Basins. A series of whole element drying tests (reported in separate documents, see Section 7.0) have been conducted by Pacific Northwest National Laboratory (PNNL)^(a) on several intact and damaged fuel elements recovered from both the K-East and K-West Basins. This report documents the results of the first dry-run test, which was conducted without a fuel element. The empty test apparatus was subjected to a combination of low- and high-temperature vacuum drying treatments that were intended to mimic, wherever possible, the fuel treatment strategies of the IPS. The data from this dry-run test can serve as a baseline for the first two fuel element tests, 1990 (Run 1) and 3128W (Run 2).

The purpose of this dry-run was to establish the background levels of hydrogen in the system, and the hydrogen generation and release characteristics attributable to the test system without a fuel element present. This test also serves to establish the background levels of water in the system and the water release characteristics. The system used for the drying test series was the Whole Element Furnace Testing System, described in Section 2.0, which is located in the Postirradiation Testing Laboratory (PTL, 327 Building). The test conditions and methodology are given in Section 3.0, and the experimental results provided in Section 4.0. These results are further discussed in Section 5.0.

(a) Operated by Battelle for the U.S. Department of Energy under Contract DE-AC06-76RLO 1830.

2.0 Whole Element Furnace Testing System

A complete description for the Whole Element Furnace Testing System, including detailed equipment specifications, is provided in Ritter et al. (1998).

2.1 Major Systems Overview

An overview of the furnace testing system is presented in this section. The subsystems pertinent to this test report are as follows:

- **Vacuum Pumping System** – This system consists of a scroll-type vacuum pump, a condenser with chiller, filters, valves, and piping, which provide the vacuum pressures and flows required for the proposed IPS vacuum processes.
- **Process Heating System** – This system consists of a resistively heated, clam-shell furnace and a sample chamber (retort) to provide heating to the fuel element and to control process temperatures.
- **Gas Supply/Distribution System** – This system consists of gas bottles; mass flow controllers; piping; and valves for metering argon, air, or oxygen through the system. A bubbler is also available for adding water vapor to the system if desired.
- **Gas Analysis Instrumentation** – The gas analysis instrumentation includes a 300-amu quadrupole mass spectrometer (MS) and a gas chromatograph (GC) for monitoring selected elements in the process gas stream.
- **Process Instrumentation** – The system is equipped with several instruments for measuring process temperatures, pressures, and moisture level. An auxiliary turbo vacuum pumping system provides low system pressures for zero adjustment of the high accuracy retort pressure sensor.
- **Data Acquisition and Control System (DACS)** – The DACS consists of an IBM-compatible computer and data acquisition/control unit to monitor/store key system parameters (temperatures, pressures, flows, moisture level), along with controlling the process heating system and a safety argon system.

Figures 2.1 and 2.2 are photographs of the equipment located inside and outside of the PTL G-Cell. The furnace (including retort) and some of the process piping, instrumentation, and valves are located inside the hot cell. The furnace sits on the cell floor, and the process piping is routed to a rack that hangs on the west cell wall. Process piping and electrical power and instrumentation wires pass through several split plugs on the west side of the cell. The process piping on the outside of the cell is contained within a glove bag, which provides a secondary containment as a precaution in case the process piping lines become contaminated. The vacuum pump, condenser, bubbler, GC, and the remainder of the instrumentation and valves are located inside this glove bag. Instrumentation and electrical power wires are routed through pass-through sleeves on the sides of the glove bag to the instrument rack and computer console.

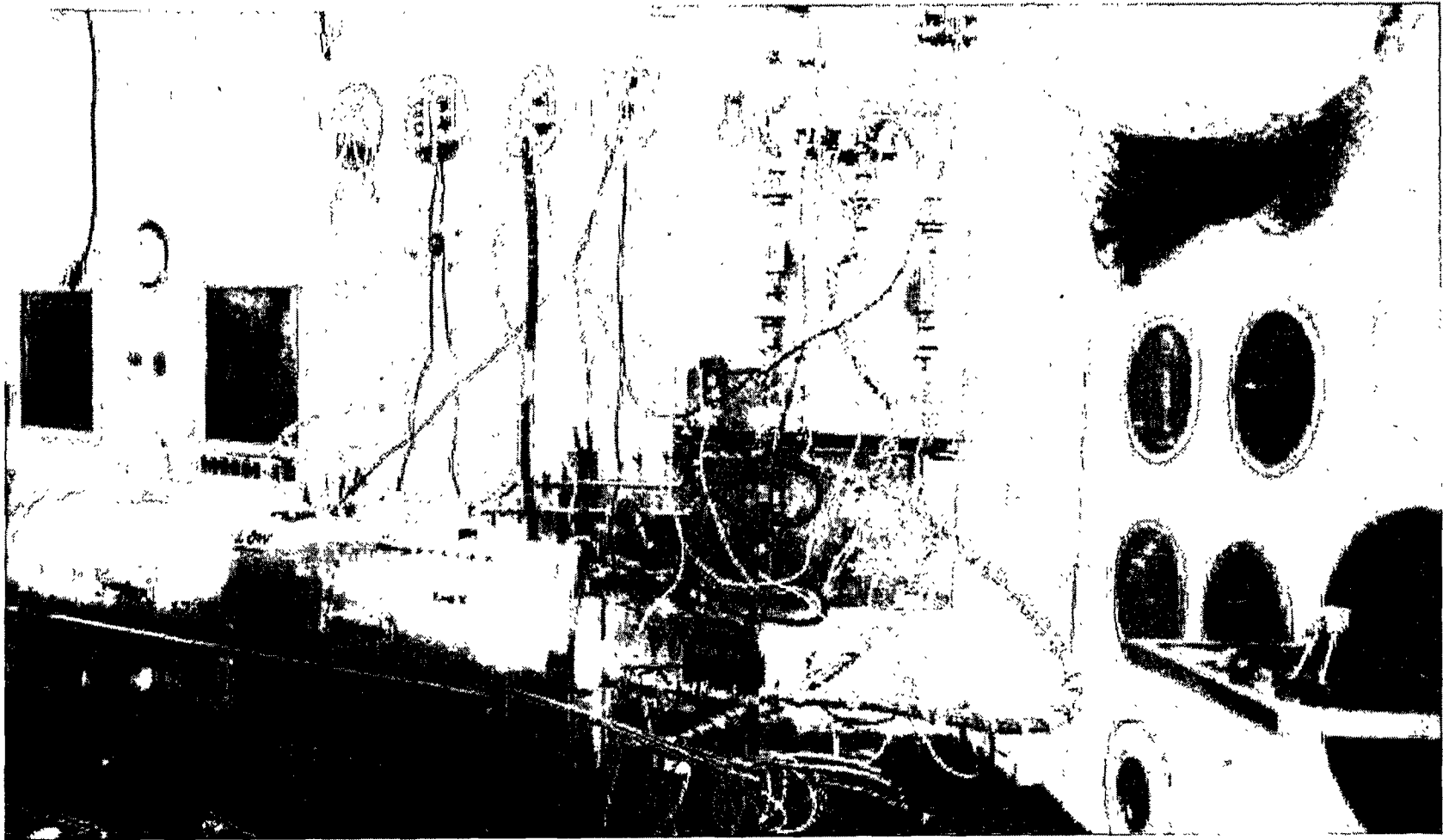

Figure 2.1. Fuel Element Furnace Components (in-cell)

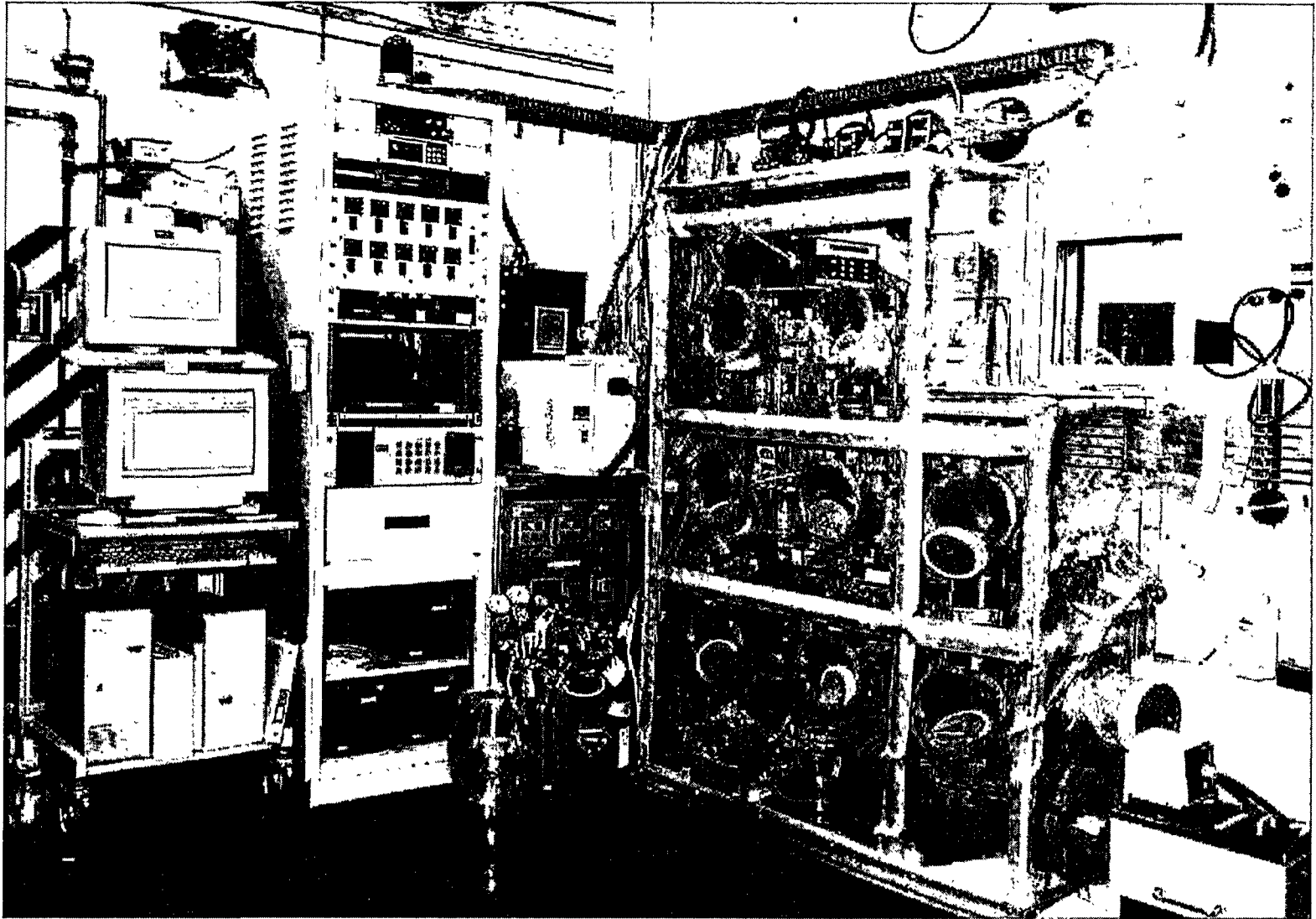

Figure 2.2. Fuel Element Furnace Components (in-cell)

The instrument rack contains the readout/control units for the pressure sensors, moisture sensor, and flow controllers, along with the heat trace temperature controllers, data acquisition/control unit, turbo pump controller, GC laptop computer, and uninterruptible power supplies. The computers for the DACS and MS are located next to the instrument rack. The following sections provide more detailed descriptions of the components for these subsystems.

2.2 Vacuum Pumping System

The vacuum pumping system provides the pressures and flows required for the proposed IPS processes. This system connects the furnace retort with all the other components of the test system through various valves, fittings, and piping. The vacuum pumping system consists of the following components:

- scroll pump for evacuating the system to pressures below 1 Torr
- water condenser with refrigerated chiller for gross removal of water
- valves and piping for connecting the various components and controlling the flow direction
- particulate filters to prevent spread of contamination
- heating cords with temperature controllers for preventing condensation in lines.

2.2.1 Varian Scroll Pump

The system vacuum pump is a Varian model 300DS scroll pump. This pump has an ultimate vacuum pressure less than 10^{-2} Torr and a peak pumping speed of 250 l/min (8.8 cfm). These pressures and flows are more than adequate for simulating the conditions of the proposed IPS vacuum processes. For a single fuel element, this amount of flow may be more than desired. Therefore, a metering valve was installed on the pump inlet to throttle the flow to lower levels as required. The desired system pressure is achieved either by using the metering valve or by flowing ultra high purity (UHP) argon into the system through the entire gas loop or via a direct injection of ballast gas at the pump inlet. The use of argon gas helps to prevent the in-leakage of moisture-containing air through small system leaks (which are difficult to eliminate) that would interfere with process monitoring equipment.

2.2.2 Water Condenser

The scroll vacuum pump can be damaged by condensation of liquid water in the scroll mechanism, and, since each fuel element is wet at the start of each test, the possibility of pump damage was considered. A water condenser with corresponding chiller was installed in the system to condense the bulk of the water before it reaches the pump. This condenser can be valved into the system in series with the scroll vacuum pump or can be bypassed if not needed. The condenser cannot trap all the liberated free water, but is efficient at removing the majority of free water in the system. The condenser is only used

during the first phase of a Cold Vacuum Drying (CVD) test for a single fuel element. The condenser was custom fabricated specifically for this system. Detailed sketches and specifications for the condenser are given in Ritter et al. (1998).

2.2.3 Piping, Valves, and Filters

The vacuum pumping system connects the system components through various valves, fittings, and piping. A simplified piping schematic for the system is shown in Figure 2.3. This schematic shows the basic flow path of gases through the system that was used for this test, along with the relative locations of the major components, valves, and instruments. Detailed system piping diagrams are provided in Ritter et al. (1998), along with approximate lengths for the piping lines. As seen in Figure 2.3, there are numerous valves in the system that are used to direct the flow to and from the various components. Most of the valves in the system are ball valves and range from 1/4 in. to 1/2 in. nominal size. The system piping is constructed of thin wall tubing (1/4 in. to 1/2 in. OD) and is typically connected using simple Swagelok fittings (tees, elbows, unions, etc.). Ports for gas sampling/analysis and monitoring of system pressure, temperature, and humidity are also provided at key locations in the system piping. Special fittings and pipe-threaded fittings are used in some locations for connecting piping to the process instruments.

Particulate filters are installed in the system on both the inlet and outlet to the retort to help prevent the spread of contamination to the system piping on the outside of the hot cell. These filters are constructed of a microporous fiberglass media in a stainless steel housing. They are 99.9% efficient for particulates that are 0.2 microns and larger in size. Two different size filters, manufactured by Matheson, are used in the system.

2.2.4 System Line Heaters

All of the stainless steel tubing that carries gases into the furnace retort and resultant gases from the retort is heated to about 75°C to ensure condensable water vapor remains in the gas phase. Simple heat "cords" capable of being wrapped upon each other (as required at tees, elbows, and other connections) were found to be a good heating method for this system. The heating cords are controlled by simple proportional controllers, and type-K thermocouples are installed on each heated line so the DACS can be used to monitor and record temperature.

2.3 Process Heating System

The whole element furnace is a 4-ft-long, resistively heated, clam-shell furnace. The furnace, Series 3210 supplied by Applied Test Systems (ATS), has a temperature rating of 900°C and total heating capacity of 13,800 W. The internal dimensions are 5 in. ID by 45 in. long. The furnace has three separate sets of heating elements that allow the heating to be controlled in zones; each zone is 15 in. long and supplies up to 4600 W heating. The zones can be controlled separately to establish a flat temperature profile within the furnace even though heat is lost preferentially out the end with the retort entry flange. A heat reflector consisting of several thin Inconel plates is used to reduce heat loss from the flange end of the retort. The furnace controller is an ATS Series 3000, which consists of three programmable, self-tuning

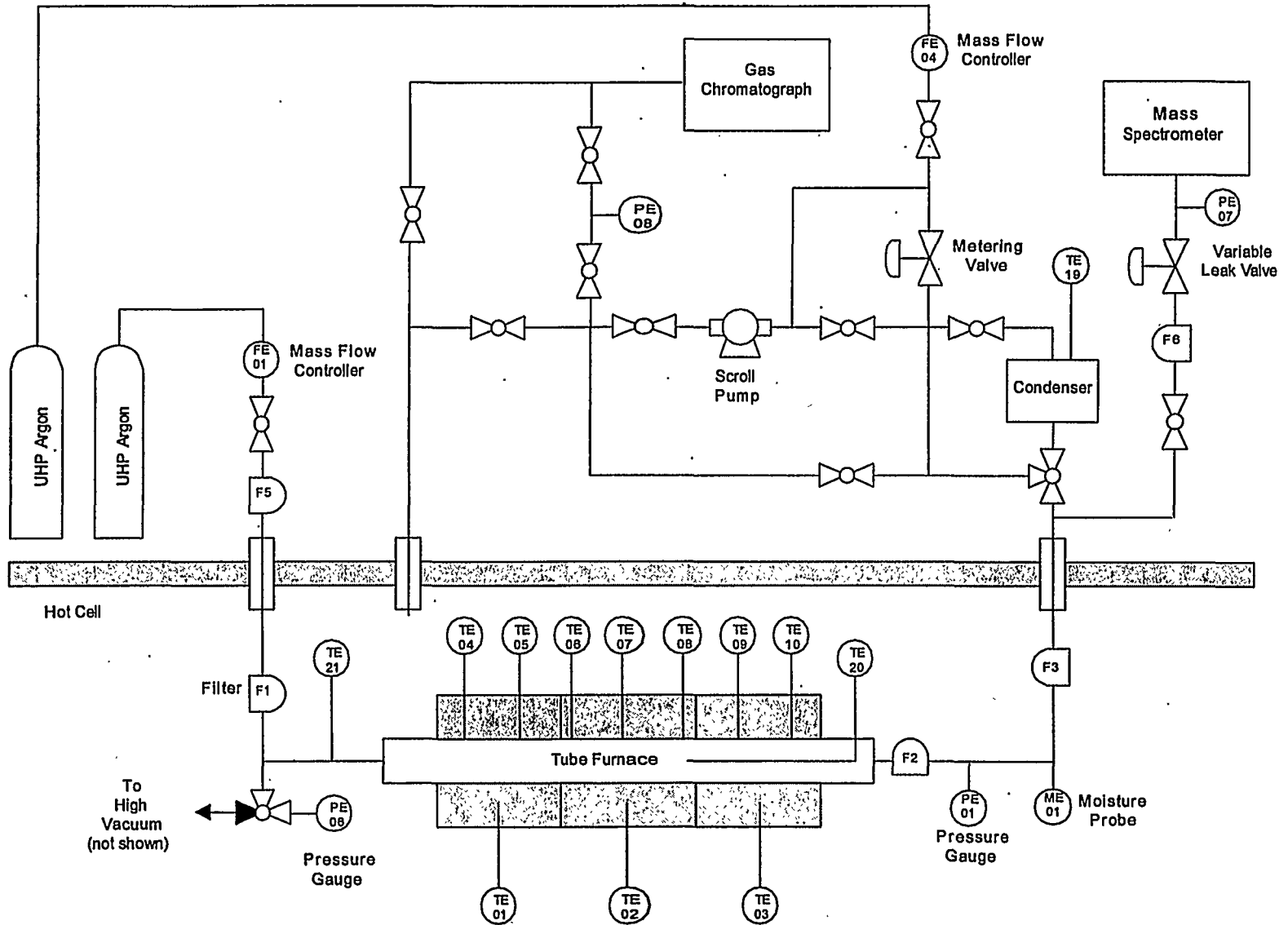

Figure 2.3. Generalized View of the Furnace Testing System

proportional with integral and derivative controllers. These controllers are also interfaced to the DACS, which can provide limited input to the controllers as required.

The retort, an ATS Series 3910, is an Inconel tube fitted with a gas inlet tube at one end and a gasketed flange at the other. Of all high-temperature materials, Inconel series 600 was selected to reduce the amount of oxidation and water pickup by the retort and associated components. Experience has shown that stainless steel components were easily affected by corrosion, which could then affect test results. The body of the retort is fabricated from schedule 40 Inconel pipe (4.5 in. OD, 4.026 in. ID), and the inside length is about 44.5 in. Seven type-K thermocouples are installed equidistant along one side of the retort and extend into the retort interior approximately 1/8 in. These thermocouples are used to monitor the retort temperature so that if a reaction with the fuel element occurs (which would locally raise the retort temperature), this event can be correlated with the approximate location on the fuel.

An Inconel sample/transfer boat is used to load the fuel element into the furnace. The boat is fabricated from an 11-gauge (0.120-in.-thick) Inconel 601 sheet, which is formed into a flattened u-shape. The boat has a weir and a swivel handle on each end. The weirs are used to keep free water or particulates contained in the boat as required.

2.4 Gas Supply/Distribution System

The gas supply system and vacuum pumping system together are capable of controlling the fuel element environment to vacuum or moderate pressure conditions, and/or exposing the fuel element to a variety of gases or gas mixtures. The gas loop is typically operated as a single-pass system with no capability for recirculation. The gas supply system consists of gas bottles; mass flow controllers; piping; and valves for metering argon, air, or oxygen through the system. A bubbler is also available for adding water vapor to the process gas stream as required, but it was not used in these tests.

The gas supply system contains three Matheson mass flow controllers calibrated for argon, air, and oxygen. All gases are typically specified "ultra high purity" and are additionally filtered for water using molecular sieve columns. Argon is the principal inert gas used, as it is more dense than air; provides reasonable thermal conductivity; and requires simpler handling procedures than lighter gases such as helium. The argon purge gas is introduced into the retort through FE-01, which is a Matheson model 8272-0422 oxygen controller, recalibrated for argon gas at 25°C using a NIST-traceable bubble flow meter. The recalibration resulted in a flow rate range of 0 - 324 sccm argon. Air and oxygen are not currently used because any oxidative steps have been deleted from the current IPS for the SNF. The manufacturer's specifications for the air and oxygen controllers' flow rate ranges are 0 - 1000 sccm air and 0 - 10 sccm oxygen. If higher flow rates are desired, a new mass flow controller with a higher range could be procured and installed in the system.

2.5 Gas Analysis Instrumentation

2.5.1 Balzers Omnistar Mass Spectrometer

The Balzers Omnistar Mass Spectrometer is a compact, computer-controlled, quadrupole MS capable of scanning to 300 amu. The unit is capable of monitoring up to 64 components within a gas stream with a nominal detection limit of less than 1 ppm for most gases other than hydrogen. The MS was used to monitor hydrogen, nitrogen (for air in-leakage), krypton, xenon, and other elements during the test.

The MS was modified as a result of early system testing and calibration to improve the time response to small changes in hydrogen pressure. Prior to testing, the MS was calibrated for hydrogen using mixtures of hydrogen and helium, and hydrogen and argon gas. The residence time of each gas could be measured in the quadrupole chamber, and it was observed that the hydrogen decay time was approximately four times as long as helium. This was not unexpected as turbomolecular pumps have a lower pumping efficiency for very light gases. In standard practice this is acceptable, but, for these tests, where determining hydrogen could be very important, steps were taken to improve the hydrogen decay time. The MS vacuum system was modified by adding a stainless steel flanged tee, a gate valve, and a room-temperature hydrogen getter downstream from the quadrupole. Under vacuum the gate valve can be opened, exposing the getter to the system to help scavenge hydrogen from the system following analysis. This modification reduced the residence time of hydrogen in the system substantially and decreased the background level of hydrogen by about a factor of 2. The getter improved the system response to transient events that may result in the release of hydrogen.

A Granville-Phillips variable leak valve, series 203, was added to the gas sampling inlet of the MS in order to permit operation over a wide range of system pressures. Without the leak valve, system pressures above about 40 Torr produce too much flow through the MS capillary tube, which overwhelms the turbo pump used to pump down the MS vacuum chamber. Flow through the leak valve can be continuously varied from 0.4 l/s to 10^{-11} l/s, which allows the MS inlet pressure to be controlled to any pressure desired, even if the system pressure varies dramatically. The pressure on the low-pressure side of the leak valve is measured using a Cole-Parmer sensor (PE-07) and recorded by the DACS. The inlet head pressure is divided by the pressure used for the calibration, and this factor is applied to the test data for calculating actual gas concentrations. The MS was calibrated at ~30 Torr head pressure with a certified gas standard consisting of 1050 ppmv hydrogen in argon.

2.5.2 MTI M200 Gas Chromatograph

The MTI M200 Gas Chromatograph is a high-speed GC that is used to monitor the quantities of hydrogen and other light gases in the furnace testing system gas loop. This instrument is interfaced with a laptop computer to record data. The GC is designed to operate at near-atmospheric pressure; thus it may be configured in two different ways for measurement purposes. At system pressures near atmospheric, the GC is configured to sample directly from the gas loop ahead of the system vacuum pump. When the system is under vacuum, the GC is configured to sample from the exhaust side of the vacuum pump. The gas output from the pump is sufficiently compressed that the GC can sample and analyze this gas. The GC inlet pressure is measured using a Cole-Parmer pressure sensor (PE-08), and recorded by the DACS.

No correction for the difference in the sample pressure and calibration pressure is applied, since both are ~760 Torr (~ 1 atm). The GC was calibrated with a certified gas standard consisting of 114 ppmv hydrogen in synthetic air.

2.6 Process Instrumentation

The furnace testing system contains several process instruments for monitoring moisture content, pressure, and temperature. The key instruments are as follows:

- Panametrics moisture monitor
- MKS Baratron pressure transducers
- Cole-Parmer pressure transducers
- Type-K thermocouples.

2.6.1 Panametrics Moisture Monitor

The Panametrics moisture monitor model MMS35 uses a solid electrochemical probe (model M2L) that measures moisture by measuring the characteristic capacitance of the probe as a function of the moisture in the gas phase. The sensor has a nominal dew point range of -110°C to 20°C. Previous testing indicated that contamination by radioactive elements (e.g., cesium) causes the probe to lose calibration and results in moisture readings that drift with time. To prevent contamination of the probe tip, the probe is installed in the gas loop downstream of two glass particulate filters. Further, the probes are changed following each test and surveyed for radioactive contamination. If no contamination is found, and the data correlate well with the data obtained from the MS, the readings are accepted.

A calibration verification procedure can be performed using calibrated water “leak” tubes. These tubes can be placed inside the furnace and, when heated, will establish a known water vapor pressure in the system. However, this procedure is time intensive; approximately 2 weeks are required to calibrate one probe over the range of moisture likely to be encountered in these tests. This procedure is only used if the moisture monitor results vary widely from the MS data.

Output of the moisture monitor is in dew point in degrees Celsius. For comparison with other test data, these dew point values were converted to water vapor pressure in Torr using the water and ice vapor pressure data shown in Table 2.1. Interpolation of the data was accomplished using a 6th-order polynomial fit to the log of the vapor pressure (VP) versus temperature data. The resulting conversion expression is as follows:

Table 2.1. Water and Ice Vapor Pressure Data Versus Temperature

Dew Point (°C)	Vapor Pressure (VP)		
	(Pa) ^(a)	(Torr)	Log (Torr)
-80	5.5000E-02	4.136E-04	-3.3834
-75	1.2200E-01	9.174E-04	-3.0374
-70	2.6100E-01	1.963E-03	-2.7071
-65	5.4000E-01	4.061E-03	-2.3914
-60	1.0800E+00	8.122E-03	-2.0904
-55	2.0930E+00	1.574E-02	-1.8030
-50	3.9360E+00	2.960E-02	-1.5287
-45	7.2020E+00	5.416E-02	-1.2663
-40	1.2840E+01	9.656E-02	-1.0152
-35	2.2350E+01	1.681E-01	-0.7745
-30	3.8010E+01	2.858E-01	-0.5439
-25	6.3290E+01	4.759E-01	-0.3224
-20	1.0326E+02	7.765E-01	-0.1099
-15	1.6530E+02	1.243E+00	0.0945
-10	2.5990E+02	1.954E+00	0.2910
-5	4.0176E+02	3.021E+00	0.4802
0	6.1129E+02	4.597E+00	0.6625
10	1.2281E+03	9.235E+00	0.9655

(a) CRC Press. 1997. *Handbook of Chemistry & Physics*, 78th edition.

$$VP(\text{Torr}) = \log^{-1} (Ax^6 + Bx^5 + Cx^4 + Dx^3 + Ex^2 + Fx + G) \quad (2.1)$$

where x = the measured dew point (°C) and

$$A = -6.7260 \cdot 10^{-12}$$

$$B = -1.7250 \cdot 10^{-9}$$

$$C = 1.7089 \cdot 10^{-7}$$

$$D = -7.2618 \cdot 10^{-6}$$

$$E = -2.9668 \cdot 10^{-4}$$

$$F = 3.4414 \cdot 10^{-2}$$

$$G = 0.66043$$

2.6.2 MKS Baratron Pressure Transducers

Two MKS Baratron model 690 calibrated pressure transducers coupled with MKS model 270 signal conditioners are used as the primary measurement for the overall system pressure. As shown in Figure 2.3, PE-01 measures the system pressure downstream of the retort outlet, whereas PE-06 measures the system pressure at the retort inlet. PE-01 indicates pressure in the range of 0.1 Torr to 10,000 Torr. The

pressure range of PE-06 is 0.01 Torr to 1000 Torr. PE-06 was installed after the first two fuel element drying tests to provide more accurate measurements than PE-01 for low pressures. PE-06 is therefore considered the primary system pressure measurement. In addition, the 270 signal conditioner procured with PE-06 has a special capability to remotely zero the transducer, which provides more accurate pressure measurements below 1 Torr. An auxiliary high vacuum turbo pump is used to pull the inlet to PE-06 to well below 10^{-4} Torr, so that the transducer can be accurately rezeroed. The 270 signal conditioner used with PE-01 does not have a remote zeroing capability. Both signal conditioners have analog outputs that are interfaced to the DACS so that system pressure is continuously recorded.

2.6.3 Cole-Parmer Pressure Transducers

Two Cole-Parmer model H-68801-53 diaphragm-type, calibrated pressure transducers are installed on the MS and GC sample lines, as indicated by PE-07 and PE-08 in Figure 2.3. These pressure measurements are used to normalize the MS and GC data so that actual gas concentrations in the system can be calculated from the relative concentrations measured. These sensors have a range of 0 to 1500 Torr with a resolution of 0.1 Torr, and an accuracy of $\pm 1\%$ or ± 1 Torr, whichever is larger. Both readout units (model H-68801-03) have analog outputs that are interfaced to the DACS so that these pressures are continuously recorded.

2.6.4 Thermocouples

Thermocouples provide a simple, reliable method for measuring system temperatures. As shown in Figure 2.3, over 20 thermocouples are installed at various locations in the system to provide key temperature measurements. The retort temperatures are of primary importance, and these temperatures are measured by thermocouples TE-04 through TE-10, which are positioned equidistant along the length of the retort. Other key temperature measurements include the retort center temperature (TE-20, which is a 30-in.-long thermocouple installed through the outlet end of the retort), retort inlet temperature (TE-21), condenser gas temperature (TE-19), and the condenser coolant temperature (TE-22). Thermocouples TE-11 through TE-17 are used for controlling the temperature of the heated lines. All thermocouple readings are continuously recorded using the DACS.

2.7 Data Acquisition and Control System

The DACS monitors system parameters, and controls the furnace and the safety argon system. The DACS consists of a Hewlett Packard (HP) 3497A data acquisition/control unit and an IBM-compatible computer. A National Instruments general purpose interface bus card, installed in the IBM-compatible computer, is used to communicate with the HP 3497A. The computer communicates with the furnace temperature controllers over serial port 0 using an RS-232/RS-485 converter. The DACS uses National Instruments LabView for Windows as the control software.

The DACS is designed to measure critical system parameters during fuel conditioning tests, including temperatures, pressures, flow rates, and moisture level. The measured parameters are converted to engineering units, displayed on the computer screen, and stored to disk at user-defined intervals. The data

files are stored in a tab-delimited format to allow importing into a standard spreadsheet or plotting program. A plotting screen also allows for plotting of up to six parameters at a time.

Limited control of the furnace can be performed with the DACS. Each of the three furnace zone temperatures can be remotely set by the DACS. In addition, the DACS allows the operator to start and stop the furnace and select one of four temperature profiles that are pre-programmed in the furnace temperature controllers. Note that these profiles must be programmed manually in the furnace controllers before using the DACS to select them.

3.0 Furnace Testing

The test was performed in accordance with the requirements of *Test Plan for Whole Element Furnace Runs 1, 2, and 3*, SNFCT97:053:R00, and the individual Test Procedure, *Postirradiation Testing Laboratory Work Plan for Furnace Testing*, 327-RS-97-018, Rev. 0. These documents are located in the PNNL permanent project records for this test.

The testing consisted of two parts (discussed in this section):

- drying the system using a combination of Cold Vacuum Drying (CVD) and Hot Vacuum Drying (HVD) processes
- cooling the furnace, and returning the system to a state ready for whole fuel element testing.

3.1 Initial Conditions

No water was added to the sample boat. The test conditions used were otherwise the same as those used for fuel element 3128W (Run 2).

The empty test apparatus was subjected to cold and hot vacuum drying. The testing was conducted in six phases:

1. Cold Vacuum Drying
2. Pressure Rise Test
3. Gas Evolution Test
4. Hot Vacuum Drying (first step)
5. Hot Vacuum Drying (second step)
6. Water Removal Verification.

The conditions used for these test phases are summarized in Table 3.1. Each phase is described below.

3.1.1 Cold Vacuum Drying

Air was first introduced into the furnace by allowing the ambient hot cell air to flow into the retort. The furnace temperature was then raised to about 50°C and allowed to stabilize. The system vacuum pump was then turned on. Since no water was added to the system, the condenser was not used for this dry-run test.

The vacuum pump is capable of reducing the system pressure to levels lower than desired for simulating the CVD process. To stabilize the system pressure near the desired value of about 5 Torr, dry,

Table 3.1. Summary of Test Conditions

Test Segment	Test Conditions for First (Dry) Dry-Run
A. Cold Vacuum Drying System Configuration Test Temperature, °C Atmosphere Pressure, Torr Gas Flow Rate, cc/min Gas Species Monitored Duration, hr	Normal ~50 Vacuum, Ar background <5 ~50 H ₂ , H ₂ O, N ₂ , O ₂ , CO ₂ , Ar, Kr, Xe The duration for CVD was at least 2 hr or until free water being removed read either background or below detectable limits.
B. Pressure Rise Test System Configuration Test Temperature, °C Atmosphere Initial Pressure, Torr Gas Species Monitored Pressure Rise (acceptable levels, Torr) Duration, hr	Test Chamber Isolated ~50 Vacuum, Ar background <5 H ₂ , H ₂ O, N ₂ , O ₂ , CO ₂ , Ar, Kr, Xe 0.5 3
C. Gas Evolution Test System Configuration Test Temperature, °C Atmosphere Initial Pressure, Torr Gas Species Monitored Pressure Rise (acceptable levels, Torr) Duration, hr	Test Chamber Isolated 75 Argon 760 (~atmospheric) H ₂ , H ₂ O, N ₂ , O ₂ , CO ₂ , Ar, Kr, Xe <120 12
D. Hot Vacuum Drying (Step 1, heatup) System Configuration Test Temperature Range, °C Temperature Ramp Rate, °C/hr Atmosphere Pressure, Torr Gas Flow Rate, cc/min Gas Species Monitored Duration, hr	Normal ~75 to 300 10 Argon 760 (~atmospheric) ~300 H ₂ , H ₂ O, N ₂ , O ₂ , CO ₂ , Ar, Kr, Xe ~24
E. Hot Vacuum Drying (Step 2, drying) System Configuration Test Temperature, °C Atmosphere Pressure, Torr Gas Species Monitored Duration, hr	Normal ~300 Vacuum, Ar background <5 H ₂ , H ₂ O, N ₂ , O ₂ , CO ₂ , Ar, Kr, Xe ~48

Table 3.1. (contd)

Test Segment	Test Conditions for First (Dry) Dry-Run
F. Water Removal Verification	
System Configuration	Normal
Test Temperature, °C	400
Temperature Ramp Rate, °C/min	1
Atmosphere	Vacuum, Ar background
Gas Species Monitored	H ₂ , H ₂ O, N ₂ , O ₂ , CO ₂ , Ar, Kr, Xe
Duration, hr	~10

UHP argon was metered into the system. CVD was conducted at about 6.5 Torr (total system gas pressure) for 66 hr. The flow of UHP argon through the furnace system also minimized in-leakage of cell air into the retort tube.

3.1.2 Pressure Rise Test

The Pressure Rise Test involved isolating the system from the effects of flowing gas, and continued vacuum pumping and measuring any system pressure increases while at CVD pressure and temperature conditions. This test was conducted by valving the vacuum pump out of the gas loop, turning off the argon gas flow, and closing the exhaust valves in the gas loop. This test was conducted over a period of about 3 hr.

3.1.3 Gas Evolution Test

This test was conducted at ~80°C in a background of UHP argon gas at nearly 1 atm total system pressure. This test was performed by simultaneously increasing the system pressure and temperature to the test conditions. The system pressure was elevated by metering UHP argon gas into the system until the desired pressure was reached. The gas flow was then turned off and the fuel element isolated for ~20 hr at the conditions specified in Table 3.1. Since this test was conducted under static conditions, moisture accumulated in the retort during this test segment.

3.1.4 Hot Vacuum Drying, Step 1

The first step of HVD involved heating the fuel element from ~75°C to ~310°C at a ramp rate of 10°C/hr in a flowing argon atmosphere near 1 atm system pressure. UHP argon was allowed to flow through the system at ~324 cc/min and exhausted to the hot cell. This portion of the test took about 24 hr.

3.1.5 Hot Vacuum Drying, Step 2

The second part of the HVD test cycle required the system be evacuated to about 5 Torr while the temperature was held at ~310°C. Again, argon gas was metered into the system to establish the vacuum conditions in the test system. The second step of the HVD process was conducted for about 6 hr.

3.1.6 Water Removal Verification

During fuel element drying, hydrogen may be released from the fuel through decomposition of UH_3 , which occurs at $\sim 265^\circ\text{C}$. Water also may be liberated by various hydrated species found on fuel elements. Thus, to check for the presence of hydrogen and water that are released at high temperature, which are not attributable to decomposition of UH_3 and uranium oxy-hydrates (when a fuel element is tested), the system was heated to 400°C . The test was conducted under vacuum for about 12 hr with argon metered into the system as the background gas.

3.2 Calculation of Water and Hydrogen Inventories

Assuming ideal gas behavior of the water vapor, the total water inventory (in grams) in the system during those portions of the test conducted with argon flowing into the retort tube can be approximated from the measured water vapor pressure and the argon gas flow as follows:

$$\frac{dm}{dt} = \frac{M}{V_0} \frac{P_w}{(P_t - P_w)} \frac{dV}{dt} \quad (3.1)$$

where dm/dt is the rate of water removal in grams per minute, M is the molecular mass of water in grams per mole, dV/dt is the flow rate in liters per minute (at the calibration temperature of 25°C), V_0 is the molar volume of gas at 25°C and 1 atmosphere in liters per mole, P_w is the partial pressure of water vapor in Torr, and P_t is the total pressure in Torr. The total amount of water released is given by integrating the rate data over time.

The hydrogen inventory may be calculated in a similar fashion with the $[P_w/(P_t - P_w)]$ expression in the above equation replaced with the measured atom fraction of hydrogen. For the purposes of this report, all hydrogen data are reported in Torr-l rather than grams. At the calibration conditions of the argon flow controller, 1 Torr-l is equivalent to approximately 0.11 mg of hydrogen.

The assumptions made in estimating the water and hydrogen values are:

- The flow into the retort is approximately equal to the flow out.
- The argon mass flow is referenced to 25°C .
- The sample gas is at the same temperature as the calibration gas (GC and MS measurements).

4.0 Experimental Results

In the following sections, the experimental data collected during the drying test are expanded and plotted for each segment. Summary results from the test are plotted in Figure 4.1. This figure shows the system moisture level response to the pressure changes and the retort tube temperatures during the test. Time intervals for the various test segments are shown in the upper section of the plot, and also are outlined in Table 4.1. The temperatures shown in Figure 4.1 were recorded from one of seven thermocouples (TE-07) on the system located near the center of the retort.

4.1 Cold Vacuum Drying

The water released during the CVD portion of the test is shown in Figure 4.2. The baseline moisture partial pressure in the system prior to heating was ~10 Torr. This moisture pressure was below the theoretical saturation vapor pressure for the argon/air gas mixture (residual air from when the fuel element was loaded) at ~21°C. The saturation pressure at this temperature is about 20 Torr, yielding a relative humidity of about 50% in the system. The moisture pressure decreased from the baseline to about 0.2 Torr when the system was first evacuated to ~5 Torr and heated to ~50°C.

The total pressure of the closed system also increased from 753 Torr to 813 Torr when the temperature was increased from 20.3°C to 49.3°C. Theoretically, for an ideal gas, the expected pressure rise due to a temperature increase from 20.3°C to 49.3°C is 74 Torr, approximately 14 Torr greater than the measured pressure rise. This difference in pressure rise was most likely due to small differences in the temperature in different parts of the system such as the volume of gas in the unheated end of the retort. The moisture trace in Figure 4.2 shows that the desorption of the moisture correlates well with increasing temperature; the moisture removal rate drops quickly after the system reaches about ~50°C and argon flow is established.

Figure 4.2 also shows that the moisture pressure reached a maximum of about 10 Torr. The temperature plot indicates the retort tube had not reached the 50°C setpoint temperature before the system was evacuated. Evacuating the system with the water condenser and scroll pump resulted in a decrease in the total pressure as well as in the partial pressure of moisture. The decrease in the total pressure was more rapid than the decrease in the moisture pressure. The slight system pressure increase shown as a step in Figure 4.2 was due to the introduction of argon gas into the system to provide a controlled background atmosphere of about 5 Torr.

The slow decrease in the moisture partial pressure at the end of the CVD indicates that the total CVD time of 66 hr was sufficient to remove nearly all the *free* (i.e., not chemically bound) water from the system. System moisture pressure was 0.23 mTorr at the end of CVD. Water removed during the latter stages of CVD, after the condenser phase, when there was argon flow, was calculated to be ~40 mg.

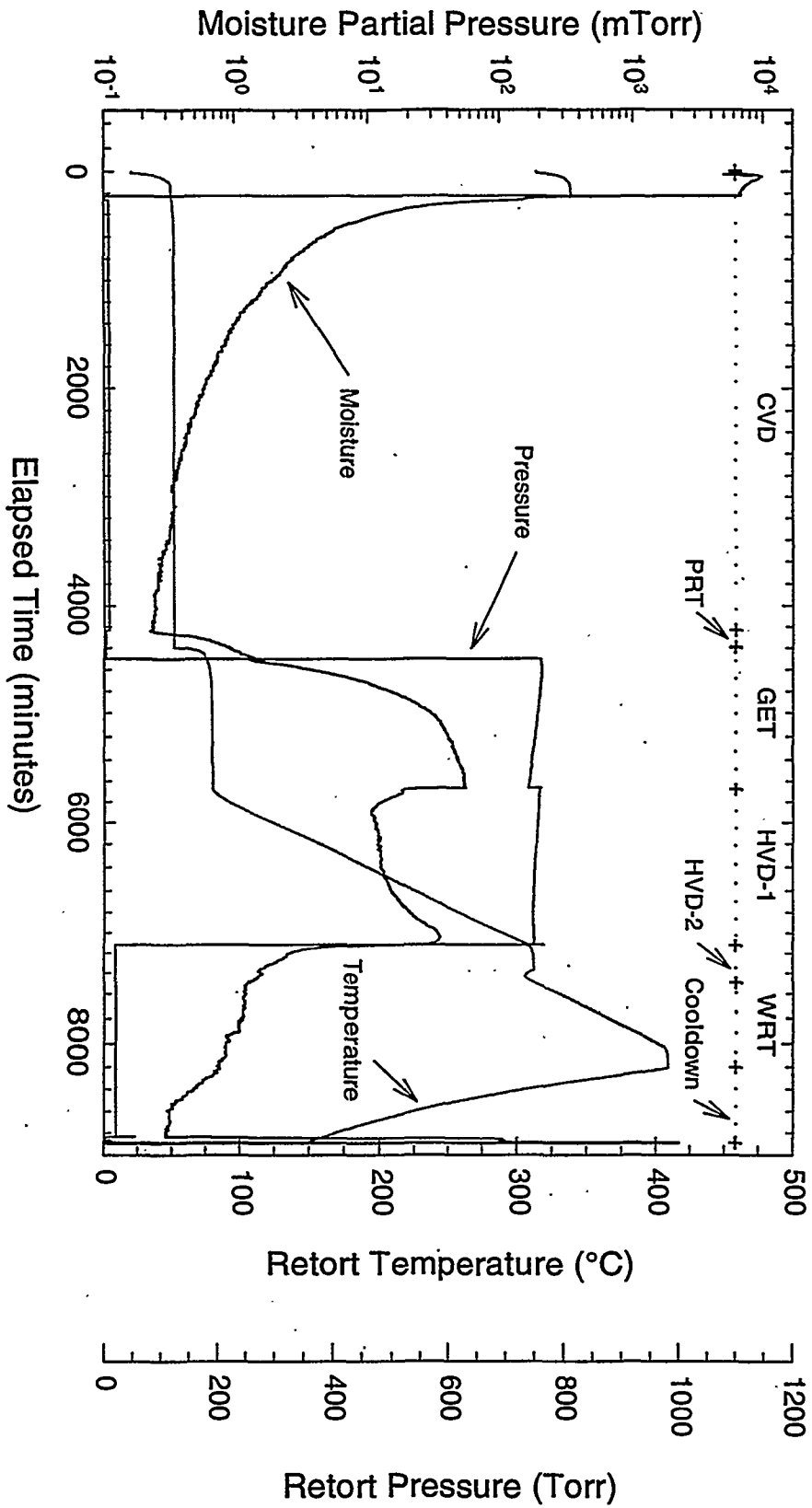

Figure 4.1. First Dry-Run Test, Summary Plot

Table 4.1. First Dry-Run Time Line

Activity	Date/Time	Elapsed Time (min)
Start of Test		
Heat furnace to ~50°C	11/14/97 10:38	15
Cold Vacuum Drying Test		
Open pump valve and condenser to furnace	11/14/97 14:09	226
Close pump valve	11/14/97 14:47	261
Open pump valve, close condenser valve		
Start Ar flow to attain a retort pressure of ~5 Torr	11/14/97 14:47	264
Pressure Rise Test		
Close pump and Ar flow valves (isolate furnace)	11/17/97 8:55	4233
Gas Evolution Test		
Raise furnace temperature to 75°C	11/17/97 11:35	4393
Start Ar flow at ~300 cc/min	11/17/97 13:21	4499
Stop Ar flow when furnace pressure reaches ~1 atm (~760 Torr)	11/17/97 13:23	4501
Hot Vacuum Drying Test (Step 1)		
Raise furnace temperature to 300°C @ 10°C/min		
Start Ar flow at ~300 cc/min (vent to cell)	11/18/97 9:03	5681
Hot Vacuum Drying Test (Step 2)		
Hold furnace temperature and Ar flow rate		
Open pump valve	11/19/97 8:58	7116
Water Removal Verification		
Raise furnace temperature to ~400 °C	11/19/97 15:14	7492
Turn off furnace heaters, end test	11/20/97 3:07	8205

4.2 Pressure Rise Test

The Pressure Rise Test results are shown in Figure 4.3. A linear fit to the total pressure data yielded a total pressure rise rate of ~0.046 Torr/hr. The stepped and noisy appearance of the data is due to under-sampling of the Baratron pressure gauge output and resolution limitations with the 0 to 1000 Torr Baratron sensor. [The number of significant figures that the software records was increased for subsequent tests.] The partial pressure of the moisture in the system also increased linearly with time, as indicated by the regression line shown in Figure 4.3. The rate of water vapor pressure increase was ~0.27 mTorr/hr.

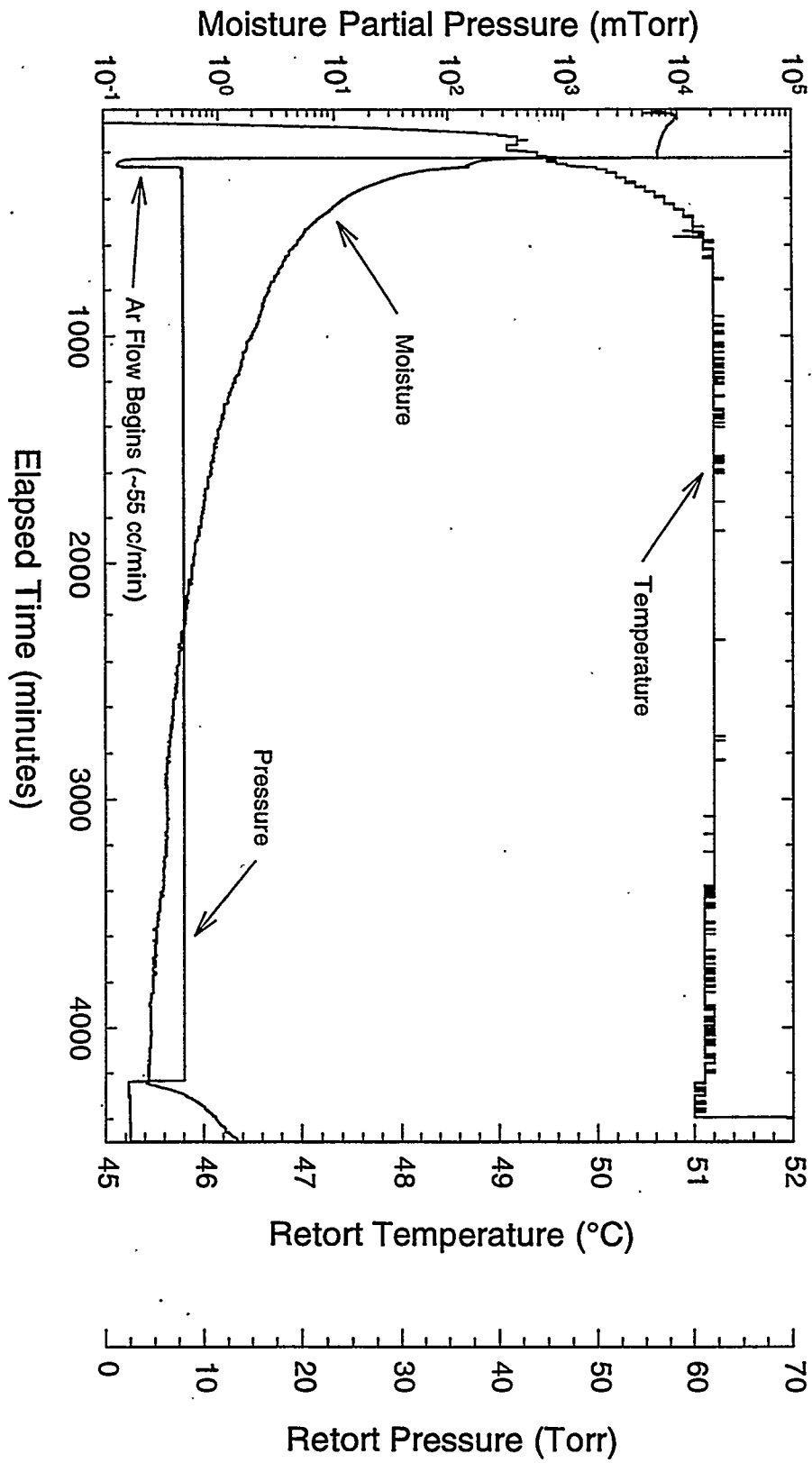

Figure 4.2. First Dry-Run Test, CVD in Vacuum

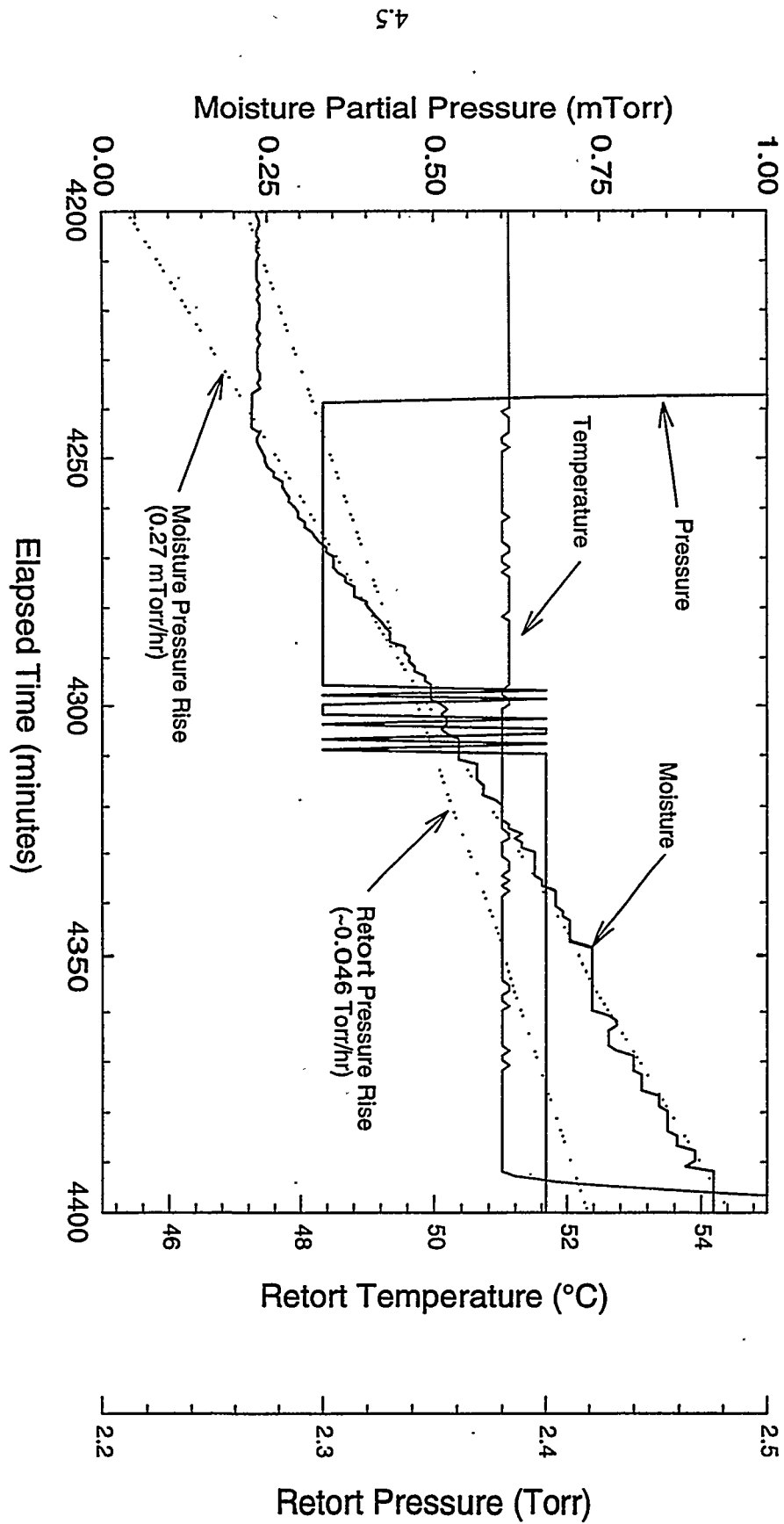

Figure 4.3. First Dry-Run Test, Pressure Rise in Vacuum

Assuming that the water vapor pressure increase is from water sources within the test system, and assuming ideal gas behavior of the water vapor, the rate of desorption of the water will be constant, given by:

$$\frac{dn}{dt} = \frac{V}{RT} \cdot \frac{dp}{dt} \quad (4.1)$$

where n is the number of moles of gas, V is the volume of the system ($\sim 10,000 \text{ cm}^3$), R is the gas constant ($82.06 \text{ cm}^3 \cdot \text{atm} / \text{g} \cdot \text{mol} \cdot \text{K}$), T is the temperature ($\sim 326 \text{ K}$), and dp/dt is the rate of change in the pressure given by the slope of the regression line. The total amount of water released to the system during the Pressure Rise Test is given by the integral of the above equation. For a period of 150 min, the total amount of water released was ~ 6 micrograms. Using a total surface area of $\sim 6670 \text{ cm}^2$ for the system, and 10^{15} atoms per cm^2 as the monolayer gas density on surfaces, ~ 0.03 monolayer equivalents of H_2O were evaporated.

Given the linearity of the water pressure increase, and the very small quantity of moisture evolved, air leakage into the system could also account for most of the observed water pressure rise. Assuming that the total pressure rise of $\sim 0.046 \text{ Torr/hr}$ is from air in-leakage, the observed water pressure rise of $\sim 0.27 \text{ mTorr/hr}$ would indicate a water fraction in the air of $\sim 0.6\%$, or a relative humidity of $\sim 25\%$ at 20°C . These conditions would be close to that expected in the PTL.

4.3 Gas Evolution Test

Figure 4.4 shows the increase in moisture partial pressure during the Gas Evolution Test at a furnace temperature of approximately 80°C . The release of moisture occurs over three regions. The initial portion of the heatup period, which was conducted under vacuum condition, showed negligible rise in the moisture. This is likely due to the slow response of the various system elements to the retort temperature ramp. This first region was followed by a more rapid increase in the water vapor pressure, likely from slow heating of the system to the 80°C setpoint. The final region of pressure rise shows a steady slowing down of the moisture release (although still increasing), reaching equilibrium in the final stages of the test at a pressure of $\sim 50 \text{ mTorr}$. The average rate of pressure rise in this final region (prior to equilibrium) was $\sim 2 \text{ mTorr/hr}$. This rate is higher than that determined for the pressure rebound test at $\sim 50^\circ\text{C}$, suggesting a temperature-activated desorption process for the water release.

4.4 Hot Vacuum Drying

The HVD step 1 segment of the test, shown in Figure 4.5, includes the ramp from 80°C to 310°C in flowing argon gas (324 cc/min) at atmospheric pressure. The moisture pressure accumulation ended and decreased rapidly from 50 mTorr to about 17 mTorr once the gas flow was established in the system. This decrease in pressure was followed by a very slight increase when the system temperature exceeded 80°C . This slight increase may be an indication of a different source of moisture, perhaps from release

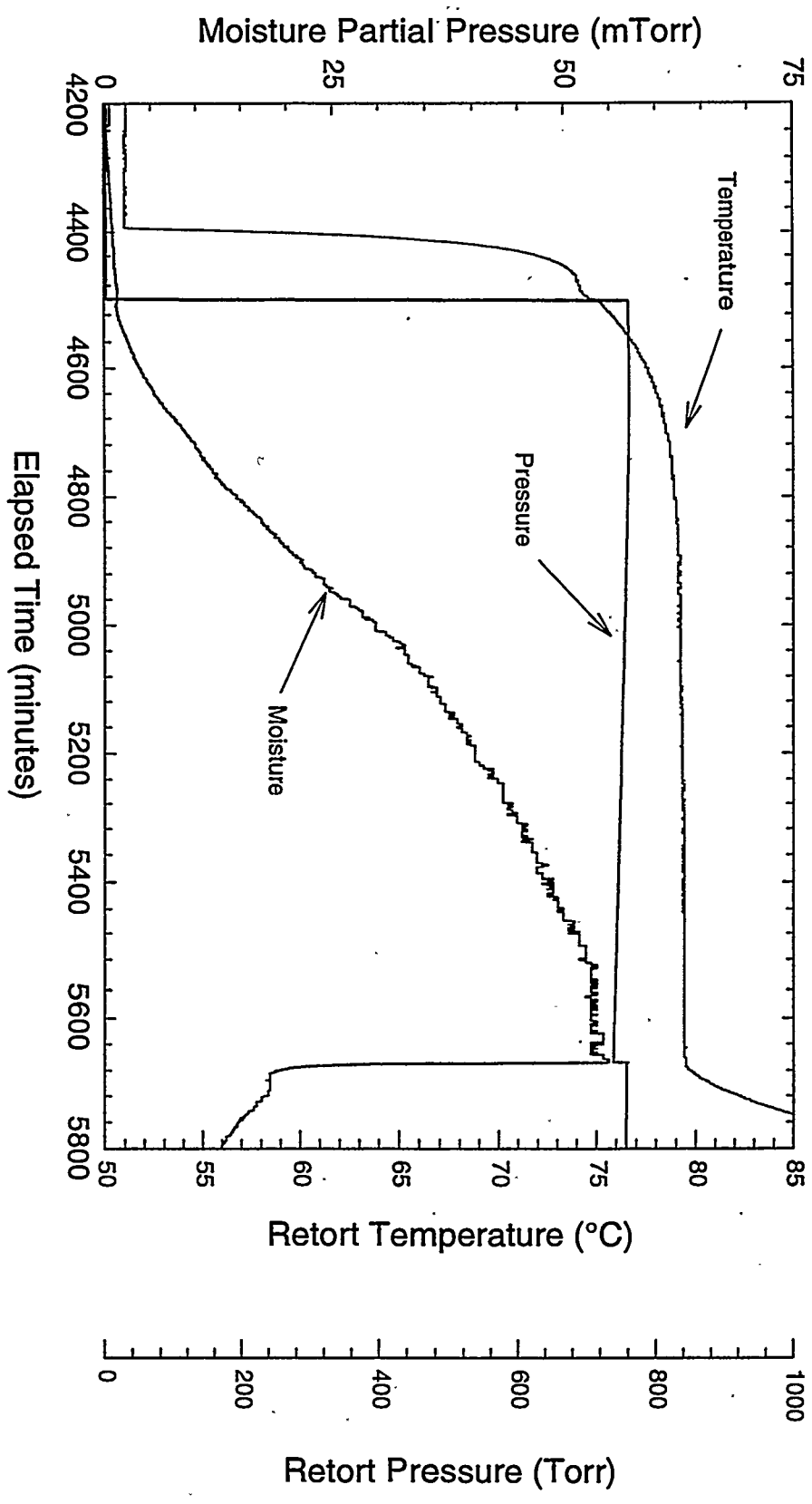

Figure 4.4. First Dry-Run Test, Gas Evolution Test

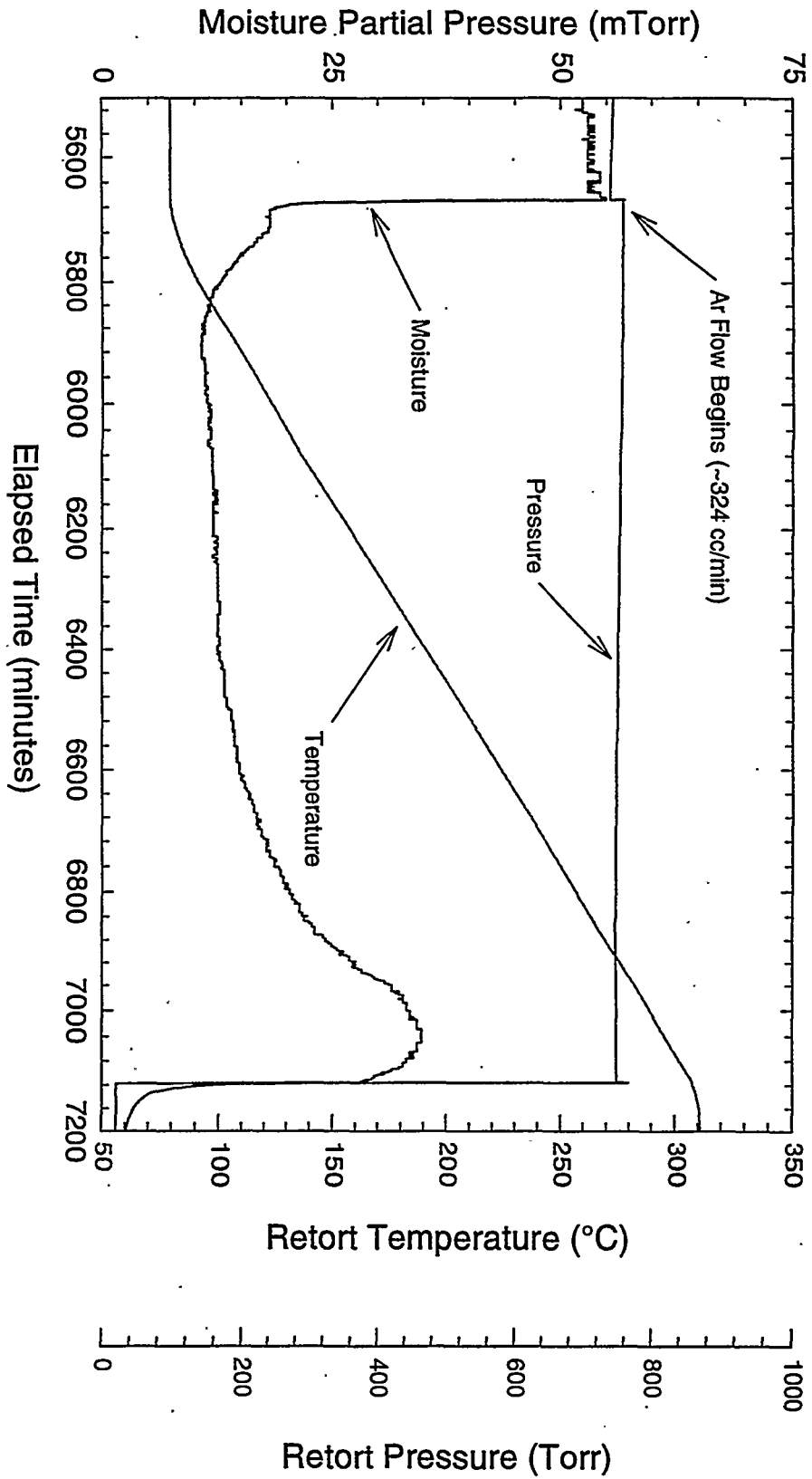

Figure 4.5. First Dry-Run Test, Hot Vacuum Drying - Step 1

from a chemisorbed site (i.e., hydrated species) at higher temperatures. The water released remained constant until the system temperature reached approximately 200°C, where it began to rise, peaking at ~30 mTorr at ~290°C. This second rise is again likely due to desorption of water from a chemisorbed site such as the particulate filter material or elastomers (gaskets, O-rings). The overall level of water release during temperature rise was low.

Figure 4.6 shows the HVD step 2 test segment. Clearly, removing moisture from the system by the vacuum pump is more effective than only flowing gas through the system. The moisture pressure decreased sharply from about 25 mTorr to ~1 mTorr when the system was again evacuated. This was followed by a slow decrease for the remaining time of the HVD test segment. It should be noted that the HVD was conducted at a temperature near 310°C.

The data from the HVD suggest slow release kinetics of the moisture indicative of decomposition from chemically bound water. The slow decrease of the moisture level suggests that thermal decomposition of the hydrated species and/or removal of water dissolved in elastomers kinetically control the water removal process. Total water removed during the HVD portion of the test was approximately 36 mg. This compares with the ~40 mg removed during CVD.

4.5 Water Removal Verification

This last segment of the test was conducted to determine if there was any moisture remaining in the system following HVD. Figure 4.7 shows the moisture response to the final temperature ramp to 410°C. The moisture release rate continued to decrease at a nearly exponential decay rate with increase in temperature, indicating that essentially no water remained in the system. No significant water release peaks were observed.

4.6 Mass Spectrometer Measurements

The Balzers Omnistar MS was to be used to collect hydrogen and other gas release data over the test run. For periods of time when the furnace system was at atmospheric pressure, the MS variable leak valve had to be used because the inlet pressure to the MS was too high to allow operation of the system to sample the gas directly. The level of hydrogen in the system was too low to quantify accurately using the MS.

Data collected during the portions of the test conducted at vacuum (e.g., CVD, and HVD steps 1 and 2) proved to be so low as to be within the background level of the MS quadrupole detector. Additionally the pressurization of the system after CVD, and subsequent depressurization after HVD step 1, complicated the data analysis of the MS signals. As a result, meaningful concentration data were not obtained for the release of hydrogen or fission gases. Thus, data for hydrogen throughout the HVD process are difficult to interpret due to the dramatic changes in the inlet pressure to the MS. It should be noted, however, that the general shape of the hydrogen release during CVD was very close to that obtained on the GC. It can also be noted that no significant krypton or xenon release events were observed.

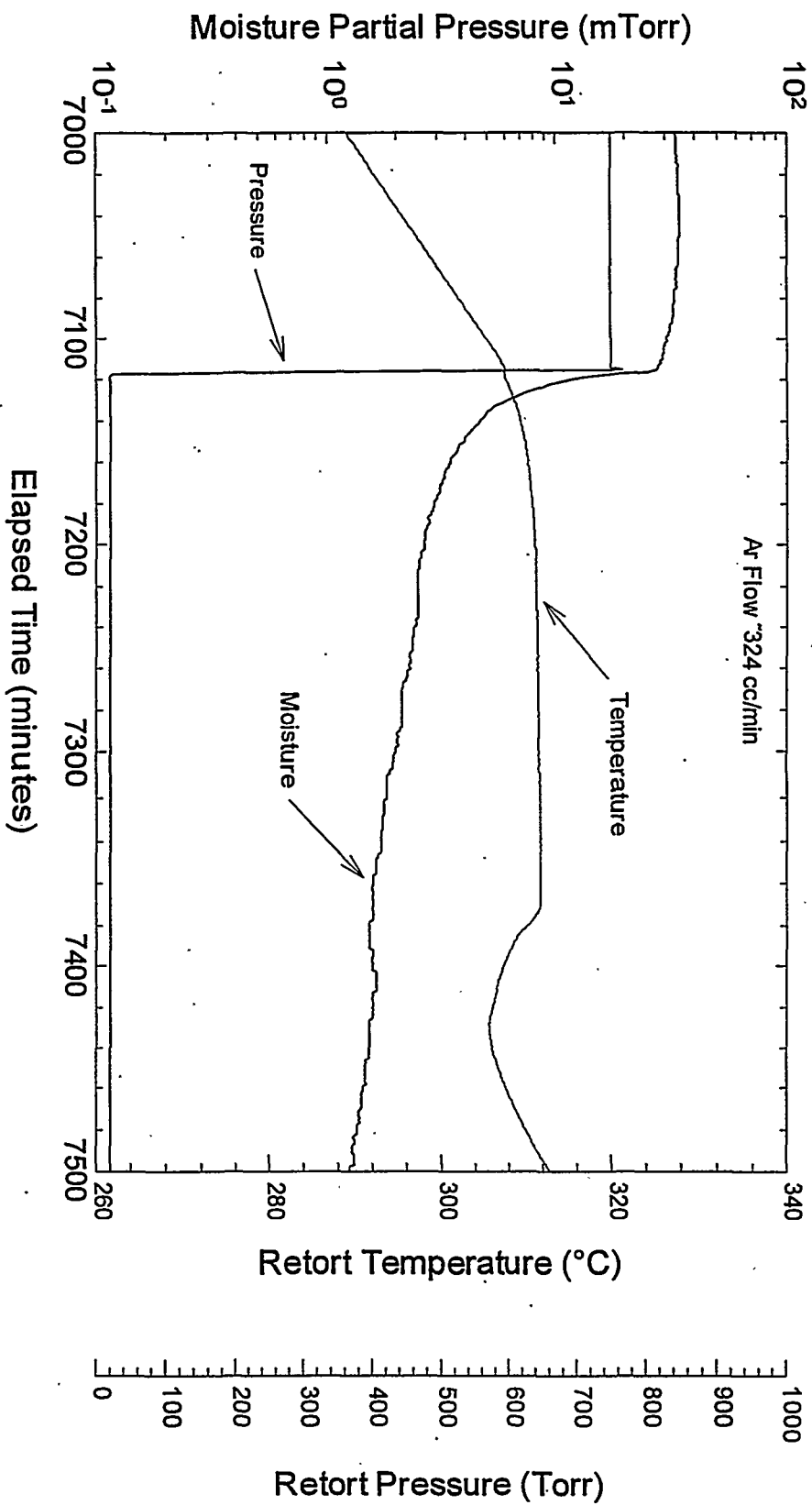

Figure 4.6. First Dry-Run Test, Hot Vacuum Drying - Step 2

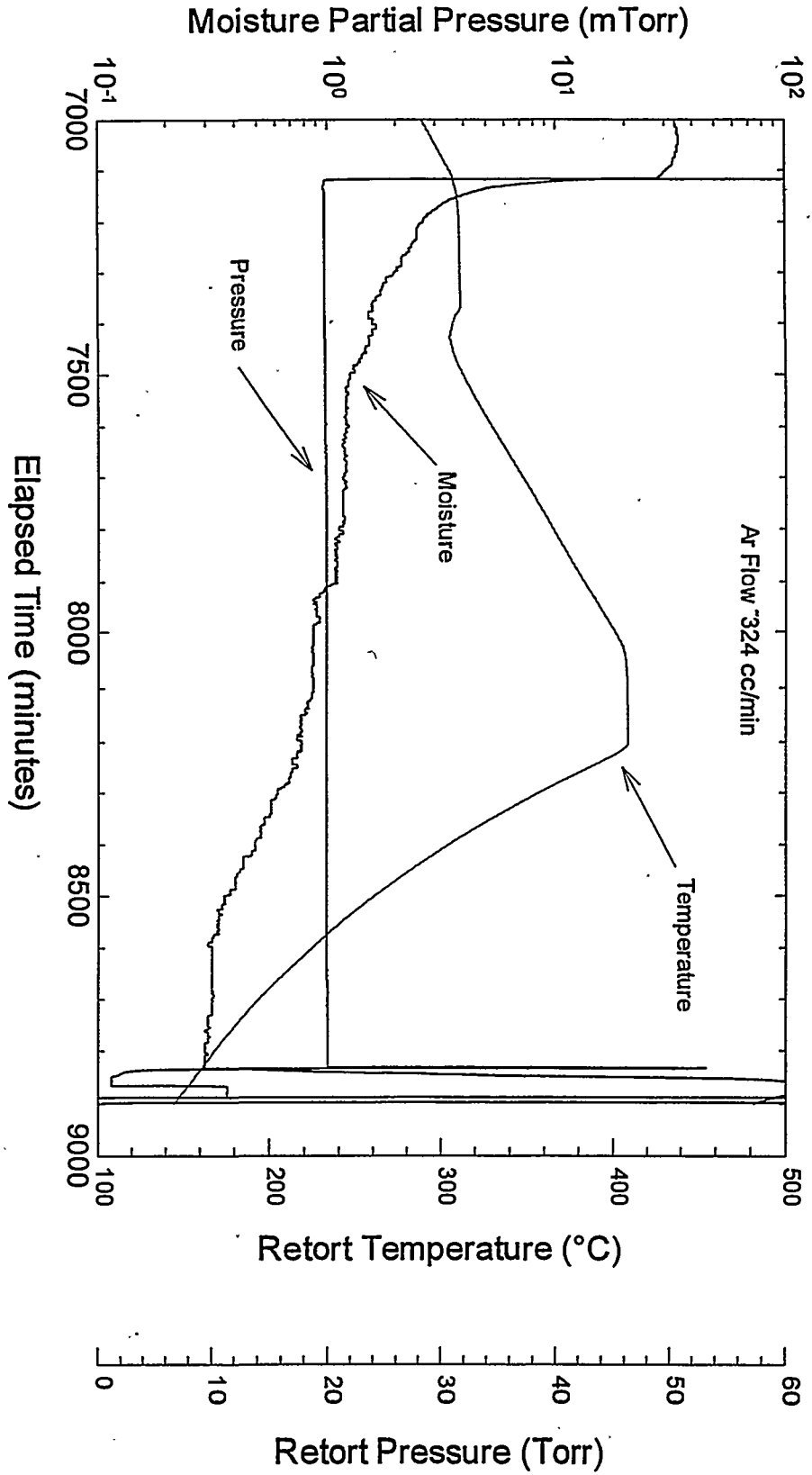

Figure 4.7. First Dry-Run Test, Water Removal Test

4.7 Gas Chromatograph Measurements

The GC is calibrated to measure hydrogen in the sample gas. As discussed earlier, the hydrogen concentration is converted from ppmv to Torr-l so that the absolute quantity of hydrogen gas released can be determined independent of argon flow rate. The GC yielded data for the release of hydrogen in the gas stream during CVD and HVD. During these periods, argon was flowing through the system at a rate of about 55 cc/min (CVD) and 324 cc/min (HVD), respectively. It was not possible to sample for hydrogen using the GC during the Gas Evolution Test, since it was conducted with no flow of argon gas.

Figure 4.8 shows the hydrogen concentration as a function of time in the gas stream together with plots of temperature and moisture partial pressure also as a function of time during CVD. The moisture level in the gas stream varied from 0.3 to 410 mTorr during CVD, whereas the hydrogen level was constant at ~ 0.002 Torr-l (0.003 Torr-l/hr) over the period. Total hydrogen release during CVD was ~ 2.0 Torr-l.

In the HVD test, the lowest temperature at which hydrogen was measured was about 180°C . Hydrogen continued to evolve at an increasing rate with increasing temperature to a level of ~ 0.009 Torr-l, as seen in Figure 4.9. When the maximum ramp temperature of 410°C was reached, the level of hydrogen began to decrease slowly with time. Total hydrogen release during HVD step 2 and Water Removal Verification was ~ 2.2 Torr-l.

The expected sources of hydrogen are from release from the metal in the retort and also hydrogen generated by the decomposition of water with the metal surfaces in the system. Decomposition of metal hydrides is not a likely source of hydrogen in this particular test, as no significant changes in the slope of the hydrogen release curve were observed as a function of temperature. The data, therefore, do not indicate that any metal hydrides were decomposed. Hydrogen dissolved on metal surfaces seems to be the most plausible source.

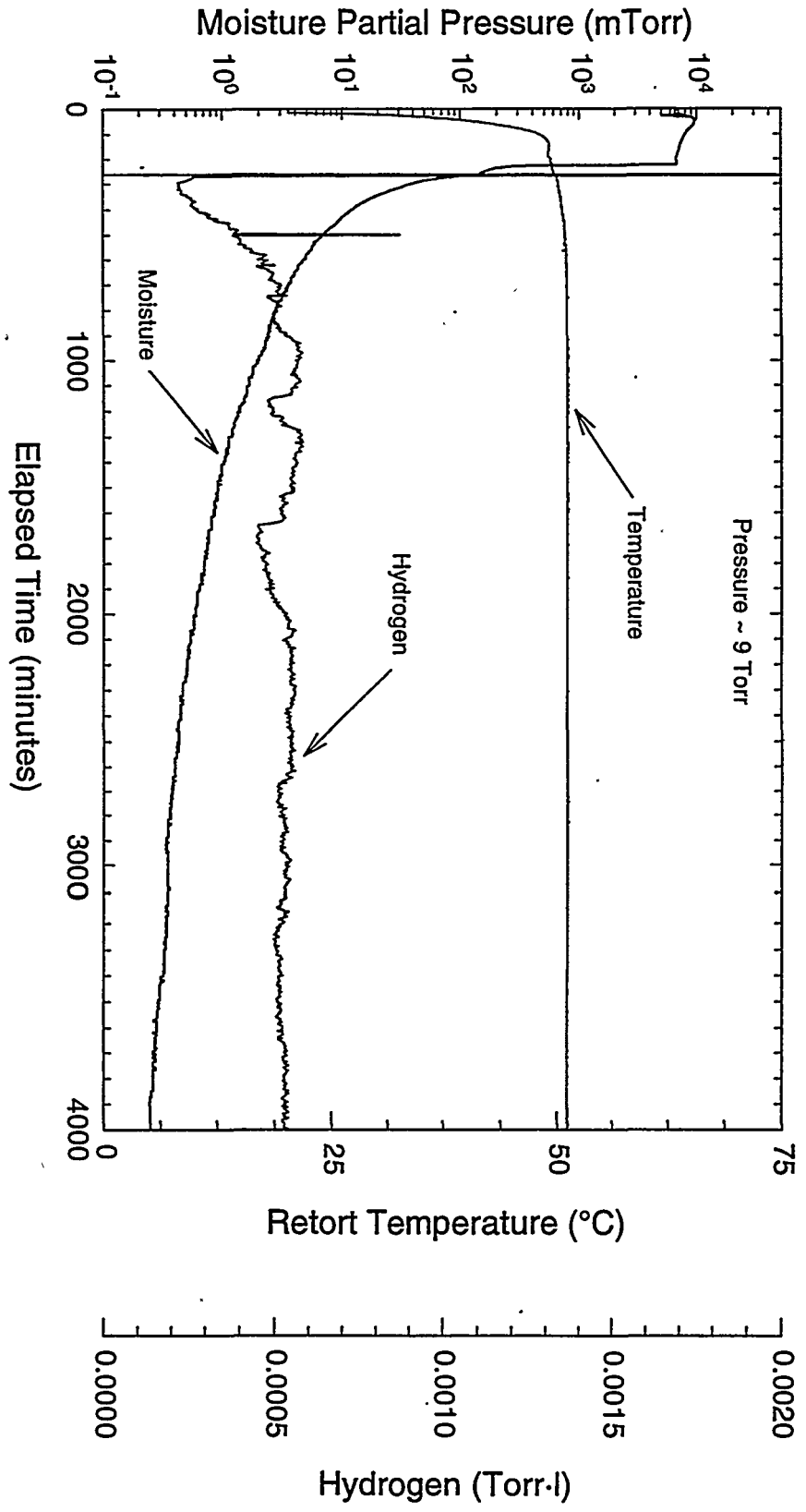

Figure 4.8. Hydrogen Release During CVD

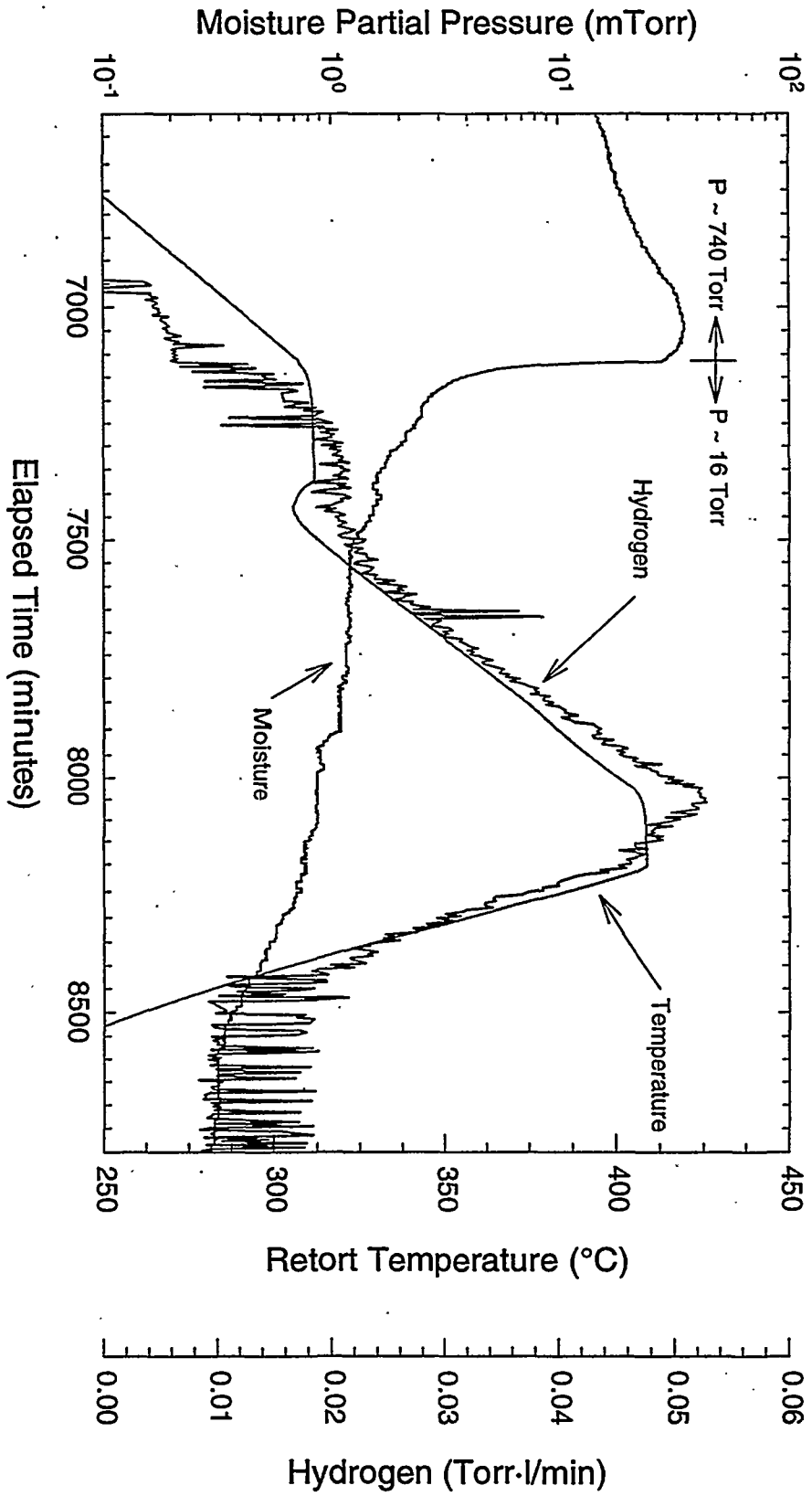

Figure 4.9. Hydrogen Release During HVD

5.0 Discussion

The increase in total pressure during initial static system conditions was due to temperature effects. The total moisture pressure detected was ~10 Torr, which accounts for about one half of the ~20 Torr pressure predicted for saturated gas at 21°C, or a relative humidity of ~50 %. The furnace system was opened to the hot cell atmosphere initially, which had the effect of increasing the moisture level in the retort tube. Therefore, the total free water (i.e., not chemically bound) in the system at the beginning of the drying test was from the following sources:

- water in the gas stream due to the hot cell air mixing with gas in the system
- adsorbed/dissolved water in elastomers such as O-rings and gaskets
- adsorbed/absorbed water on the surface of the retort tube and boat.

Removal of free water from the test system retort was essentially completed within the CVD drying period. During the subsequent Pressure Rise and Gas Evolution Tests, however, small but measurable amounts of water were detected by the moisture probe. Final vapor pressure at the end of CVD was ~0.25 mTorr. The remaining free water was removed from other parts of the test system at temperatures above ~50°C. Water removed during the latter stages of CVD (after the condenser phase, when there was argon flow) was calculated to be ~40 mg.

The Pressure Rise Test in vacuum showed a linear pressure rise with time at constant temperature for both the total pressure and water vapor pressure. The moisture release kinetics are independent of concentration of moisture in the system (i.e., a zeroth order reaction). The atmosphere of the system was very removed from saturation, providing an unlimited sink for water molecule release. The linear release, and the small quantity of moisture evolved, suggests either air in-leakage or partial evaporation of a surface film of less than one monolayer equivalent.

The Gas Evolution Test showed an increase in the water vapor pressure. The release rate was non-linear and showed a temperature dependence. Moisture release rate at temperature equilibrium of ~80°C was ~2 Torr/hr.

Water released during the Gas Evolution Test and HVD step 1 suggests that water was desorbed from components that were exposed to hot argon at near-atmospheric pressure. The most likely source of the water release is from the desorption of water from the fiberglass components of particulate filters, when they are heated by the hot argon. When the system is operated under vacuum conditions, the argon loses its heat very rapidly to the walls of the tubing after leaving the heated retort, and, as a result, the filters are not heated significantly. At higher pressures the argon heats the tubing and the filters to higher temperatures, causing the water release. Other tests, including a second dry-run, that were performed entirely under vacuum conditions, were not complicated by this effect. Total water removed during HVD was ~36 mg.

Calculated water removal during the latter phase of CVD, during HVD, and during cooldown, is similar to that observed for the first whole element test (Element 1990 – Run 1). Element 1990 was an essentially intact element with no observable breaches. Values observed for the second drying test (Element 3128W – Run 2) were somewhat larger (up to a factor of 10). Element 3128W also had no visible cladding breaches, but had a grayish-white surface coating. In contrast with the present test, where no water was added, both earlier tests were conducted with wet fuel elements, using the same experimental protocol. The similarity in these values, therefore, indicates that most of the free water is removed from the fuel element and/or system retort by the end of the condenser pumpdown phase of CVD. The somewhat larger values for remaining free water observed in Element 3128W are likely due to holdup of water by the observed surface coating, some of which was not released until higher temperatures.

Only qualitative hydrogen data were obtained from the MS detector due to variability in the inlet pressure when the system was at atmospheric pressure. Data that were collected during the portions of the test conducted at vacuum proved to be within the background level of the MS quadrupole detector. As a result, meaningful concentration data were not obtained from the MS for the release of hydrogen or fission gases. No significant krypton or xenon releases were noted in the MS data. The weak krypton and xenon signals that were observed were well correlated with nitrogen, indicating slight in-leakage of cell air.

Hydrogen data were obtained from the GC during CVD and HVD when argon was flowing through the system. During CVD, hydrogen was released at a constant rate of ~ 0.002 Torr·l with a total release of ~ 2.0 Torr·l. In the HVD test, hydrogen was observed starting at about 180°C and continued to evolve at increasing rates with temperature to a maximum level of ~ 0.009 Torr·l. At 410°C , the level of hydrogen began to decrease with time. Hydrogen dissolved on metal surfaces is concluded to be the most plausible source. The data do not indicate that any metal hydrides were decomposed. Total hydrogen release during HVD step 2 and Water Removal Verification was ~ 2.2 Torr·l. Total hydrogen removed during HVD was several orders of magnitude lower than observed in the “wet” drying run of Element 1990 (Run 1) and Element 3128W (Run 2). Hydrogen levels during the subsequent Water Removal Verification step were comparable to Element 3128W, suggesting similar levels of remaining hydrogen either from oxidation or desorption from metal surfaces in the system retort and associated components.

6.0 References

CRC Press. 1997. *Handbook of Chemistry and Physics*, 78th edition. New York.

Ritter, G. A., S. C. Marschman, P. J. MacFarlan, and D. A. King. 1998. *Whole Element Furnace Testing System*. PNNL-11807, Pacific Northwest National Laboratory, Richland, Washington.

Westinghouse Hanford Company (WHC). 1995. *Hanford Spent Nuclear Fuel Project Integrated Process Strategy for K Basins Spent Nuclear Fuel*. WHC-SD-SNF-SP-005, Rev. 0, Richland, Washington.

7.0 Supporting Documents and Related Reports

Abrefah, J. and S. C. Marschman. 1997. *Test Plan for Whole Element Furnace Runs 1, 2, and 3*. SNFCT97:053:R00, Pacific Northwest National Laboratory, Richland, Washington.

Gerry, W. M. 1997a. *Calibration of Mass Flow Controllers*. SNF-TP-012, Rev. 0, Pacific Northwest National Laboratory, Richland, Washington.

Gerry, W. M. 1997b. *Calibration of Balzer Quadstar Mass Spectrometer*. SNF-TP-014, Rev. 0, Pacific Northwest National Laboratory, Richland, Washington.

Gerry, W. M. 1997c. *Calibration of MTI Gas Chromatograph Model M200*. SNF-TP-013, Rev. 0, Pacific Northwest National Laboratory, Richland, Washington.

Serles, J. A. 1997. *Postirradiation Testing Laboratory Work Plan for Furnace Testing*. 327-RS-97-018, Rev. 0, Pacific Northwest National Laboratory, Richland, Washington.

Reports are written separately for the whole element drying test series as follows:

System Design Description for the Whole Element Furnace Testing System

Spent Fuel Drying System Test Results (First Dry-Run)

Spent Fuel Drying System Test Results (Second Dry-Run)

Spent Fuel Drying System Test Results (Third Dry-Run)

Drying Results of K-Basin Fuel Element 1990 (Run 1)

Drying Results of K-Basin Fuel Element 3128W (Run 2)

Drying Results of K-Basin Fuel Element 0309M (Run 3)

Drying Results of K-Basin Fuel Element 5744U (Run 4)

Drying Results of K-Basin Fuel Element 6603M (Run 5)

Drying Results of K-Basin Fuel Element 1164M (Run 6)

Drying Results of K-Basin Fuel Element 2660M (Run 7)

Drying Results of K-Basin Fuel Element 6513U (Run 8)