

KN

SEP 04 1997

ENGINEERING DATA TRANSMITTAL

Page 1 of 1
1. EDT 156943

Station 34

2. To: (Receiving Organization) Distribution	3. From: (Originating Organization) FDNW TWRS Engineering Services	4. Related EDT No.: N/A
5. Proj./Prog./Dept./Div.: Interim Stabilization	6. Design Authority/ Design Agent/Cog. Engr.: O. D. Nelson	7. Purchase Order No.: N/A
8. Originator Remarks: For approval and release. ^{KN}		9. Equip./Component No.: POR-004 Skid B POR-005 Skid C POR-006 Skid D
11. Receiver Remarks: 11A. Design Baseline Document? <input type="checkbox"/> Yes <input checked="" type="checkbox"/> No		10. System/Bldg./Facility: N/A
		12. Major Assm. Dwg. No.: N/A
		13. Permit/Permit Application No.: N/A
		14. Required Response Date: 6-10-97

15. DATA TRANSMITTED					(F)	(G)	(H)	(I)
(A) Item No.	(B) Document/Drawing No.	(C) Sheet No.	(D) Rev. No.	(E) Title or Description of Data Transmitted	Approval Designator	Reason for Transmittal	Originator Disposition	Receiver Disposition
1	HNF-SD-WM-RPT-302		0	Portable Exhausters POR-004-Skid B, POR-005-Skid C, POR-006-Skid D Storage Plan	Q	1	1	

16. KEY

Approval Designator (F)	Reason for Transmittal (G)	Disposition (H) & (I)
E, S, Q, D or N/A (see WHC-CM-3-5, Sec.12.7)	1. Approved 2. Release 3. Information 4. Review 5. Post-Review 6. Dist. (Receipt Acknow. Required)	1. Approved 2. Approved w/comment 3. Disapproved w/comment 4. Reviewed no/comment 5. Reviewed w/comment 6. Receipt acknowledged

17. SIGNATURE/DISTRIBUTION
(See Approval Designator for required signatures)

(G) Reason	(H) Disp.	(J) Name	(K) Signature	(L) Date	(M) MSIN	(G) Reason	(H) Disp.	(J) Name	(K) Signature	(L) Date	(M) MSIN
1	1	Des.Cog.Eng. O.D. Nelson	<i>[Signature]</i>	7/14/97	52-24			Central Files	A3-88		
1	6	Proj. Mgr. E.M. Veith	<i>[Signature]</i>	7/14/97	R1 8/8/97						
1	1	Progr. Mgr. D.W. Crass	<i>[Signature]</i>	7/14/97	H3 6/8/97						
4		SST Stab. D.J. Saueressig	<i>[Signature]</i>	68-05							
1	1	QA T.J. Volkman	<i>[Signature]</i>	7/14/97	34-07						
1	1	TWRS HVAC System Cog. Eng. T.D. Kaiser	<i>[Signature]</i>	7/16/97	T4-07						

18. Signature of EDT Originator <i>[Signature]</i> Date: 7/16/97	19. Authorized Representative for Receiving Organization <i>[Signature]</i> Date:	20. Design Authority/Cognizant Manager <i>[Signature]</i> Date:	21. DOE APPROVAL (if required) Ctrl. No. <input type="checkbox"/> Approved <input type="checkbox"/> Approved w/comments <input type="checkbox"/> Disapproved w/comments
--	---	---	--

PORTABLE EXHAUSTERS POR-004-SKID B, POR-005-SKID C, POR-006 SKID D STORAGE PLAN

Craig M. Keller
Fluor-Daniel Northwest, Richland, WA 99352
U.S. Department of Energy Contract DE-AC06-96RL13200

EDT/ECN: 156943 ^{KN} UC: 2030
Org Code: 04E00 Charge Code: C13697
B&R Code: EW3120072 Total Pages: 41 ^{KN}

Key Words: Portable Exhauster, Saltwell Pumping, Waste Tank Ventilation, Flammable Gas Mitigation

Abstract: This document provides a storage plan for portable exhausters POR-004 SKID B, POR-005 SKID C, AND POR-006 SKID D. The exhausters will be stored until they are needed by the TWRS Saltwell Pumping Program. The storage plan provides criteria for portable exhauster storage, periodic inspections during storage, and retrieval from storage.

TRADEMARK DISCLAIMER. Reference herein to any specific commercial product, process, or service by trade name, trademark, manufacturer, or otherwise, does not necessarily constitute or imply its endorsement, recommendation, or favoring by the United States Government or any agency thereof or its contractors or subcontractors.

Printed in the United States of America. To obtain copies of this document, contact: Document Control Services, P.O. Box 950, Mailstop H6-08, Richland WA 99352, Phone (509) 372-2420; Fax (509) 376-4989.

Karen A. Roland 9/4/97
Release Approval Date

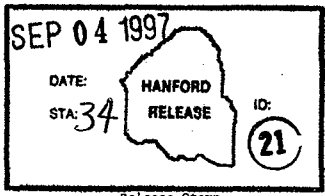

Approved for Public Release

HNF-SD-WM-RPT-302, Rev 0

PORTABLE EXHAUSTERS

POR-004-SKID B

POR-005-SKID C

POR-006-SKID D

STORAGE PLAN

Table of Contents

1.0 OBJECTIVE 1

2.0 Preparation for Storage 1

 2.1 Exhauster Arrangement 1

 2.2 Skid 1

 2.2.1 Support Jacks 1

 2.2.2 Paint 1

 2.3 Filter Train 2

 2.3.1 Filters 2

 2.3.1.1 Pre-filter 2

 2.3.1.2 HEPA filter 2

 2.3.2 Access doors 2

 2.3.3 Filter Train Isolation Valves 2

 2.3.4 Filter Train Inlet Isolation 2

 2.4 Seal Pot System 3

 2.4.1 Seal Pot 3

 2.4.2 Drain line Valves 3

 2.5 Glycol Heater System 3

 2.6 Exhaust Stack 3

 2.6.1 Exhaust Stack 3

 2.6.2 Tubing 4

 2.7 Exhaust Fan 4

 2.8 Electrical Components 4

 2.8.1 Message View Cabinet 4

 2.8.2 Action Pak's 4

 2.8.3 Intrinsic Cabinet 4

 2.8.4 Yokogawaw Pressure Transmitters 4

 2.8.5 Control Cabinet 4

 2.8.6 Drexelbrook Liquid Level Transmitters and Probe 5

 2.8.7 Wilkerson Indicators 5

 2.9 Schedule and Checklist 5

3.0 Storage Inspections and Maintenance 5

 3.1 Support Jacks 5

 3.2 Paint 5

 3.3 Insulation 5

 3.4 Filter Train Isolation 6

HNF-SD-WM-RPT-302, Rev 0

3.5	Stack Isolation	6
3.6	Fan Shaft Rotation	6
3.7	Schedule and Checklist	6
4.0	Retrival from Storage	6
4.1	Exhauster Arrangement	6
4.2	Skid	6
4.2.1	Support Jacks	6
4.2.2	Paint	7
4.3	Filter Train	7
4.3.1	Filters	7
4.3.1.1	Pre-filter	7
4.3.1.2	HEPA filter	7
4.3.2	Access doors	7
4.3.3	Filter Train Isolation Valves	7
4.3.4	Filter Train Inlet Isolation	8
4.3.5	Filter Train Insulation	8
4.3.6	Filter Train Interior	8
4.4	Seal Pot System	8
4.4.1	Seal Pot	8
4.4.2	Drain line Valves	8
4.5	Glycol Heater System	9
4.6	Exhaust Stack	9
4.6.1	Exhaust Stack	9
4.6.2	Tubing	9
4.7	Exhaust Fan	9
4.8	Electrical Components	9
4.8.1	Message View Cabinet	9
4.8.2	Action Pak's	9
4.8.3	Intrinsic Cabinet	10
4.8.4	Yokogawaw EA. Pressure Transmitters	10
4.8.5	Control Cabinet	10
4.8.6	Drexelbrook Liquid Level Transmitters and Probe:	10
2.7	Schedule and Checklist	10
5.0	ORGANIZATIONAL RESPONSIBILITIES	10
6.0	FUNDING	11
7.0	SCHEDULE	11

HNF-SD-WM-RPT-302, Rev 0

FIGURE - 1 12

FIGURE - 2 13

FIGURE - 3 14

FIGURE - 4 15

Appendix - A A - 1

Appendix - B B - 1

Appendix - C C - 1

Appendix - D D - 1

HNF-SD-WM-RPT-302, Rev 0

1.0 OBJECTIVE

The objective of this document is to provide criteria to place portable exhausters POR-004-Skid B, POR-005-Skid C and POR-006-Skid D into storage, inspections required during storage and retrieval from storage.

2.0 Preparation for Storage

2.1 Exhauster Arrangement

The portable exhausters will be placed in a fenced area that is normally locked located at 2727-W in 200W area. The portable exhauster shall be placed such that the control cabinet side of the exhauster shall be placed facing North. This is to minimize temperatures inside of the various cabinets on the portable exhauster. Additionally, the exhauster shall be placed on a surface (such as gravel) that promotes the drainage of rainwater from around the portable exhauster. A minimum clearance of 3" between the bottom of the exhauster and grade shall be maintained.

The portable exhauster shall be sloped such that rainwater will not accumulate on the upper surfaces of the filter train and various electrical cabinets. This shall be accomplished by adjusting the leveling jacks such that a slope is achieved towards the control cabinet direction.

2.2 Skid

2.2.1 Support Jacks

In order to prevent the formation of corrosion on the slide mechanism, all exposed sliding surfaces shall be coated with Sunaplex 992-EP grease or a grease that meets the requirements of MIL-G-10924.

2.2.2 Paint

Perform a inspection of the painted surfaces of the exhauster skid for the formation of corrosion. If corrosion is detected, the corrosion shall be removed and the surface shall be primed with one coat of fast dry industrial rust inhibitive primer and with two coats of fast dry industrial enamel. Finish color shall be grey. Apply paint per manufactures instructions.

HNF-SD-WM-RPT-302, Rev 0

2.3 Filter Train

2.3.1 Filters

2.3.1.1 Pre-filter

Remove the pre-filter and place into storage identified for the portable exhauster. Place the pre-filter into a plastic storage bag and store in the Saltwell Pumping Program Conex storage.

2.3.1.2 HEPA filter

Remove the first and second stage HEPA filters. Cover both faces of the HEPA filter with 18 gauge 304L stainless steel covers. These covers will be manufactured by DynCorp 200 West site fabrication services. Secure both covers to the HEPA filter with adhesive tape and place the HEPA filters into the Saltwell Pumping Program Conex storage. For each of the HEPA filters, label one of the stainless steel covers with "H-14-100867 Rev 0, Part #24" using ½" high letters and black spray paint. No special requirement is required of the paint.

2.3.2 Access doors

The access doors for the prefilter and both HEPA filters shall be closed and latched. The latching mechanism shall be secured such the gasketed on these doors is compressed.

2.3.3 Filter Train Isolation Valves

Both the 12" and 6" filter train isolation valves shall be in the fully closed position.

2.3.4 Filter Train Inlet Isolation

A isolation plate and associated gasket shall be placed on the 12" inlet flange. This isolation plate, gasket and required bolting are specified on Figure - 1. Fabrication shall be by DynCorp 200 West site fabrication services.

HNF-SD-WM-RPT-302, Rev 0

2.4 Seal Pot System

2.4.1 Seal Pot

Tilt the exhauster in the direction of the seal pot drain and drain the seal pot by opening Seal Pot drain valve VTP-V-160. Drain the contents into a suitable container. Connect pressurized air to the seal pot fill valve, VTP-V-158 and allow 10 psig compressed air to flow through the seal pot at a flow rate of 5 cubic feet per minute. Allow this to happen for a minimum of 5 minutes. Inspect each of the drains in the filter train and fan housing to ensure moisture was not blown into the filter train. If so, remove moisture.

2.4.2 Drain line Valves

Seal Pot overflow valve VTP-V-161 and Seal Pot drain valve VTP-V-160 shall be in the closed position and have blind flanges, gasketing and bolting installed as identified on H-14-100867 sheet 12. Seal Pot fill valve VTP-V-159 shall be in the closed position and have a threaded plug installed per H-14-100867 sheet 12. Fan drain line valve VTP-V-158 shall be in the closed position.

2.5 Glycol Heater System

and Drain the contents of the glycol expansion tank (VTP-TK-001) into a suitable container by opening pump isolation valves (VTP-V-201/202) and VTP-TK-001 drain valve (VTP-V-204). Remove glycol circulation pump VTP-P-001 connect a flanged fitting to the pump flange connection leading to VTP-V-202. Place a catch basin under valves VTP-V-201 and VTP-V-204. Connect pressurized air to the flanged fitting and allow 10 psig compressed air to flow through the glycol system. Allow this to happen for a minimum of 5 minutes. Reinstall glycol circulation pump VTP-V-001. Leave valves VTP-V-201/202 open and close VTP-V-204.

2.6 Exhaust Stack

2.6.1 Exhaust Stack

Remove the exhaust stack and place onto the support structure as specified in Figure - 2. A isolation plate, associated gasket and bolting shall be placed on the lower stack top flange. This isolation plate, gasket

HNF-SD-WM-RPT-302, Rev 0

and required bolting are specified on Figure - 3. Fabrication shall be by DynCorp 200 West site fabrication services.

2.6.2 Tubing

Cap the two 1/4" stainless steel tubes that go to the stack flow instrument (Verabar) with 1/4" Swagelock caps (SS-400-C).

2.7 Exhaust Fan

Lubricate the fan motor and shaft bearings with Shell Alavania EP2 Lf grease prior to placing the exhauster into storage.

2.8 Electrical Components

2.8.1 Message View Cabinet

Ensure that the Message View cabinet, front panel has been properly closed.

2.8.2 Action Pak's

Because of vibrations while moving the system to a storage location, it would be advisable to remove the action pak's and store the system with these Limit Alarms removed. These are easily removed and installed 11 pin cubes. Store these in the Saltwell Pumping Program Conex storage

2.8.3 Intrinsic Cabinet

Ensure that the intrinsic cabinet front panel has been properly closed and secured.

2.8.4 Yokogawaw Pressure Transmitters

The DA manifolds valves to the internal plenum should remain open to allow some small pressure changes in the transmitters diaphragm housing.

2.8.5 Control Cabinet

Ensure that the weather covers on the control cabinet have been properly installed and the control panel front panel has been properly secured.

HNF-SD-WM-RPT-302, Rev 0

2.8.6 Drexelbrook Liquid Level Transmitters and Probe

Ensure the liquid level transmitters weather covers O-Rings are in good condition and cover is completely closed.

2.8.7 Wilkerson Indicators

There are no Special storage requirements for the Wilkerson indicators. These should remain in place during storage.

2.9 Schedule and Checklist

The schedule to place the portable exhausters into storage is presented in Appendix - 1. A checklist that ensures all of the actions to place the portable exhausters into storage is presented in Appendix - B.

3.0 Storage Inspections and Maintenance

3.1 Support Jacks

Inspect the support jacks for signs of corrosion or dirt on the sliding mechanism. Re-lubricate outer surface of inner tube assembly with a light coating of Sunaplex 992-EP (or grease meeting MIL-G-10924).

3.2 Paint

Perform a inspection of the painted surfaces on the portable exhausters for corrosion. If corrosion is detected, the corrosion shall be removed and the surface shall be primed with one coat of fast dry industrial rust inhibitive primer and with two coats of fast dry industrial enamel. Finish color shall be grey. Apply paint per manufactures instructions

3.3 Insulation

Inspect the filter train and drain line insulation for signs of deterioration and cracking in the protective coating. Replace any deterioration insulation with Armstrong Armaflex II sheet insulation. Insulation shall be secured with Armstrong 520 adhesive. Apply per manufactures instructions. Protective coating shall be Armstrong standard white color. Apply per manufactures instructions.

HNF-SD-WM-RPT-302, Rev 0

3.4 Filter Train Isolation

Insure that the isolation plates and gasketing are in place on the filter train inlet and fan outlet.

3.5 Stack Isolation

Insure that the isolation plates for the exhaust stack are in place.

3.6 Fan Shaft Rotation

On a monthly basis, rotate the fan shaft 10 rotations by hand to ensure that the shaft bearings do not develop flat spots. Note the initial position of the fan shaft using the shaft keyway as a reference. After the 10 shaft rotations, ensure that the keyway is +/- 90 degrees from the initial position.

3.7 Schedule and Checklist

The schedule for storage inspections and maintenance of the portable exhausters is presented in Appendix - 1. A checklist that ensures all of the actions for storage inspections and maintenance is presented in Appendix - C.

4.0 Retrieval from Storage

4.1 Exhauster Arrangement

The portable exhauster shall be taken out of the sloped condition and placed in the level position using a level indicator. A general cleanup of the outer surfaces of the exhauster to remove dust and any other surface contamination shall be performed. Cleaning process shall be dictated by the Cognizant Engineer

4.2 Skid

4.2.1 Support Jacks

Extend each jack assembly to the full stroke extension, wipe the jack inner tube assemble with a cloth to eliminate any sand or abrasive particles from the surface. Re-lubricate outer surface of inner tube assembly with light coating of Sunplex 992-EP (or grease meeting MIL-G-10924).

HNFDSDWMRPT302, Rev 0

4.2.2 Paint

Perform an inspection of the painted surfaces on the portable exhausters for corrosion. If corrosion is detected, the corrosion shall be removed and the surface shall be primed with one coat of fast dry industrial rust inhibitive primer and with two coats of fast dry industrial enamel. Finish color shall be grey. Apply paint per manufacturer's instructions.

4.3 Filter Train

4.3.1 Filters

4.3.1.1 Pre-filter

Remove the pre-filter from storage and inspect for damage. If damage is discovered, replace with part number 30 of H-14-100867 sheet 1. Reinstall pre-filter into the portable exhauster.

4.3.1.2 HEPA filter

Remove the HEPA filters from storage and inspect for damage. If damage is discovered, replace with part number 24 of H-14-100867 sheet 1. Remove the stainless steel face covers that were attached when the HEPA filters were placed into storage. Remove the used fluid seal gel from the HEPA filter and reinstall fresh Flanders Filters fluid seal gel (Flanders Filters Part number, E0600299 & E0600300). Reinstall HEPA filters in the portable exhauster.

4.3.2 Access doors

The access doors for the prefilter and both HEPA filters shall be closed and latched after the filters have been installed. The latching mechanism shall be secured such that the gasketed on these doors is evenly compressed.

4.3.3 Filter Train Isolation Valves

Open and close both the 12" and 6" filter train isolation valves to ensure the valves still operate normally.

HNF-SD-WM-RPT-302, Rev 0

4.3.4 Filter Train Inlet Isolation

Remove the isolation plate and associated gasket from the 12" inlet flange.

4.3.5 Filter Train Insulation

Inspect the filter train and drain line insulation for signs of deterioration and cracking in the protective coating. Replace any deterioration insulation with Armstrong Armaflex II sheet insulation. Insulation shall be secured with Armstrong 520 adhesive. Apply per manufactures instructions. Protective coating shall be Armstrong standard white color. Apply per manufactures instructions.

4.3.6 Filter Train Interior

Inspect the interior of the filter train for intrusion by the elements or other contaminants. If detected, clean per Cognizant Engineers instructions.

4.4 Seal Pot System

4.4.1 Seal Pot

Pour a minimum of 1 gallon of water into each of the following drains while the sealpot drain valve (VTP-V-160) is in the open position and draining into a suitable container:

- a) Pre-filter
- b) First stage test section
- c) First stage HEPA filter
- d) second stage test section
- e) Second stage HEPA filter
- f) Fan

Completely drain the seal pot into a suitable container.

4.4.2 Drain line Valves

After the flushing of the seal pot, the Seal Pot overflow valve VTP-V-161 and Seal Pot drain valve VTP-V-160 shall be in the closed position and have blind flanges, gasketing and bolting installed as identified on H-14-100867 sheet 12. Seal Pot fill valve VTP-V-159 shall be in the closed

HNF-SD-WM-RPT-302, Rev 0

position and have a threaded plug installed per H-14-100867 sheet 12. Fan drain line valve VTP-V-158 shall be in the closed position.

4.5 Glycol Heater System

Ensure that the glycol expansion tank/system is at least 3/4 full with a 50-50 mixture of propylene glycol. Verify that the glycol expansion tank vent is not clogged to allow the expansion tank to remain at atmospheric pressure.

4.6 Exhaust Stack

4.6.1 Exhaust Stack

Remove the isolation plates and associated gasket placed on the exhaust stack.

4.6.2 Tubing

UnCap the two 1/4" stainless steel tubes that go to the stack flow instrument (Verabar).

4.7 Exhaust Fan

Lubricate the fan motor and shaft bearings with Shell Alavania EP2 LF grease. Rotate the fan shaft a minimum of 20 revolutions by hand.

4.8 Electrical Components

4.8.1 Message View Cabinet

Ensure that the Message View cabinet, front panel has been properly closed by verifying the lack of excessive dust. If excessive dust is discovered, clean cabinet per Cognizant engineers instructions.

4.8.2 Action Pak's

Reinstall action PAK modules per H-14-100869 sheet 1.

HNFS-D-WM-RPT-302, Rev 0

4.8.3 Intrinsic Cabinet

Ensure that the Stahl cabinet has been properly closed by verifying the lack of excessive dust. If excessive dust is discovered, clean cabinet per Cognizant engineers instructions.

4.8.4 Yokogawaw Pressure Transmitters

Verify that the DA manifold valves to the filter plenum are open.

4.8.5 Control Cabinet

Ensure that the Control cabinet has been properly closed by verifying the lack of excessive dust. If excessive dust is discovered, cleancabinett per Cognizant engineers instructions.

4.8.6 Drexelbrook Liquid Level Transmitters and Probe:

Ensure liquid level transmitters weather covers O-Rings are in good condition and cover is completely closed.

4.9 Schedule and Checklist

The schedule to take the portable exhausters out of storage is presented in Appendix - 1. A checklist that ensures all of the actions to take the portable exhausters out of storage is presented in Appendix - D.

5.0 ORGANIZATIONAL RESPONSIBILITIES

TWRS Safety Programs will have the responsibility of preparing portable exhausters (POR -004-Skid B, POR-005-Skid C and POR-006-Skid D) for storage as defined in this document (with the exceptions of sections 2.1 and 2.2.1). TWRS Saltwell Pumping Program will have the responsibility of transporting the portable exhausters and miscellaneous equipment (prefilter, HEPA filters, etc) from 277W to the Saltwell Pumping Program storage location (laydown area and storage conex). Once the exhausters have been placed into storage at 2727-W, TWRS Saltwell Pumping Program will become the equipment owners.

HNF-SD-WM-RPT-302, Rev 0

6.0 FUNDING

TWRS Safety Programs will provide the funding to prepare the portable exhausters (POR -004-Skid B, POR-005-Skid C and POR-006-Skid D) for storage as defined in section 5.0 of this document. Saltwell Pumping Program will provide all additional costs to place the portable exhausters into storage.

7.0 SCHEDULE

The schedule for placement, storage duration and required inspections is presented in Appendix - 1 of this document.

GASKET MATERIAL, 1/4" THK, NEOPRENE
ASTM D2000, 40-45 DURO

SHEET, 11 GA X ϕ 19"

HEAVY HEX SCREW, 7/8"-9UNC-2A X
2 3/4" L, W/HEAVY HEX NUT,
7/8"-9UNC-2B AND WASHER, 7/8"
12 PL

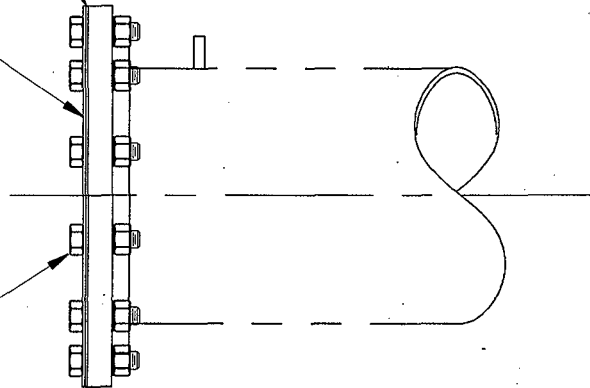

12" INLET ISOLATION PLATE

FIGURE 1

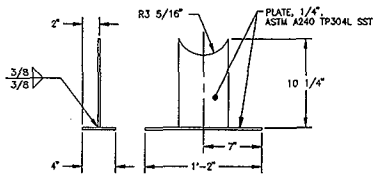

(A) DETAIL

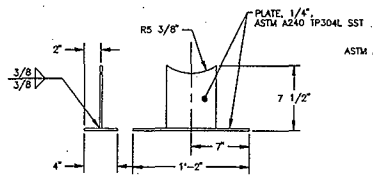

(B) DETAIL

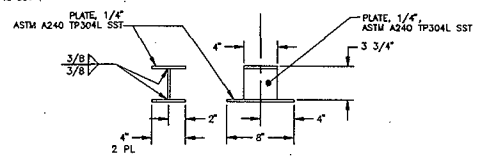

(C) DETAIL

13

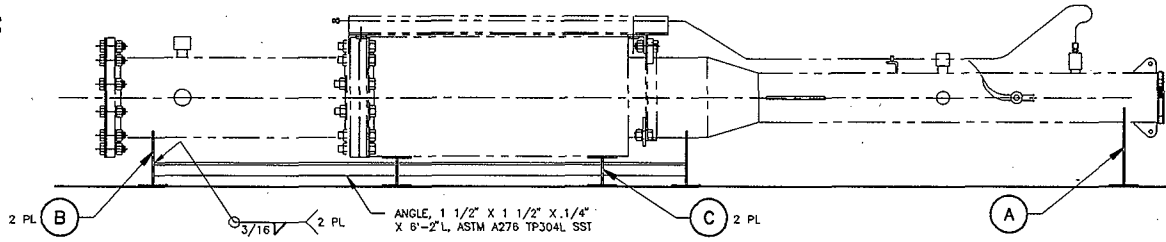

STACK SUPPORT STRUCTURE

FIGURE 2

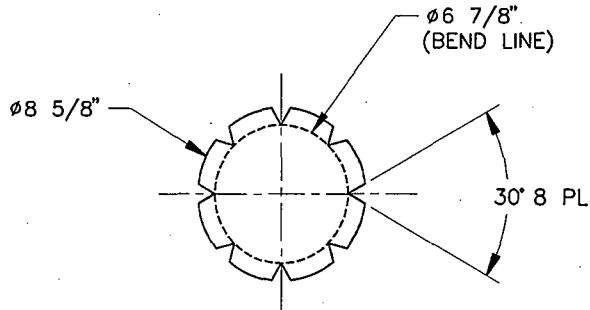

DETAIL

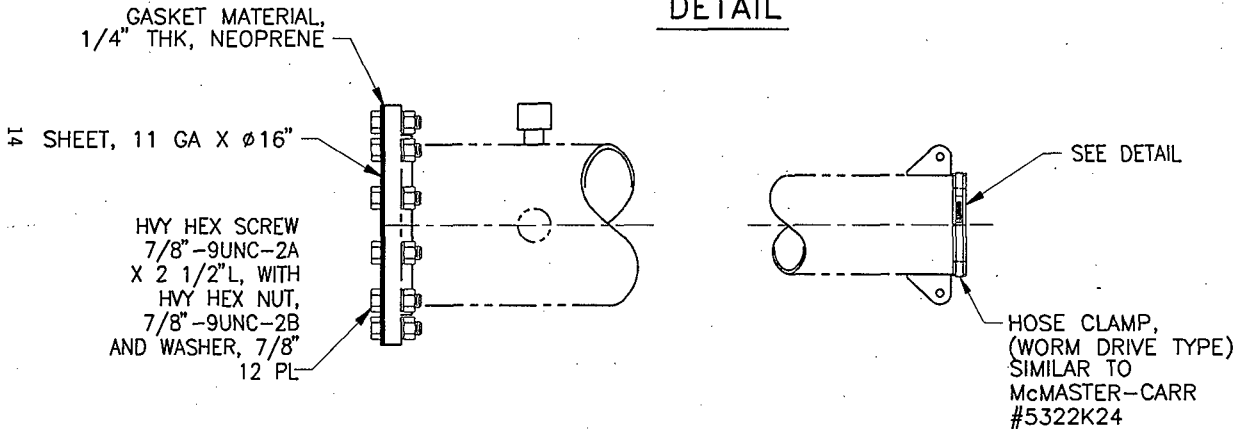

STACK ISOLATION PLATE & TOP COVER

FIGURE 3

HEAVY HEX SCREW,
3/4"-10UNC-2A X 2 1/4" L,
W/HEAVY HEX NUT,
3/4"-10UNC-2B, AND
WASHER, 3/4"
8 PL

SHEET, 11 GA X Ø11"

GASKET MATERIAL,
1/4" THK, NEOPRENE
40-45 DURO,
ASTM D2000

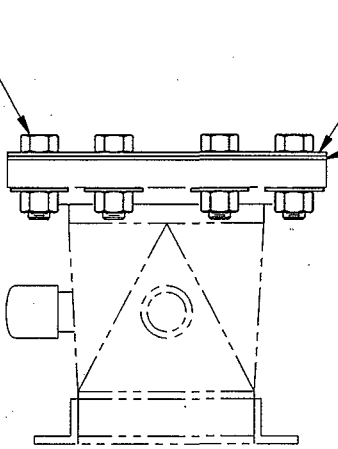







SQUARE TO ROUND ISOLATION PLATE

FIGURE 4

APPENDIX - A

Schedule

ID	Task Name	Duration	3, 1997			Qtr 4, 1997			Qtr 1, 1998			Qtr 2, 1998			Qtr 3, 1998			Qtr 4, 1998			Qtr 1, 1999			Qtr 2, 1999		
			Aug	Sep	Oct	Nov	Dec	Jan	Feb	Mar	Apr	May	Jun	Jul	Aug	Sep	Oct	Nov	Dec	Jan	Feb	Mar	Apr	May	Jun	
1	Storage of Exhausters	5d																								
2	Remove filters	1d																								
3	Filter Train Isolation	1d																								
4	Seal Pot	1d																								
5	Glycol heater	1d																								
6	Stack	1d																								
7	Exhaust fan	1d																								
8	Electrical	3d																								
9	Transport to storage	1d																								
10																										
11	Storage duration	265d	[Shaded bar from Sep 1997 to Sep 1998]																							
12																										
13	Maintenance of Exh's	3d																								
14	Support jacks	1d																								
15	Paint	3d																								
16	Insulation	3d																								
17	Filter train Isolation	1d																								
18	Stack Isolation	1d																								
19																										
20	Retrival from storage	7d																								
21																										
22	Support jacks	1d																								
23	Paint	3d																								

Task  Summary  Rolled Up Progress 
 Progress  Rolled Up Task 
 Milestone  Rolled Up Milestone 

Project: Saltwell Programs Portable Ex
Date: 6/18/97

A - 2

NHF-SO-MM-RPT-302, Rev 0

ID	Task Name	Duration	3, 1997			Qtr 4, 1997			Qtr 1, 1998			Qtr 2, 1998			Qtr 3, 1998			Qtr 4, 1998			Qtr 1, 1999			Qtr 2, 1999		
			Aug	Sep	Oct	Nov	Dec	Jan	Feb	Mar	Apr	May	Jun	Jul	Aug	Sep	Oct	Nov	Dec	Jan	Feb	Mar	Apr	May	Jun	
24	Reinstall filters	1d																								
25	Filter train unisolation	2d																								
26	Insulation	3d																								
27	Seal pot	1d																								
28	Glycol heater	1d																								
29	Exhaust stack	3d																								
30	Exhaust fan	1d																								
31	Electrical	3d																								

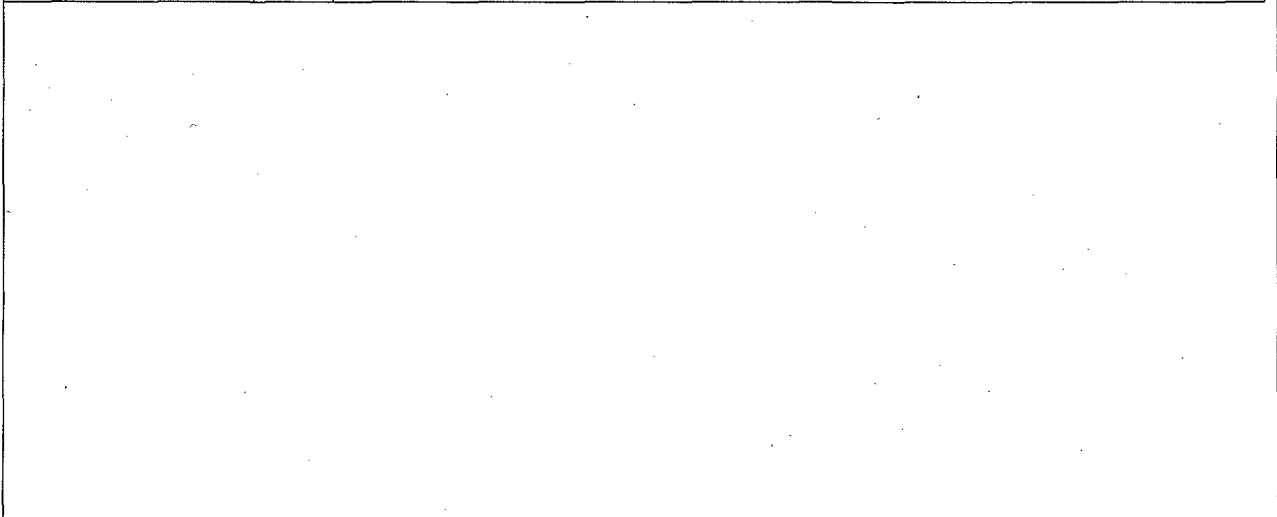





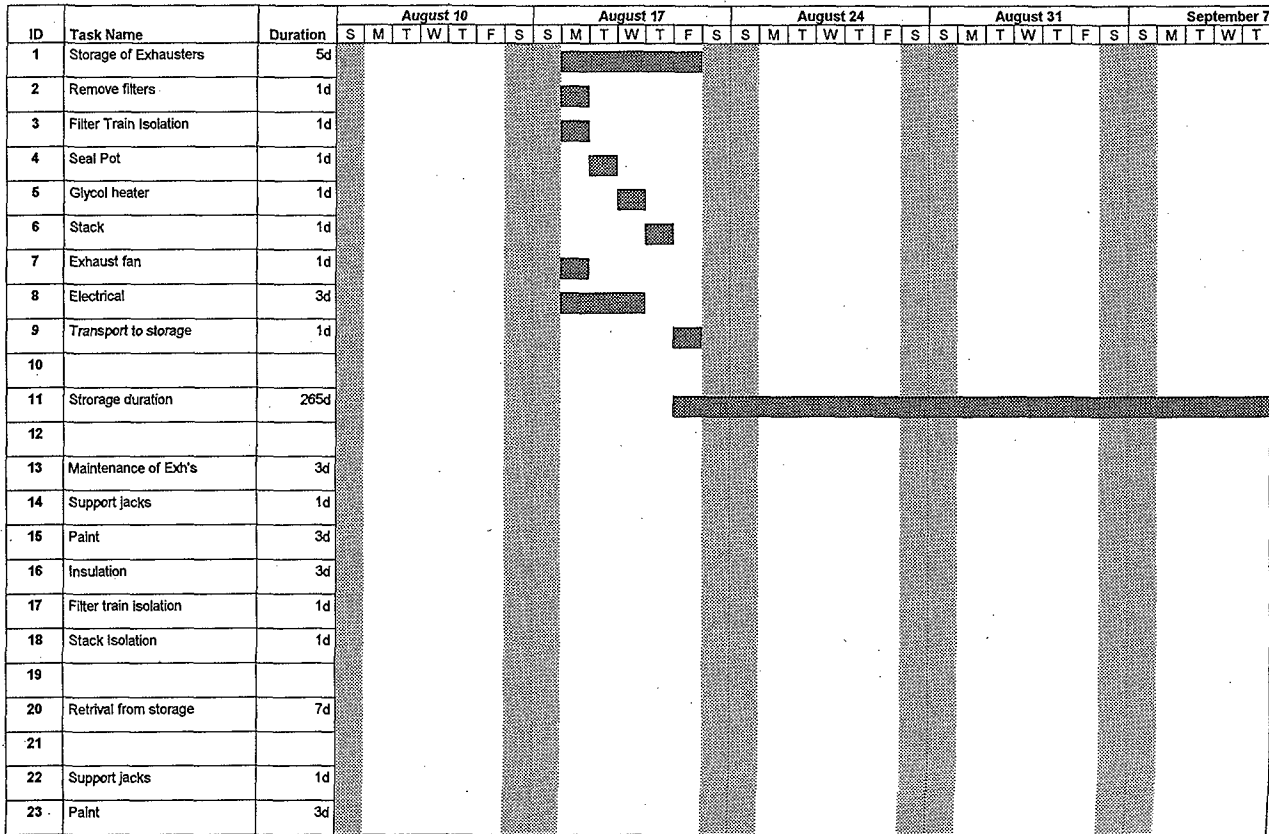

Project: Saltwell Programs Portable Ex Date: 6/18/97	Task		Summary		Rolled Up Progress	
	Progress		Rolled Up Task			
	Milestone		Rolled Up Milestone			

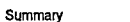
A - 3







HNF-SD-WM-RPT-302, Rev 0

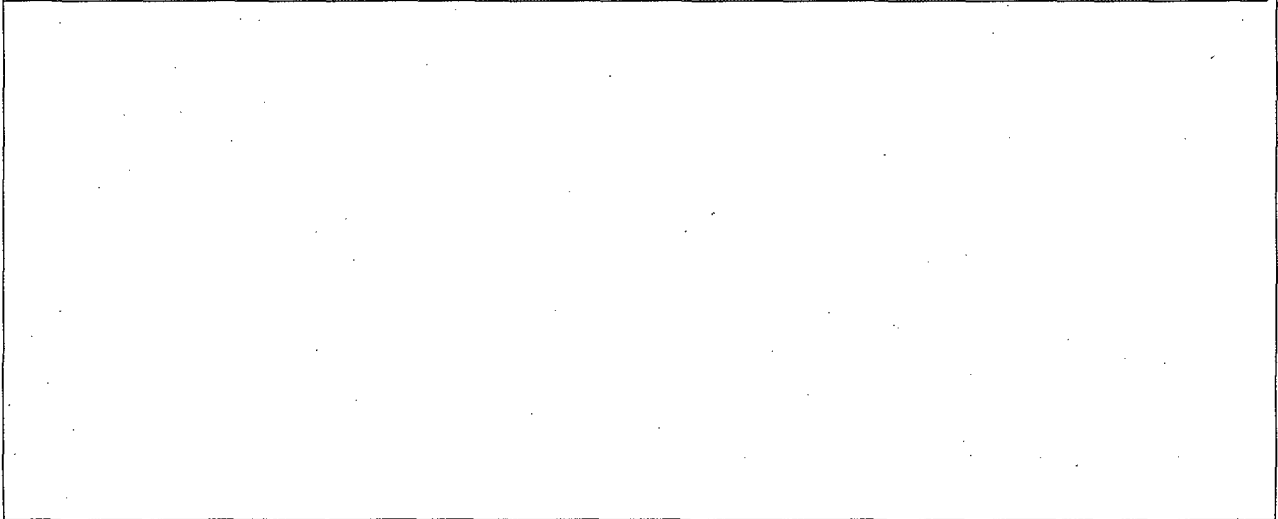

Project: Saltwell Programs Portable Ex Date: 6/18/97	Task 	Summary 		Rolled Up Progress 
	Progress 	Rolled Up Task 		
	Milestone 	Rolled Up Milestone 		

ID	Task Name	Duration	August 10							August 17							August 24							August 31							September 7															
			S	M	T	W	T	F	S	S	M	T	W	T	F	S	S	M	T	W	T	F	S	S	M	T	W	T	F	S	S	M	T	W	T											
24	Reinstall filters	1d																																												
25	Filter train unisolation	2d																																												
26	Insulation	3d																																												
27	Seal pot	1d																																												
28	Glycol heater	1d																																												
29	Exhaust stack	3d																																												
30	Exhaust fan	1d																																												
31	Electrical	3d																																												



Task  Summary  Rolled Up Progress 
 Progress  Rolled Up Task 
 Milestone  Rolled Up Milestone 

Project: Saltwell Programs Portable Ex
Date: 6/18/97

A-5

ID	Task Name	Duration	February 8					February 15					February 22					March 1					March 8							
			S	M	T	W	T	F	S	S	M	T	W	T	F	S	S	M	T	W	T	F	S	S	M	T	W	T		
1	Storage of Exhausters	5d																												
2	Remove filters	1d																												
3	Filter Train Isolation	1d																												
4	Seal Pot	1d																												
5	Glycol heater	1d																												
6	Stack	1d																												
7	Exhaust fan	1d																												
8	Electrical	3d																												
9	Transport to storage	1d																												
10																														
11	Storage duration	265d																												
12																														
13	Maintenance of Exh's	3d																												
14	Support jacks	1d																												
16	Paint	3d																												
16	Insulation	3d																												
17	Filter train isolation	1d																												
18	Stack isolation	1d																												
19																														
20	Retrival from storage	7d																												
21																														
22	Support jacks	1d																												
23	Paint	3d																												

Project: Saltwell Programs Portable Ex
Date: 6/18/97

Task

Progress

Milestone



Summary

Rolled Up Task

Rolled Up Milestone







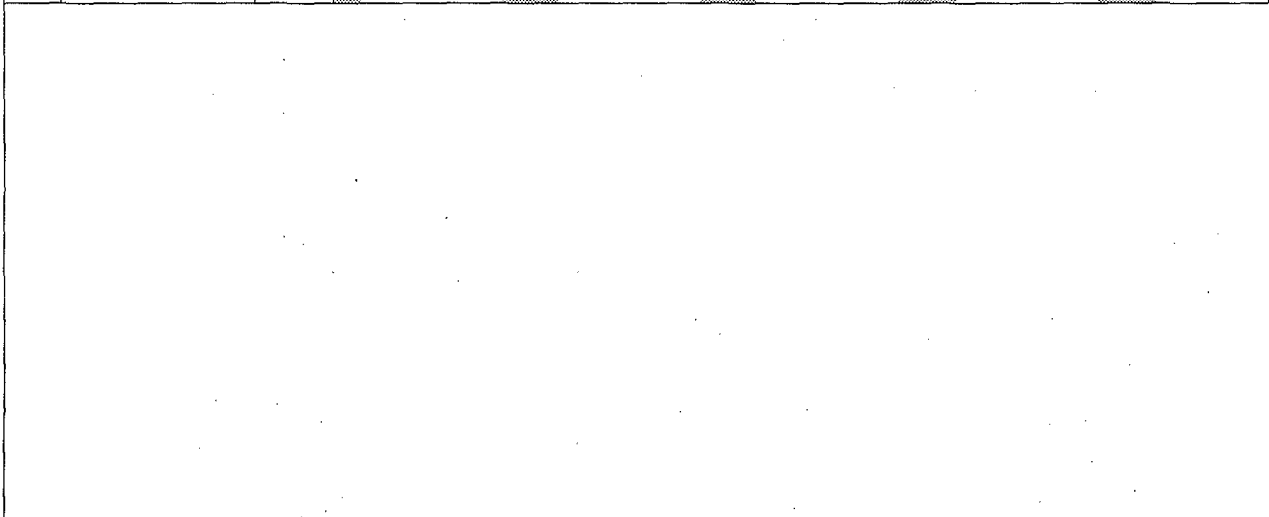

Rolled Up Progress



ID	Task Name	Duration	February 8							February 15							February 22							March 1							March 8						
			S	M	T	W	T	F	S	S	M	T	W	T	F	S	S	M	T	W	T	F	S	S	M	T	W	T	F	S	S	M	T	W	T		
24	Reinstall filters	1d																																			
25	Filter train unisolation	2d																																			
26	Insulation	3d																																			
27	Seal pot	1d																																			
28	Glycol heater	1d																																			
29	Exhaust stack	3d																																			
30	Exhaust fan	1d																																			
31	Electrical	3d																																			





Project: Saltwell Programs Portable Ex Date: 6/18/97	Task		Summary		Rolled Up Progress	
	Progress		Rolled Up Task			
	Milestone		Rolled Up Milestone			

A-7

ID	Task Name	Duration	August 9							August 16							August 23							August 30							September 6								
			S	M	T	W	T	F	S	S	M	T	W	T	F	S	S	M	T	W	T	F	S	S	M	T	W	T	F	S	S	M	T	W	T				
1	Storage of Exhausters	5d																																					
2	Remove filters	1d																																					
3	Filter Train Isolation	1d																																					
4	Seal Pot	1d																																					
5	Glycol heater	1d																																					
6	Stack	1d																																					
7	Exhaust fan	1d																																					
8	Electrical	3d																																					
9	Transport to storage	1d																																					
10																																							
11	Storage duration	265d																																					
12																																							
13	Maintenance of Exh's	3d																																					
14	Support jacks	1d																																					
16	Paint	3d																																					
16	Insulation	3d																																					
17	Filter train isolation	1d																																					
18	Stack Isolation	1d																																					
19																																							
20	Retrival from storage	7d																																					
21																																							
22	Support jacks	1d																																					
23	Paint	3d																																					

Project: Saltwell Programs Portable Ex
Date: 6/18/97

Task 
Progress 
Milestone 

Summary 
Rolled Up Task 
Rolled Up Milestone 

Rolled Up Progress 

ID	Task Name	Duration	August 9							August 16							August 23							August 30							September 6						
			S	M	T	W	T	F	S	S	M	T	W	T	F	S	S	M	T	W	T	F	S	S	M	T	W	T	F	S	S	M	T	W	T		
24	Reinstall filters	1d																																			
25	Filter train unisolation	2d																																			
26	Insulation	3d																																			
27	Seal pot	1d																																			
28	Glycol heater	1d																																			
29	Exhaust stack	3d																																			
30	Exhaust fan	1d																																			
31	Electrical	3d																																			

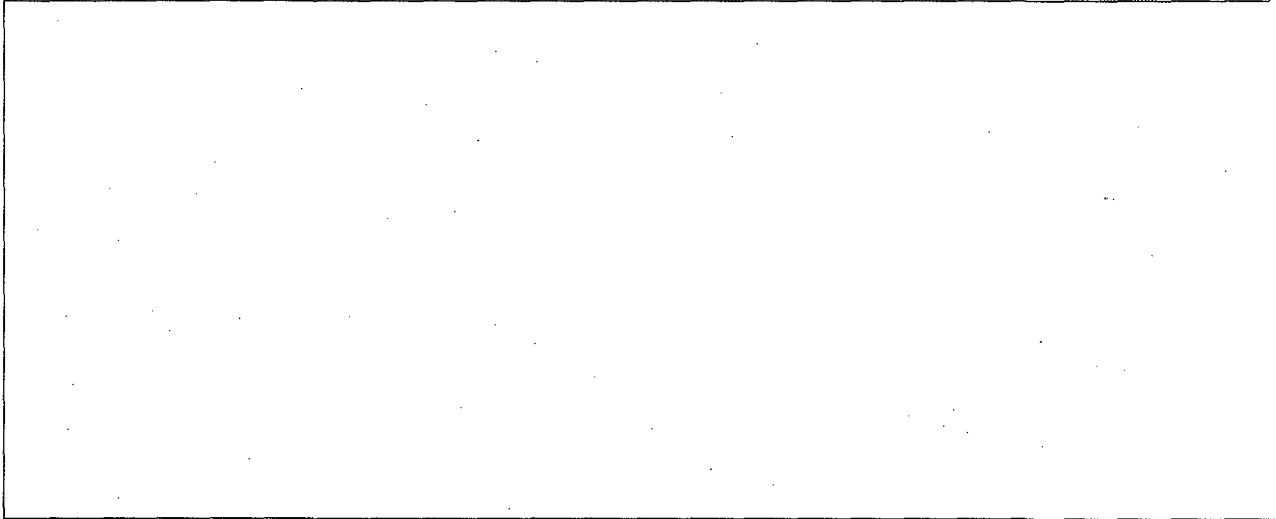

Project: Saltwell Programs Portable Ex Date: 6/18/97	Task		Summary		Rolled Up Progress	
	Progress		Rolled Up Task			
	Milestone		Rolled Up Milestone			

A - 9

HNF-SD-WM-RPT-302, Rev 0

HNF-SD-WM-RPT-302, Rev 0

Appendix - B

Storage Check List

HNF-SD-WM-RPT-302, Rev 0

POR-004-Skid B Storage Checklist			
Document Section	Description	Cog. Eng/Date	QC/Date
2.1	Exhauster Arrangement		
2.2.1	Support Jacks		
2.2.2	Paint		
2.3.1.1	Pre-filter		
2.3.1.2	HEPA filters		
2.3.2	Access doors		
2.3.3	Filter Train Isolation Valves		
2.3.4	Filter Train Inlet Isolation		
2.4.1	Seal Pot		
2.4.2	Drain Line Valves		
2.5	Glycol Heater System		
2.6.1	Exhaust Stack		
2.6.2	Tubing		
2.7	Exhaust Fan		
2.8.1	Message View Cabinet		
2.8.2	Action Pak's		
2.8.3	Intrinsic Cabinet		
2.8.4	Yokogawa Pressure Transmitters		
2.8.5	Control Cabinet		
2.8.6	Drexelbrook Liquid Level Transmitter/Probes		
2.8.7	Wilkerson Indicators		

HNF-SD-WM-RPT-302, Rev 0

POR-005-Skid C Storage Checklist			
Document Section	Description	Cog. Eng/Date	QC/Date
2.1	Exhauster Arrangement		
2.2.1	Support Jacks		
2.2.2	Paint		
2.3.1.1	Pre-filter		
2.3.1.2	HEPA filters		
2.3.2	Access doors		
2.3.3	Filter Train Isolation Valves		
2.3.4	Filter Train Inlet Isolation		
2.4.1	Seal Pot		
2.4.2	Drain Line Valves		
2.5	Glycol Heater System		
2.6.1	Exhaust Stack		
2.6.2	Tubing		
2.7	Exhaust Fan		
2.8.1	Message View Cabinet		
2.8.2	Action Pak's		
2.8.3	Intrinsic Cabinet		
2.8.4	Yokogawa Pressure Transmitters		
2.8.5	Control Cabinet		
2.8.6	Drexelbrook Liquid Level Transmitter/Probes		
2.8.7	Wilkerson Indicators		

HNF-SD-WM-RPT-302, Rev 0

POR-006-Skid D Storage Checklist			
Document Section	Description	Cog. Eng/Date	QC/Date
2.1	Exhauster Arrangement		
2.2.1	Support Jacks		
2.2.2	Paint		
2.3.1.1	Pre-filter		
2.3.1.2	HEPA filters		
2.3.2	Access doors		
2.3.3	Filter Train Isolation Valves		
2.3.4	Filter Train Inlet Isolation		
2.4.1	Seal Pot		
2.4.2	Drain Line Valves		
2.5	Glycol Heater System		
2.6.1	Exhaust Stack		
2.6.2	Tubing		
2.7	Exhaust Fan		
2.8.1	Message View Cabinet		
2.8.2	Action Pak's		
2.8.3	Intrinsic Cabinet		
2.8.4	Yokogawa Pressure Transmitters		
2.8.5	Control Cabinet		
2.8.6	Drexelbrook Liquid Level Transmitter/Probes		
2.8.7	Wilkerson Indicators		

HNF-SD-WM-RPT-302, Rev 0

Appendix - C

Storage Inspection and Maintenance Check List

HNF-SD-WM-RPT-302, Rev 0

POR-004-Skid C Storage Inspection and Maintenance Checklist			
Document Section	Description	Cog Eng/Date	QC/Date
3.1	Support Jacks		
3.2	Paint		
3.3	Insulation		
3.4	Filter Train Isolation		
3.5	Stack Isolation		
3.6	Fan Shaft Rotation		
3.6	Fan Shaft Rotation		
3.6	Fan Shaft Rotation		
3.6	Fan Shaft Rotation		
3.6	Fan Shaft Rotation		
3.6	Fan Shaft Rotation		
3.6	Fan Shaft Rotation		
3.6	Fan Shaft Rotation		
3.6	Fan Shaft Rotation		
3.6	Fan Shaft Rotation		
3.6	Fan Shaft Rotation		
3.6	Fan Shaft Rotation		
3.6	Fan Shaft Rotation		
3.6	Fan Shaft Rotation		
3.6	Fan Shaft Rotation		

HNF-SD-WM-RPT-302, Rev 0

POR-005-Skid D Storage Inspection and Maintenance Checklist			
Document Section	Description	Cog Eng/Date	QC/Date
3.1	Support Jacks		
3.2	Paint		
3.3	Insulation		
3.4	Filter Train Isolation		
3.5	Stack Isolation		
3.6	Fan Shaft Rotation		
3.6	Fan Shaft Rotation		
3.6	Fan Shaft Rotation		
3.6	Fan Shaft Rotation		
3.6	Fan Shaft Rotation		
3.6	Fan Shaft Rotation		
3.6	Fan Shaft Rotation		
3.6	Fan Shaft Rotation		
3.6	Fan Shaft Rotation		
3.6	Fan Shaft Rotation		
3.6	Fan Shaft Rotation		
3.6	Fan Shaft Rotation		
3.6	Fan Shaft Rotation		
3.6	Fan Shaft Rotation		
3.6	Fan Shaft Rotation		

HNF-SD-WM-RPT-302, Rev 0

POR-006-Skid E Storage Inspection and Maintenance Checklist			
Document Section	Description	Cog Eng/Date	QC/Date
3.1	Support Jacks		
3.2	Paint		
3.3	Insulation		
3.4	Filter Train Isolation		
3.5	Stack Isolation		
3.6	Fan Shaft Rotation		
3.6	Fan Shaft Rotation		
3.6	Fan Shaft Rotation		
3.6	Fan Shaft Rotation		
3.6	Fan Shaft Rotation		
3.6	Fan Shaft Rotation		
3.6	Fan Shaft Rotation		
3.6	Fan Shaft Rotation		
3.6	Fan Shaft Rotation		
3.6	Fan Shaft Rotation		
3.6	Fan Shaft Rotation		
3.6	Fan Shaft Rotation		
3.6	Fan Shaft Rotation		
3.6	Fan Shaft Rotation		
3.6	Fan Shaft Rotation		

HNF-SD-WM-RPT-302, Rev 0

Appendix - D

Retrival From Storage Check List

HNF-SD-WM-RPT-302, Rev 0

POR-004-Skid B Retrieval From Storage Checklist			
Document Section	Description	Cog. Eng/Date	QC/Date
4.1	Exhauster Arrangement		
4.2.1	Support Jacks		
4.2.2	Paint		
4.3.1.1	Pre-filter		
4.3.1.2	HEPA filters		
4.3.2	Access doors		
4.3.3	Filter Train Isolation Valves		
4.3.4	Filter Train Inlet Isolation		
4.3.5	Filter Train Insulation		
4.3.6	Filter Train Interior		
4.4.1	Seal Pot		
4.4.2	Drain Line Valves		
4.5	Glycol Heater System		
4.6.1	Exhaust Stack		
4.6.2	Tubing		
4.7	Exhaust Fan		
4.8.1	Message View Cabinet		
4.8.2	Action Pak's		
4.8.3	Intrinsic Cabinet		
4.8.4	Yokogawa Pressure Transmitters		
4.8.5	Control Cabinet		
4.8.6	Drexelbrook Liquid Level Transmitter/Probes		
4.8.7	Wilkerson Indicators		

HNF-SD-WM-RPT-302, Rev 0

POR-005-Skid C Retrieval From Storage Checklist			
Document Section	Description	Cog. Eng/Date	QC/Date
4.1	Exhauster Arrangement		
4.2.1	Support Jacks		
4.2.2	Paint		
4.3.1.1	Pre-filter		
4.3.1.2	HEPA filters		
4.3.2	Access doors		
4.3.3	Filter Train Isolation Valves		
4.3.4	Filter Train Inlet Isolation		
4.3.5	Filter Train Insulation		
4.3.6	Filter Train Interior		
4.4.1	Seal Pot		
4.4.2	Drain Line Valves		
4.5	Glycol Heater System		
4.6.1	Exhaust Stack		
4.6.2	Tubing		
4.7	Exhaust Fan		
4.8.1	Message View Cabinet		
4.8.2	Action Pak's		
4.8.3	Intrinsic Cabinet		
4.8.4	Yokogawa Pressure Transmitters		
4.8.5	Control Cabinet		
4.8.6	Drexelbrook Liquid Level Transmitter/Probes		
4.8.7	Wilkerson Indicators		

HNF-SD-WM-RPT-302, Rev 0

POR-006-Skid D Retrieval From Storage Checklist			
Document Section	Description	Cog. Eng/Date	QC/Date
4.1	Exhauster Arrangement		
4.2.1	Support Jacks		
4.2.2	Paint		
4.3.1.1	Pre-filter		
4.3.1.2	HEPA filters		
4.3.2	Access doors		
4.3.3	Filter Train Isolation Valves		
4.3.4	Filter Train Inlet Isolation		
4.3.5	Filter Train Insulation		
4.3.6	Filter Train Interior		
4.4.1	Seal Pot		
4.4.2	Drain Line Valves		
4.5	Glycol Heater System		
4.6.1	Exhaust Stack		
4.6.2	Tubing		
4.7	Exhaust Fan		
4.8.1	Message View Cabinet		
4.8.2	Action Pak's		
4.8.3	Intrinsic Cabinet		
4.8.4	Yokogawa Pressure Transmitters		
4.8.5	Control Cabinet		
4.8.6	Drexelbrook Liquid Level Transmitter/Probes		
4.8.7	Wilkerson Indicators		