



SE0100008

Technical Report

TR-00-18

On the risk of liquefaction of buffer and backfill

Roland Pusch
Geodevelopment AB

October 2000

Svensk Kärnbränslehantering AB

Swedish Nuclear Fuel
and Waste Management Co
Box 5864
102 40 Stockholm
Tel 08-459 84 00
Fax 08-661 57 19

32 / 07



**PLEASE BE AWARE THAT
ALL OF THE MISSING PAGES IN THIS DOCUMENT
WERE ORIGINALLY BLANK**

On the risk of liquefaction of buffer and backfill

Roland Pusch
Geodevelopment AB

October 2000

Keywords: liquefaction, buffer, backfill, bentonite, earthquake.

This report concerns a study which was conducted for SKB. The conclusions and viewpoints presented in the report are those of the author and do not necessarily coincide with those of the client.

Abstract

The necessary prerequisites for liquefaction of buffers and backfills in a KBS-3 repository exist but the stress conditions and intended densities practically eliminate the risk of liquefaction for single earthquakes with magnitudes up to $M=8$ and normal duration. For buffers rich in expandable minerals it would be possible to reduce the density at water saturation to $1,700\text{--}1,800\text{ kg/m}^3$ or even less without any significant risk of liquefaction, while the density at saturation of backfills with 10–15% expandable clay should not be reduced to less than about $1,900\text{ kg/m}^3$. Since the proposed densities of both buffers and backfills will significantly exceed these minimum values it is concluded that there is no risk of liquefaction of the engineered soil barriers in a KBS-3 repository even for very significant earthquakes.

Summary

A necessary criterion for liquefaction is that the soil must undergo compression and the major question is hence whether seismically induced shear stresses will yield denser layering and the concomitant increase in porewater pressure that produces fluid conditions. For MX-80 buffer with a density exceeding 1,700–1,800 kg/m³ at saturation this criterion does not apply because the expansion potential is too high and the load on the buffer clay exerted by the overlying backfill too low to produce compression.

The less clayey tunnel backfill is only exposed to a load corresponding to its own weight and the vertical effective stress in the uppermost part is therefore very low. If the density and clay content are low, compression may take place by earthquake-induced shearing but field experiments in the underground laboratories at Stripa and Äspö have shown that backfills consisting of mixtures of MX-80 bentonite and crushed rock can be compacted to a bulk density, about 2,000 kg/m³, that is sufficiently high to avoid liquefaction. By selecting a content of expandable clay of 30% the swelling potential of the backfill makes it resist seismically induced compression even at lower bulk densities.

It is concluded that there is no risk of liquefaction of the engineered soil barriers in a KBS-3 repository even for very significant earthquakes.

Sammanfattning

Ett nödvändigt villkor för att flyttillstånd ("liquefaction") skall uppstå är att jordmaterialet komprimeras och den viktigaste frågan är alltså om seismiskt orsakade spänningar ger tätare partikellagring med den samhöriga por-trycksökning som åstadkommer flytning. För vattenmättad buffert av MX-80 med högre densitet än 1,700–1,800 kg/m³ uppfylls inte detta villkor eftersom svällningsförmågan är för stor och belastningen av överliggande tunnelåterfyllning för liten för att åstadkomma kompression.

Den lerfattigare tunnelåterfyllningen bär en last som endast svarar mot egentyngheden och vertikalktrycket är därför mycket lågt i dess övre del. Om densiteten och lerhalten är mycket låga kan kompression ske men fältförsök i underjordslaboratorierna i Stripa och Äspö har visat att återfyllning bestående av blandningar av MX-80 bentonit och krossat berg får en densitet, ca 2,000 kg/m³, som är tillräckligt hög för att undvika seismiskt orsakat flyttillstånd. Genom att välja en halt av svällande lermaterial av minst 30% blir svällningspotentialen hos återfyllningen tillräcklig för att motstå seismiskt orsakad kompression också vid lägre densitet.

Slutsatsen av studien är att flyttillstånd inte kan uppkomma i de geotekniska barriärerna buffert och återfyllning i KBS-3-förvar även vid mycket stora jordbävningar.

List of figures

Figure 2-1. Shear-induced deformation of silt or sand. Upper: Shear stress versus strain at horizontal shearing of shear box. Lower: Vertical strain as a function of horizontal shearing.	16
Figure 2-2. Change in packing of particles by liquefaction [3].	17
Figure 3-1. Schematic section through sand dikes cutting through clay. The dikes are formed by liquefaction of the lower sand layer from which fluidized sand moves up at weak points of the overlaying clay layer.	19
Figure 3-2. Curves showing grain sizes and gradations that are susceptible to liquefaction [3].	20
Figure 3-3. Six basic layering types assuming equally sized spherical grains.	21
Figure 3-4. Schematic picture of buffer microstructure at saturation. I) Dense, expanded bentonite grain (“granule”). II) Clay gel formed in the voids between the grains [6].	23
Figure 3-5. Schematic grain arrangement of clayey backfill. G=Ballast grains. D=Clay aggregate [6].	24
Figure 3-6. Field load conditions means initial vertical effective stress and horizontal shear stress due to existing earth pressure conditions and superimposed seismically induced cyclic shear stress [3].	25
Figure 3-7. Relationship between earthquake magnitude (M) and horizontal distance from earthquake epicenter to the farthest liquefaction event [3].	26
Figure 3-8. Increase in porewater pressure with increased number of stress cycles at the JNC experiment. The experiment with the stress ratio 0.241 was terminated early but is expected to have yielded high porewater pressure after some tens of hundreds of stress cycles.	29
Figure 3-9. Relationship between number of cycles of liquefaction and stress ratio as derived from the JNC experiments.	30

Contents

1	Introduction	9
2	Processes causing liquefaction	11
2.1	Shear strength of soils	11
2.1.1	The effective stress concept	11
2.1.2	Mechanisms involved in shear failure	11
2.1.3	Strength reduction of clayey soils	13
2.1.4	Quick clay	13
2.2	Conditions for liquefaction	14
3	Tectonically induced liquefaction	15
3.1	Introduction	15
3.2	Liquefaction susceptibility	16
3.2.1	General	16
3.2.2	Density	17
3.3	Earthquake magnitudes related to liquefaction	21
3.3.1	Seismic processes yielding liquefaction	21
3.3.2	General experience	21
3.3.3	Rock structure considerations	23
3.3.4	Earthquake-related porewater pressure	23
3.3.5	Earthquake effects on slopes	24
3.4	Experimental	24
4	Discussion and conclusions	27
4.1	Relevance	27
4.2	Seismic energy considerations	27
4.3	Susceptibility to liquefaction of buffers and backfills under repository conditions	27
4.4	General conclusions	29
	References	31

1 Introduction

Earthquakes are known to have caused very severe instability of soil and rock in the form of slope failure and fracturing in many parts of the world. A special phenomenon termed liquefaction, which is the transformation of soil material from a solid state into liquid form as a consequence of increased porewater pressure, is the cause of certain slope failures in clay/silt and the reason for the formation of sand dikes and mud volcanoes in clayey soil overlying sand and silt [1,2,3]. Liquefaction in a repository would cause a risk for tilting and sinking of the canisters in the deposition holes and transformation of tunnel backfill into a fluid with no ability to support the roof. The present document deals with the implications and consequences of liquefaction induced by seismic events.

2 Processes causing liquefaction

2.1 Shear strength of soils

2.1.1 The effective stress concept

The effective stress concept is basic to any shear strength issue concerning soils:

Where:

$$\tau = c' + (\sigma_{tot} - u) \tan \phi \quad (1)$$

τ = shear strength

c' = cohesion (intercept of the t axis in diagram with $(\sigma_{tot} - u) = s'$ on the other axis)

σ_{tot} = total pressure

u = porewater pressure

ϕ = angle of internal friction

$(\sigma_{tot} - u) = \sigma' =$ effective pressure normal to the failure plane

The general meaning of Equation (1) is that an increase in effective pressure, e.g. by increasing the total pressure under drained conditions, increases the shear strength approximately in proportion to the pressure increase. When “consolidation” has been reached under any effective pressure, a subsequent reduction in pressure means that water is absorbed by the released, expanding soil by which the particle interaction gets weaker and the shear strength is accordingly reduced. The parameter ϕ is just a measure of how the shear strength is related to the effective pressure.

2.1.2 Mechanisms involved in shear failure

The detailed shearing process gives a somewhat different meaning of the cohesion and internal friction terms. Under water saturated conditions, cohesion represents the undrained shear strength when the shearing is sufficiently quick to prevent porewater flow within or into or out of the soil. Frictional soils, i.e. silt, sand, gravel and coarser materials, do not have any cohesion under water saturated conditions; their shear strength is solely dependent on the effective pressure except when shearing takes place at a very high rate.

In very fine-grained soils that are rich in clay particles (minus 2 mm), the particle interaction on the molecular scale provides the bulk shear strength through covalent and hydrogen bonds as well as ion-pairing. If a mechanically undisturbed sample extracted from clay that has consolidated under constant overburden is sheared slowly under drained conditions, the maximum shear stress is found to be according to Equation (1), ϕ being (10–30°). The shear strength is higher than for the undisturbed sample if σ' is higher than the in situ overburden pressure and lower if it is lower than this pressure. Quick shearing gives a (undrained) shear strength equal to $\sigma_{tot}/2$, ϕ being 0°.

For silts, sands and gravel, the part of the shear strength caused by internal friction, which increases with increasing effective pressure, is caused by true mechanical interaction of contacting particles, and by the dilatant work required to produce relative movement of contacting particles. The latter comprises macrodilatancy caused when particles are forced to pass over each other, and microdilatancy caused when surface roughnesses interact. An increase in shear strain hence increases the shear resistance up to a maximum value and then reduces it to a constant, lower value. This density corresponds to the state of critical layering (Figure 2-1). In contrast to clays, the hydraulic conductivity is high enough to cause dissipation of the porewater pressure parallel to the shearing such that σ_{tot} is usually equal to σ' .

If the porewater pressure increases while the total pressure remains constant, like under artesian conditions, the second term of Equation (1) decreases and thereby the shear strength. This also applies to the case when the porewater pressure remains constant and the effective pressure drops due to collapse of the particle network. Coarser soils usually have a sufficiently high hydraulic conductivity to undergo drainage during shearing by which the porewater pressure may not reach a critical level. However, there are examples of coarse soils that turned liquid by seismic events as discussed later in this document.

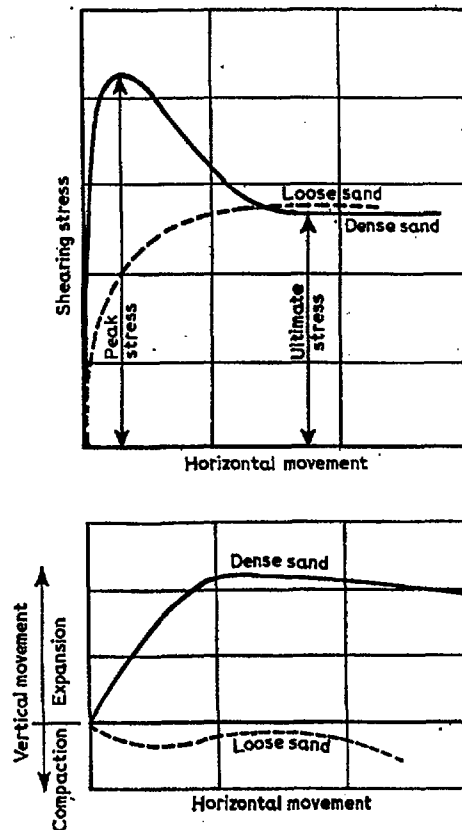

Figure 2-1. Shear-induced deformation of silt or sand. Upper: Shear stress versus strain at horizontal shearing of shear box. Lower: Vertical strain as a function of horizontal shearing.

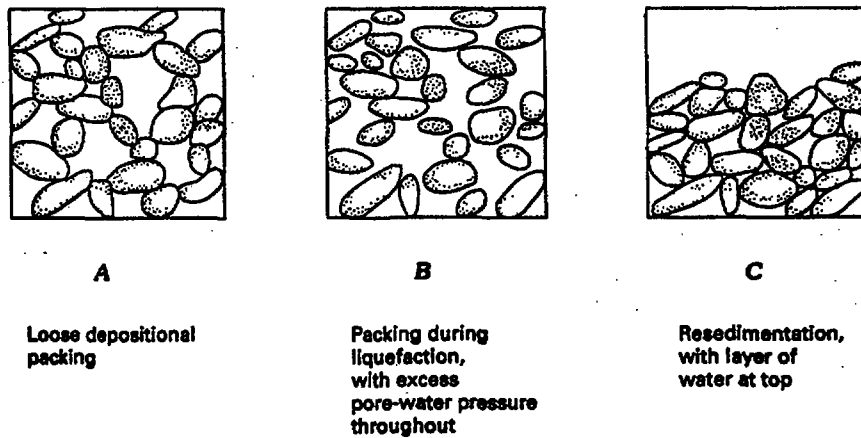

Figure 2-2. Change in packing of particles by liquefaction (3).

Liquefaction caused by reduction of the shear strength requires that the energy input and shear strain is sufficiently large to reduce the effective stress (grain pressure), which requires structural breakdown. In turn, this implies that the particles are in loose layering, cf. Figure 2-2. The figure shows that dense soils expand until failure occurs, after which a slight decrease in volume occurs. Loosely layered soil, on the other hand, compacts when sheared and its ultimate resistance approximates that of the failed dense soil. Silt, sand and gravel in loose state is liable to “shake down” under the action of earth tremors.

2.1.3 Strength reduction of clayey soils

Definition of sensitivity

The loss in undrained shear strength on strong disturbance (remolding) is expressed by the sensitivity S_r , which is the ratio of the undisturbed undrained strength and the strength after remolding. S_r can be as low as unity and as high as 200, which means that the clay turns fluid.

2.1.4 Quick clay

For normally consolidated lacustrine and marine illitic clays with a density ranging between 1,500 and 1,700 kg/m³, S_r is 10–20, while it may be higher than 100 if the clays are marine and have been percolated with freshwater or water with dispersion agents, like humic substances. Such soils are termed quick clays. Despite their thixotropic nature smectite clays with these densities do not exhibit higher sensitivities than about 10, while softer smectites are more sensitive and may turn liquid. Denser clays have a very low sensitivity and cannot be brought into liquid condition. For high-sensitivity clays the Atterberg liquid limit, determined by conventional soil mechanical laboratory methods, is equal to or higher than the water content. Liquefaction of quick clays can be caused by earthquakes since they have an aggregated, unstable microstructural constitution [3].

Fluidized soil by liquefaction

Liquefaction of gravel, sand, silt and clayey silt by seismic effects can reduce the shear strength to a small fraction of what it is under static load. Since, under constant total stress conditions, the shear strength is proportional to the effective stress the reduction in strength by seismic oscillation depends on the generated porewater pressure. If it becomes equal to the total pressure the loss in shear strength is complete, corresponding to a sensitivity number similar to that of quick clays.

2.2 Conditions for liquefaction

A number of conditions must be fulfilled for producing liquefaction:

1. Strong mechanical agitation for breakage of particle bonds.
2. Collapse of the particle network when shearing beyond the peak resistance.
3. Low hydraulic conductivity for maintaining natural or induced high porewater pressure.
4. Complete water saturation.

The key requirement for liquefaction is loose layering. It is a prerequisite for the collapse of the particle network, which produces the reduction in effective pressure that causes shear failure.

3 Tectonically induced liquefaction

3.1 Introduction

Seismically induced liquefaction of saturated frictional soils has been studied extensively [3]. Figure 3-1 illustrates a common result of liquefaction of shallow ground, i.e. upward flow of fluidized soil through a non-liquefiable layer, forming clastic dikes. Examples of such seismic effects are numerous as illustrated by investigations in many parts of the world of ancient ("paleoliquefaction") and recent formation of liquefaction-induced features [3]. The ones of particular interest are those witnessed by observers and photographs, amongst which are the following earthquakes: South Carolina (Charleston) in 1886, India in 1899, Alaska in 1964, California (Imperial Valley) in 1979, and Japan in 1989 [3].

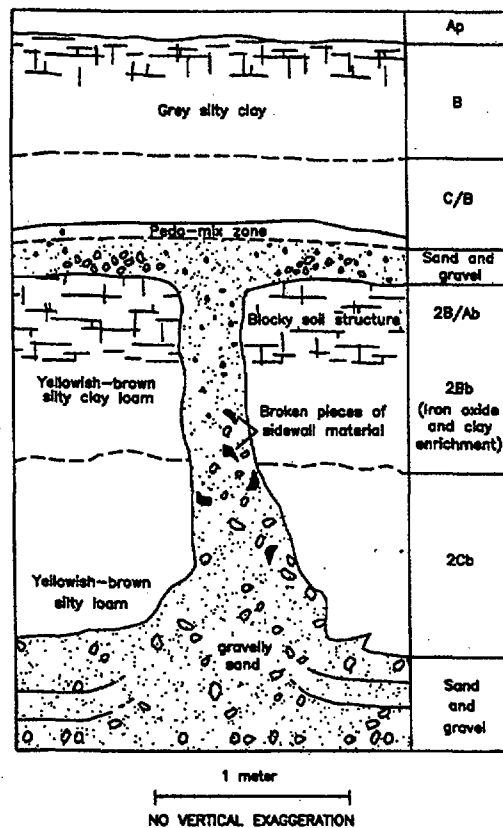

Figure 3-1. Schematic section through sand dikes cutting through clay. The dikes are formed by liquefaction of the lower sand layer from which fluidized sand moves up at weak points of the overlying clay layer.

3.2 Liquefaction susceptibility

3.2.1 General

Liquefaction susceptibility implies that the soil particles are in loose layering and that cohesive interparticle forces are very weak, which applies to soft silt, sand or gravel. In practice, soft silt and clayey silt are the soil types that are believed to undergo liquefaction most easily. Figure 3-2 shows the corresponding grain size span, the density of the soils being of particular importance.

The criteria for susceptibility specified in Section 2.2 imply that cohesionless, loosely layered, rather fine-grained soils like silt and clayey silt or sand are most sensitive to earthquakes and this is also documented by the Alaskan and other huge liquefaction events. However, the broken curve in Figure 3-2, which represents the coarsest material found to have undergone liquefaction shows that also sand/gravel soils can liquefy if the oscillations are critically large ($M=7.3$ for this particular event). A content of clay-sized (minus 2 mm) particles of more than about 5% can make liquefaction significantly less likely than for clay-free soil [3].

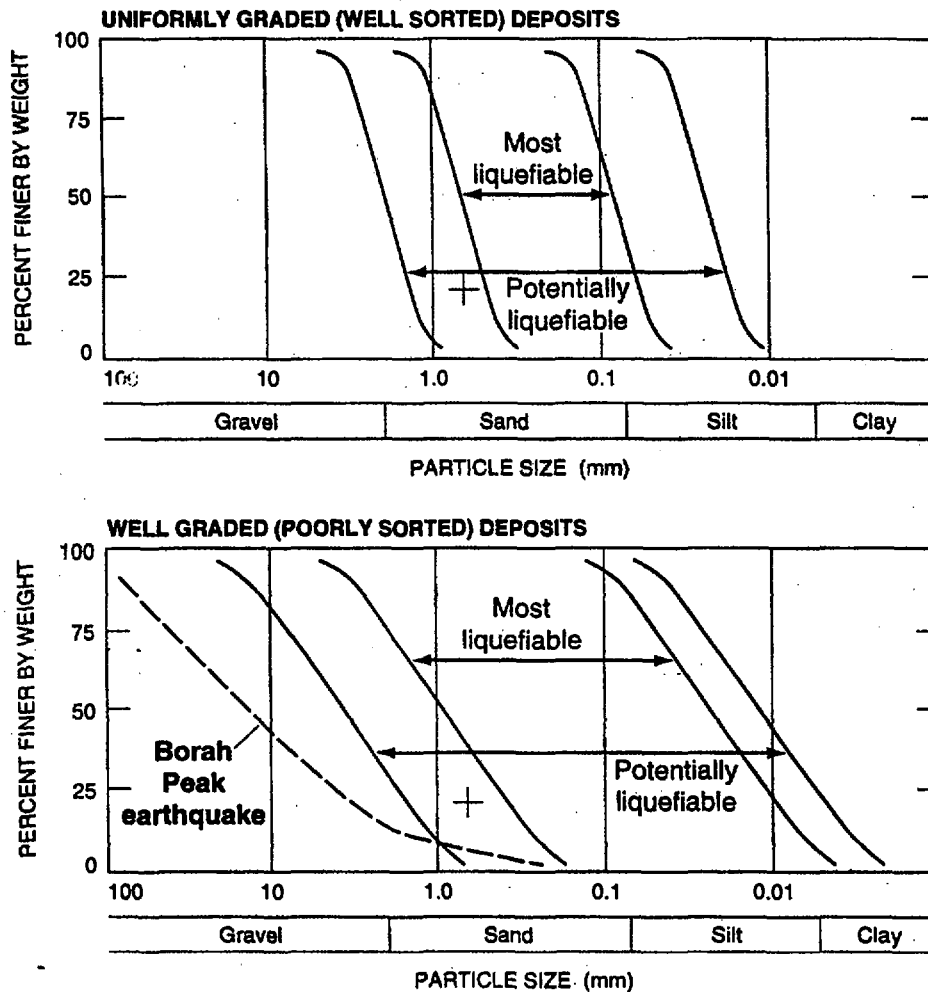

Figure 3-2. Curves showing grain sizes and gradations that are susceptible to liquefaction [3].

3.2.2 Density

Layering

For uniform grain size one can distinguish between well defined geometrical arrangements as illustrated by Figure 3-3. The densest layering, represented by cases 3 and 6, implies that the grains can not fall into denser positions and that shearing causes strong dilation and negative porewater pressure, which results in an increased effective pressure and strengthening. The porosity (n) is almost 0.26, which corresponds to a bulk density at water saturation of $2,250 \text{ kg/m}^3$. The loosest layering, represented by case 1, implies that the grains can move into denser and more stable positions and hence that porewater overpressure and liquefaction can be generated by shearing. The porosity is almost 0.48, which corresponds to a bulk density at saturation of $1,815 \text{ kg/m}^3$. Also cases 2, 4 and 5 corresponding to the densities $2,020$, $2,020$ and $2,190 \text{ kg/m}^3$, respectively, have a potential for structural collapse and liquefaction although the change in porosity will be very small and the associated increase in porewater pressure insignificant.

Six layering types with the geometry given below (center of spheres in the cell corners).

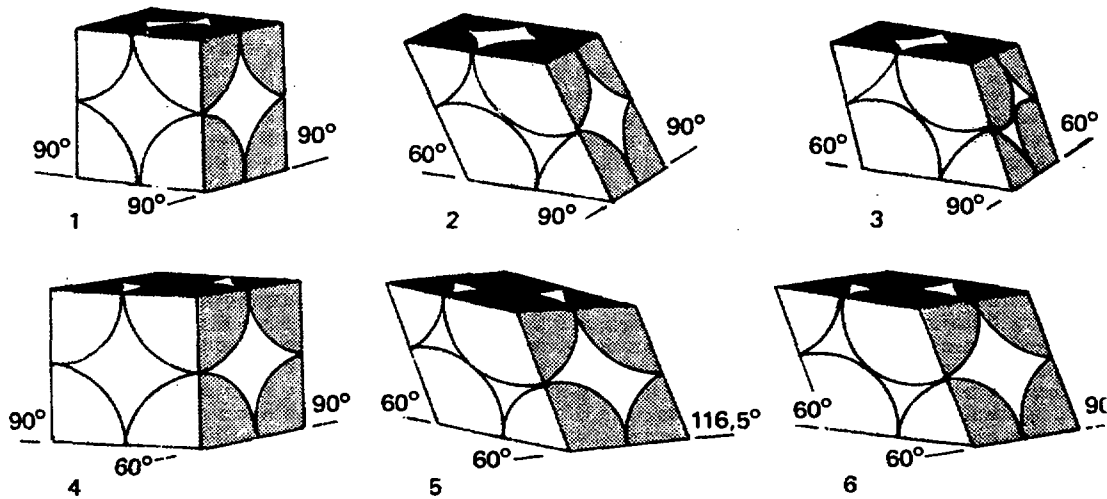

Case	Cell volume	Pore volume	Porosity, %
1	$8.00 R^3$	$3.81 R^3$	47.64
2	$6.93 R^3$	$2.74 R^3$	39.54
3	$5.66 R^3$	$1.47 R^3$	25.95
4	$6.93 R^3$	$2.74 R^3$	39.54
5	$6.00 R^3$	$1.81 R^3$	30.19
6	$5.66 R^3$	$1.47 R^3$	25.95

Figure 3-3. Six basic layering types assuming equally sized spherical grains.

Relative density

The layering of particles is a function of the density and soils susceptible to liquefaction are logically those of low density. A common measure of collapsibility is the relative density, RD , which is defined as in Equation (2). $RD=0$ corresponds to the most dense layering while $RD=1$ represents the most loose layering that a soil can have:

$$RD = (e_{max} - e) / (e_{max} - e_{min}) \quad (2)$$

where:

e = Void ratio

e_{max} = Void ratio at maximum density

e_{min} = Void ratio at minimum density

The state of looseness is often measured in situ by the Standard Penetration Test (SPT) blow-count method (American Society for Testing and Materials). The penetration resistance is measured as the number of blows required to drive a sampling tube 30.5 cm (1 ft) by dropping a 63.5 kg weight on it from 76 cm height. More than 30 blows in sand represents a high relative density and no risk for liquefaction while less than 10 blows represent loose layering and such low relative density that liquefaction can take place [3]. 10 blows has been found to correspond to a ϕ -value less than 30° [4]. 10 blows in silty clay is believed to correspond to a bearing capacity of around 100 kPa and an undrained shear strength of about 15 kPa [5].

These data can be interpreted in terms of bulk density at complete water saturation. Thus, for silt the void ratio e ranges between 0.3 and 1.4 ($n=25-60$), corresponding to the density range 1,600 to 2,200 kg/m³. For the earlier discussed density 1,815 kg/m³ e is 1.0 and the relative density RD hence 0.78, while for 2,020 kg/m³ e is 0.43 and $RD=0.14$. For 2,190 kg/m³, representing $e=e_{max}$ for equally large grains, $RD=0$. For well graded sand it is known that e usually has a small range, i.e. 0.15 to 0.4, while for relatively equally sized grains the range is higher and wider, i.e. 0.5 to 0.9. For till the e -range is usually 0.1 to 0.3 and RD very low.

A general conclusion from porosity considerations is that a bulk density of silty and sandy soils at water saturation that exceeds about 2,000 kg/m³ corresponds to higher SPT blows than 30 and hence to a very low susceptibility to liquefaction.

Influence of gradation and content of smectite clay

The grain size distribution of soils is of fundamental importance for the relative density as illustrated by the difference in void ratio between well graded and uniformly graded sand. Smaller grains fill the space between larger ones and cause less reduction in void ratio on shearing than when the grains are of equal size. This is demonstrated by the low RD for till.

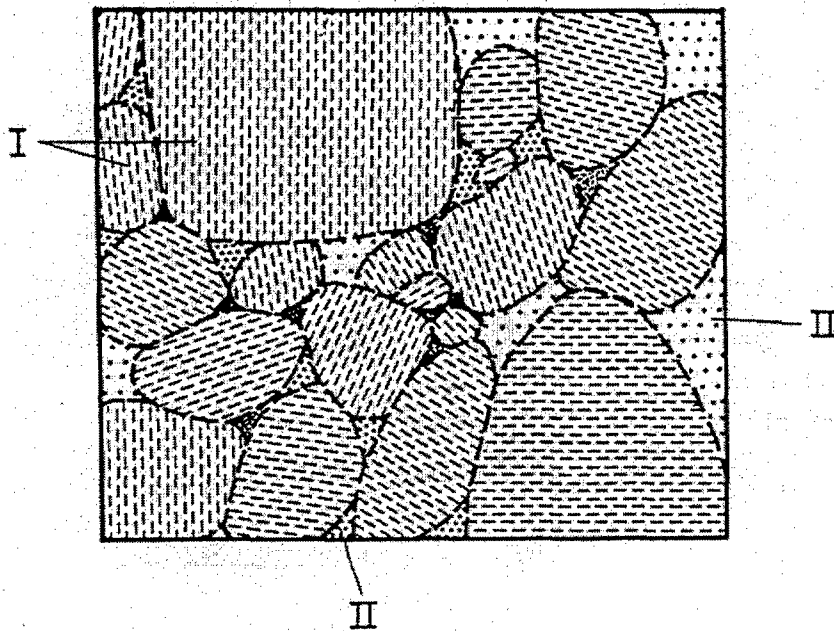

Figure 3-4. Schematic picture of buffer microstructure at saturation. I) Dense, expanded bentonite grain ("granule"). II) Clay gel formed in the voids between the grains [6].

When smectite clay gels fill the voids between the smallest grains, collapse of the system of larger grains is counteracted and the risk of liquefaction reduced. The aforementioned critical undrained shear strength of about 15 kPa for making silty clay susceptible to liquefaction indicates the high safety margin for buffer clay. Hence, since the undrained shear strength of MX-80 buffer clay with a density of about 2,000 kg/m³ is at least 500 kPa the risk of liquefaction is none. The dense microstructural constitution of buffer clay (Figure 3-4) is an obvious reason why collapse of the particle network will not take place at shearing: the dense aggregates dilate and tend to disperse, yielding negative porewater pressure and hence no risk of liquefaction.

For clayey tunnel backfill the microstructure is shown in Figure 3-5, which illustrates the case with less clay content than about 15% by weight, implying that the larger (ballast) grains constitute a continuous network and that the clay is contained in the voids between the grains.

If the ballast grains in Figure 3-5 form a dense network the backfill is dilatant with no risk of liquefaction. Referring to the preceding discussion on "relative density" the corresponding density is around 2,000 kg/m³. The role of the smectitic clay (MX-80 bentonite for the KBS-3 concept) used for preparing backfill is that it exerts a swelling pressure on the ballast grain network and hence prevents it from collapsing. This requires that the clay fills the majority of the voids between the ballast grains and that its density is sufficiently high. Theoretically, the clay content needs to be at least 5–6% but the difficulty in preparing a homogeneous mixture of clay and ballast makes it necessary to increase the clay content to at least 10–15%.

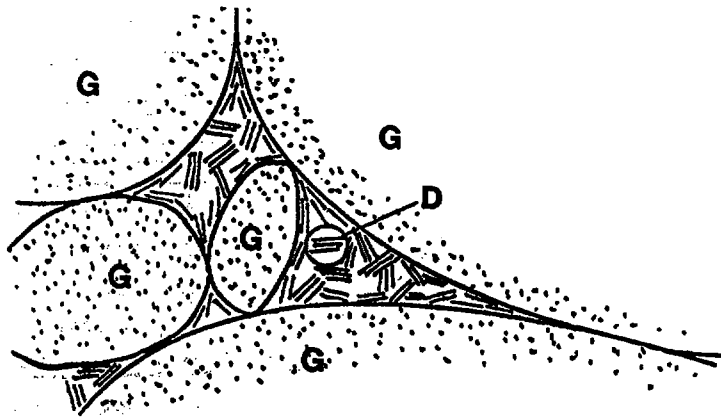

Figure 3-5. Schematic grain arrangement of clayey backfill. G=Ballast grains. D= Clay aggregate [6].

It is estimated that the required swelling pressure of the water saturated clay component is at least a few kilopascals for supporting the ballast grain network if the overburden pressure is low, and various investigations have shown that this corresponds to a density of MX-80 in Na-form of about $1,300 \text{ kg/m}^3$ [6]. However, for the Ca-saturated form, which may be obtained under ordinary groundwater conditions at deep disposal, the density required to yield this pressure is at least $1,500\text{--}1,600 \text{ kg/m}^3$. Microstructural analyses have shown that the clay density in mixtures of 10% (by weight) MX-80 bentonite and 90% crushed rock ballast ranges between $1,100$ and $1,700 \text{ kg/m}^3$ when the average bulk density at saturation of the mixture is $2,200 \text{ kg/m}^3$ [7], while it is estimated that the corresponding density range for the clay component is $1,000$ and $1,500 \text{ kg/m}^3$ if the bulk density is $1,900\text{--}2,000 \text{ kg/m}^3$. This would mean that, under Ca-saturated conditions, the clay will not support the ballast grain system. Still, the clay will prevent significant collapse of the system on shearing and it is therefore believed that backfills with a bulk density of about $2,000 \text{ kg/m}^3$ at saturation with salt groundwater with Ca as dominant cation will not undergo liquefaction if the clay content exceeds 15% and the bulk density is at least $1,900 \text{ kg/m}^3$. The critical clay content may in fact be as low as 5% as indicated by field evidence (cf. Section 3.2.1).

Considering the preceding discussion on “relative density”, a clay-free ballast with largely uniform grain size and a bulk density of about $1,800 \text{ kg/m}^3$ may represent a risk for liquefaction. If clay with an average density at saturation of less than $1,500 \text{ kg/m}^3$ is added and fills only a minor part of the voids this risk may still prevail, especially under salt conditions. These conditions will apply if the MX-80 content is less than 10–15% by weight and the bulk density of the backfill at water saturation is less than about $1,900 \text{ kg/m}^3$.

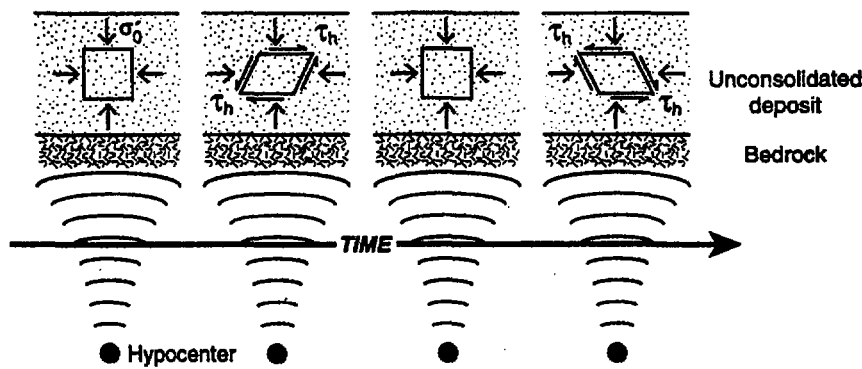

Figure 3-6. Field load conditions means initial vertical effective stress and horizontal shear stress due to existing earth pressure conditions and superimposed seismically induced cyclic shear stress [3].

3.3 Earthquake magnitudes related to liquefaction

3.3.1 Seismic processes yielding liquefaction

The energy propagation yielding shear stresses are indicated in Figure 3-6. It shows a vertical section through soil with shear stresses imposed by the propagating energy.

3.3.2 General experience

Primary seismological factors contributing to liquefaction are the amplitude of the cyclic shear stresses and the number of oscillations. They are related to the field conditions of peak acceleration and earthquake duration, which generally correlate with the earthquake magnitude. The very comprehensive study by Seed, Pond, Barreill and Davis, and Law of prehistoric liquefaction events manifested by clastic dikes in Idaho, Indiana and Illinois, suggest that the minimum earthquake magnitude required to yield liquefaction is in the range of $M=5$ to 9.5 [3].

The distance from surface evidence of liquefaction to the seismic energy source has been determined by several investigators yielding the graph in Figure 3-7, which shows that an earthquake with $M=5$ may cause substantial liquefaction within a (horizontal, hypocentral) distance of 2 km, while the corresponding distance for one with $M=7$ is 20–100 km [3]. A measure of the energy imposed on the ground by earthquakes is the peak surface acceleration, which appears to be 0.4 to 0.5 g at 20 km hypocentral distance for $M=7.5$ to 8.0. It exceeds 1.0 g at smaller distances than 10 km for this magnitude interval.

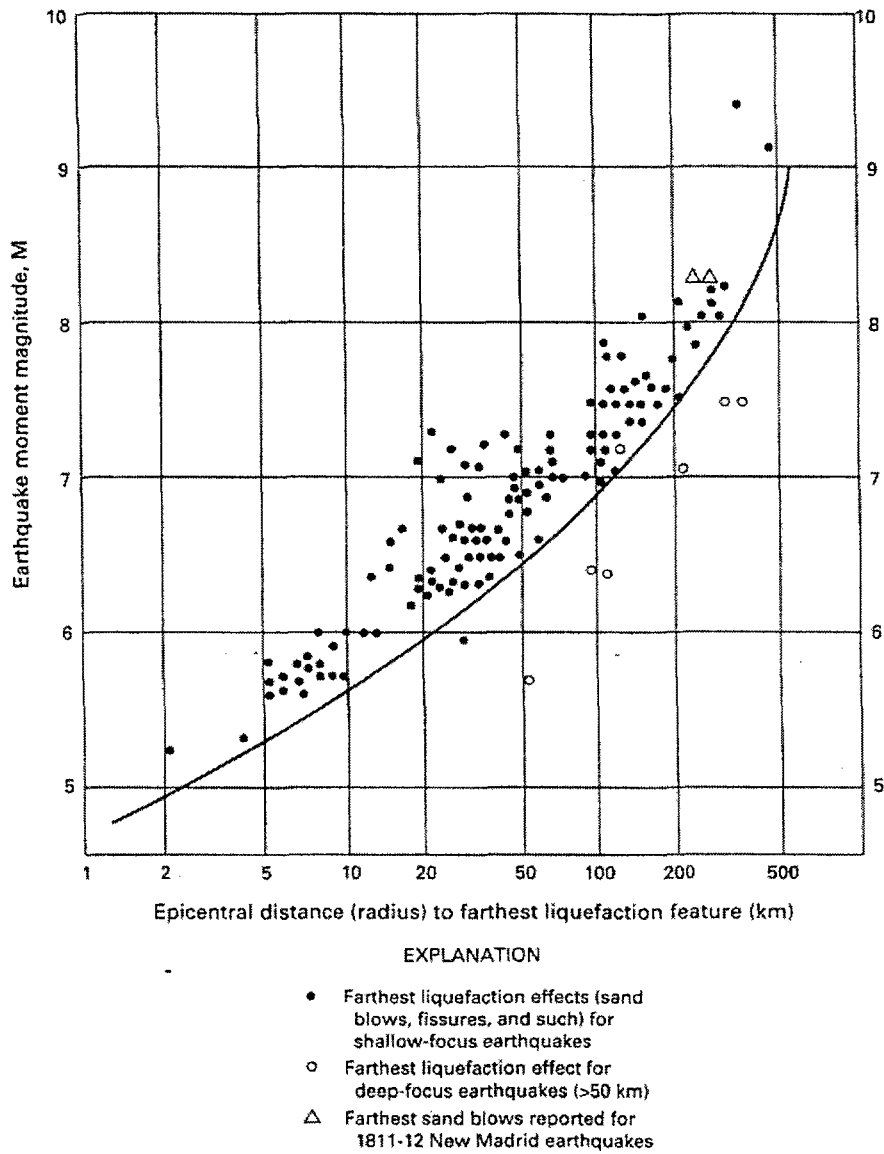

Figure 3-7. Relationship between earthquake magnitude (M) and horizontal distance from earthquake epicenter to the farthest liquefaction event [3].

3.3.3 Rock structure considerations

Major tectonic and block boundary lines are those represented by 1st and 2nd order discontinuities (Regional and Major regional/Major local zones respectively according to SKB terminology), which represent regional fracture zones with an extension of several kilometers and a spacing of several hundred meters [5]. Their average hydraulic conductivity is rather high while they are locally very tight due to gouge. Earthquakes are believed to be associated with momentaneous shearing of such weaknesses and it has been estimated from seismic data that $M=5$ may correspond to a shear displacement of about 0.2 m. A cubic rock block with 10 km edge length would undergo a corresponding shear strain of $2E-5$. There are indications that $M=8$ corresponds to 1 m shear displacement, yielding an average shear strain of such a block of $E-4$. $M=7$ would correspond to a shear strain of $7E-5$. For blocks with 100 km edge length $M=7$ and 8 the strain is $7E-6$ and $E-5$, respectively.

Earthquakes of high magnitude in Sweden are believed to be related to movements along 1st order discontinuities of the types represented by the major river valleys, which have a spacing of 50 to 100 km. Applying the graph in Figure 9 one concludes that seismic events with $M<6$ are not expected to yield liquefaction of potentially unstable soils at smaller distances from such discontinuities than about 15 km, while for $M>7$ this distance exceeds 100 km. This means that the entire region between neighboring 1st order discontinuities may yield liquefaction of unstable backfills in a repository and hence that it can not be located so that the risk of liquefaction can be eliminated if one needs to consider earthquakes with $M>6$. Naturally, it appears suitable to establish a repository at half distance between such discontinuities for minimizing tectonic effects irrespective of the seismic energy.

3.3.4 Earthquake-related porewater pressure

Measurements of the magnitude and earth acceleration and related pore water pressures for about 20 earthquakes have been made in the Kamaishi underground laboratory in northeastern Honshu, Japan [8]. The magnitude was up to about $M=5$ and the corresponding temporary rise in piezometric pressure about 35 kPa. The maximum acceleration was concluded to drop significantly with depth. Thus, for 650 m depth it was estimated to be $\frac{1}{4}$ to $\frac{1}{2}$ of that at the ground surface while there was almost no reduction at 150 m depth. It was concluded that the required crustal strain to cause changes in water pressure of this order of magnitude is $E-8$.

Assuming proportionality between shear strain and rise in porewater pressure one would expect that a strain of $E-5$, corresponding to $M=8$ for the case of regional blocks with 100 km edge length, would increase the water pressure in the rock by one thousand times, i.e. to 35 MPa. This would imply that the buffer and backfill become exposed to a very high hydraulic overpressure that increases the porewater pressure by the same amount and reduces the effective pressure to zero, hence yielding a complete loss in shear strength of both the buffer and backfills. This reasoning is overconservative, however, since the shear strain is not uniformly distributed over the block volume and the generated groundwater pressure is not momentarily transferred to the porewater. Still, it is believed that earthquakes with $M>6$ may cause a temporary increase in porewater pressure and reduction of the stability of tunnel backfills. The matter requires further investigation for complete resolution.

3.3.5 Earthquake effects on slopes

In slopes, shear stresses generated by seismic events will add to the natural deviatoric stresses that prevail under static conditions and cause liquefaction, failure and flow of the shallow part as illustrated by the Alaskan earthquake in silt and slightly clayey silt [9]. It is important that this and other investigations demonstrate that fluid conditions and large soil movement can occur even when the surface is inclined as little as by 0.1 to 5%. The Alaskan liquefaction had an enormous extension due to the very large energy set free ($M=9.2$).

The consequence of surface inclination is that if the upper surface of the tunnel backfill in a repository is separated from the tunnel roof and inclined even very slightly, liquefaction will cause flow of the unstable part of the backfill until the surface becomes horizontal. Through this, the distance between the backfill surface and the tunnel roof will increase over part of the tunnel length and decrease over the remaining part. This will lead to an increased risk of rock fall and disintegration of the tunnel roof.

3.4 Experimental

Liquefaction tests have been performed by JNC*, using mixtures of 70% bentonite and 30% sand, the bentonite having a smectite content of about 40%. The mode of investigation was to prepare a cylindrical sample with a density of 2,000 kg/m³ at saturation in a triaxial cell and expose it to 0.1 Hz axial cyclic stress waves with an amplitude ratio of 0.241, 0.145 and 0.100. The ratio is expressed as the deviator stress divided by the effective confining pressure, which changes with the generated porewater pressure. The highest ratio gave very large axial strain (10%) while the lowest gave less axial strain than 1%.

The results can be summarized as follows:

1. Porewater pressures were generated, the increase being nonlinearly related to the number of cycles (Figure 3-8). The maximum recorded pressure was about 0.6 MPa.
2. Liquefaction was not obtained for up to 1,000 stress cycles.
3. The required number of stress cycles to reach liquefaction could be determined by extrapolating the increase in porewater pressure with the number of stress cycles assuming the relationship to be linear. This gave the expression in Equation (3):

$$N/20 = (R_1/R_{20})^\eta \quad (3)$$

where:

N = Number of cycles to reach liquefaction

R_1 = Stress amplitude ratio at liquefaction

R_{20} = Stress amplitude ratio for 20 cycles

η = Experimental constant

* Pers. Comm. Dr Hirohisa Ishikawa, JNC (under publication).

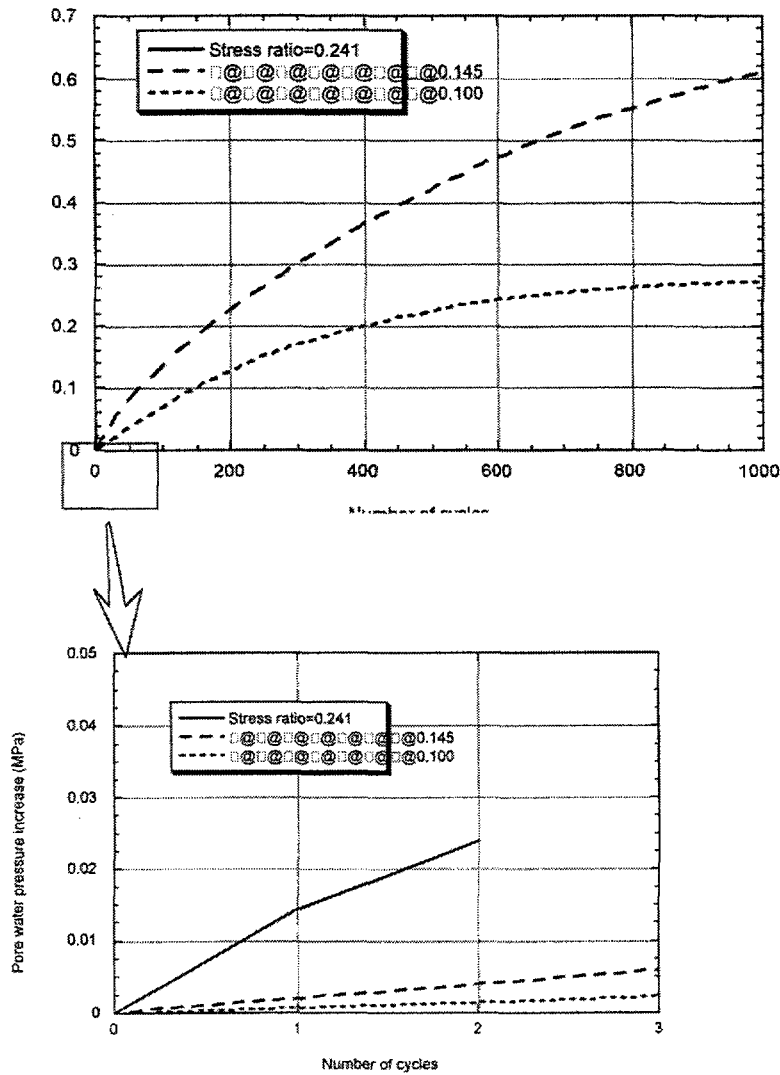

Figure 3-8. Increase in porewater pressure with increased number of stress cycles at the JNC experiment. The experiment with the stress ratio 0.241 was terminated early but is expected to have yielded high porewater pressure after some tens or hundreds of stress cycles.

The experiments gave the diagram in Figure 3-9 from which one can derive the required number of stress cycles to obtain liquefaction. One finds that liquefaction is expected for about 200 stress cycles at the stress ratio 0.241, while the number is 2,100 for the stress ratio 0.145 and 4,100 for the stress ratio 0.100. The experimental constant η was evaluated as -3.11 .

The stress ratio corresponding to real earthquakes is not known but one can estimate the probable number of stress cycles by considering that the duration of a seismic event of this sort may be some tens of seconds. Thus, using the JNC oscillation value 0.1 Hz, which can be considered to represent an average probable frequency, the number of cycles would be less than 5. The risk of liquefaction would hence be negligible for the investigated stress ratios. If the frequency would be appreciably higher, i.e. 1–10, these ratios would be able to yield liquefaction of the JNC material under the applied stress conditions.

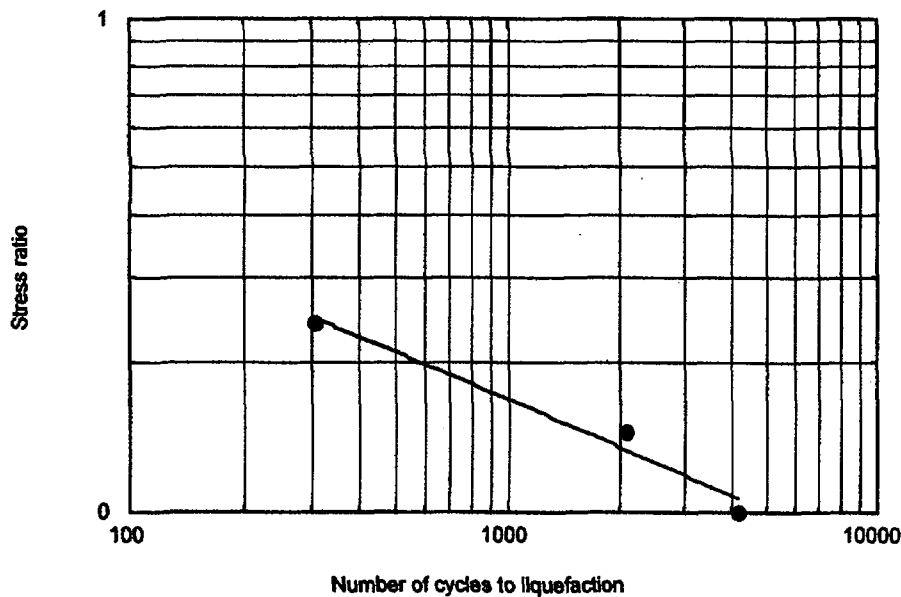

Figure 3-9. Relationship between number of cycles to liquefaction and stress ratio as derived from the JNC experiments.

One can draw two major conclusions of the tests: Firstly, that backfills with a high clay content *can* in fact undergo liquefaction, and secondly, that the duration of an earthquake must be sufficient to produce a large number of loadings of equal amplitude. A single earthquake yields attenuation of the amplitude and the number of stress cycles of practical importance for liquefaction is hence limited.

It should be pointed out that the JNC tests, which were made by use of a triaxial cell in which the samples were confined and exposed to a cell pressure that produced compression, represent the special case of a totally confined soil exposed to strong vibrations in conjunction with compression. This case is not applicable to the buffer in KBS-3 repositories for two reasons. Firstly, the compression of a steep discontinuity of type D4 intersecting a deposition hole is too small to impose significant compression of the buffer, and secondly that it will be moved upwards by rock convergence without yielding a very high porewater pressure. As to the backfill, the required compression for generating critically high porewater pressures would require stronger convergence of the rock than is possible, assuming that the deposition tunnels are not intersected by thick longitudinal discontinuities of type D3 filled with compressible clastic material.

4 Discussion and conclusions

4.1 Relevance

Recent as well as ancient examples in nature of liquefaction of soils similar to backfills in tunnels and shafts in a repository, and the JNC experiments with buffer-like clay demonstrate that the issue of liquefaction is relevant.

The basic stress/strain relationship for soils and the effective stress concept are valid for buffers and backfills also with respect to liquefaction. Hence, the model of compression with accompanying critical porewater pressure yielding liquefaction is relevant.

4.2 Seismic energy considerations

A major question is whether the seismic energy is sufficient to produce liquefaction of buffers and backfills of the intended densities and if the conditions on site make liquefaction possible. As to the energy it is concluded from the literature [3] that an earthquake magnitude of about 5 is required for yielding liquefaction of sandy soil and 7 for gravel. Seismic events of the latter magnitude may occur in certain parts of Sweden before or in conjunction with future glaciations and deglaciations.

The seismic energy is determined by the amplitude and duration of the oscillations. For single earthquakes the number of stress cycles of sufficient magnitude to produce liquefaction is expected to be less than 100, which puts a limit to the build-up of porewater pressures that eventually may cause liquefaction. If liquefaction has not taken place in the first minute after the onset of a major earthquake it is not expected to occur. Possibly raised porewater overpressures will subsequently dissipate in conjunction with an increase in effective stresses and stable conditions reappear.

4.3 Susceptibility to liquefaction of buffers and backfills under repository conditions

Buffer clay

A necessary criterion for liquefaction is that the soil must undergo compression and the question is hence whether the seismically induced shear stresses will yield denser layering and a concomitant increase in porewater pressure. This applies to both clay-rich buffer and less clayey backfills if the load conditions are such that compression will take place, which implies that the shear stress ratio is sufficiently high and also that the stress cycles are sufficiently numerous. For MX-80 buffer with a density exceeding 1,700–1,800 kg/m³ at saturation this criterion does not apply because the load on the buffer clay exerted by the overlying backfill is not sufficient to produce compression. Intense shearing caused by seismic events will instead tend to cause microstructural dispersion and an increased surface area of the clay which improves the degree of hydration and yields expansion. This effect is believed to be valid also for any equally dense clay with at least 50% expandable clay minerals like the Friedland clay [7].

One may object that the porewater pressure increased in the experiments with JNC material in a fashion that may have led to liquefaction if the number of cyclic shear stress cycles had been higher. However, the experimental load conditions were not representative of those of the buffer in a repository: the axial stress was maintained at the level required to prepare (consolidate) the samples while this load is caused by the low-expansive overlying backfill in a repository.

Backfill

Tunnel backfills are only exposed to a load corresponding to their own weight and the vertical effective stress in the uppermost part is therefore very low if the content of expandable minerals is less than 10–15%. Development of liquefaction is increasingly difficult with depth because the higher static vertical effective stress exerted by the overburden greatly increases the resistance of deeper soil layers to shearing and deformation. In contrast to the buffer clay, which is effectively confined in the deposition holes and covered by tunnel backfill, the conditions for the backfill are similar to those in Figure 8, i.e. with a free upper surface. If the density is low compression may take place by earthquake-induced shearing but this requires that the layering of the grains can be increased under the prevailing low vertical stress.

A clay-free ballast with largely uniform grain size and a bulk density of about $1,800 \text{ kg/m}^3$ may represent a risk for liquefaction. If the voids between the ballast grains contain expandable clay with an average density at saturation of less than $1,500 \text{ kg/m}^3$, which is the case for mixtures of crushed rock ballast and 10–15% MX-80 bentonite, this risk may still prevail. However, the low overburden load is not expected to yield critical conditions although there is no experimental proof.

Field experiments in the underground laboratories at Stripa and Äspö have shown that backfills with 10–20% MX-80 can be compacted to a bulk density that corresponds to $2,030$ to $2,350 \text{ kg/m}^3$ at water saturation [7]. This means that not even the lowest density is expected to make the backfill susceptible to liquefaction.

By increasing the content of expandable clay to 30%, which has been recommended for providing sufficient support to the tunnel roof [7], the swelling potential of the backfill, in which the ballast grains will be dispersed in the clay matrix, makes it resist compression under the prevailing low overburden pressure even at a bulk density of $1,800 \text{ kg/m}^3$. This is evidenced by the fact that the swelling pressure of such backfills exceeds 50 kPa even in Ca-form and with highly saline porewater [6]. Experience shows that mixtures of 30% MX-80 bentonite and 70% crushed rock backfill can be compacted in tunnels to an average density of $2,070 \text{ kg/m}^3$, which hence represents very safe conditions with respect to liquefaction. Equally or more safe conditions can be obtained by using natural clays with 40–50% expandable minerals, like the Friedland clay [7].

4.4 General conclusions

The necessary prerequisites for liquefaction of buffers and backfills exist but the intended densities and the stress conditions practically eliminate the risk of liquefaction for earthquakes with magnitudes up to 7–8 and normal duration time. For buffers rich in expandable minerals it would be possible to reduce the density at water saturation to 1,700–1,800 kg/m³ without any significant risk of liquefaction, while the density at saturation of backfills with 10–15% expandable clay should not be lower than about 1,900 kg/m³. For other reasons the proposed densities of both buffers and backfills will significantly exceed these minimum values. A major conclusion is hence that there is no risk of liquefaction of the engineered soil barriers in a KBS-3 repository even for very significant earthquakes.

References

1. **Seed H B, 1968.** Landslides during earthquakes due to soil liquefaction. *J. Soil Mech. Found. Eng. Div., Am. Soc. Civil Engineers*, Vol. 94, SM5 (pp. 1055–1122).
2. **Pusch R, 1969.** Geotechnical aspects of the interpretation of distorted strata in Silurian deposits. *Acta Univ. Stockholmiensis, Stockholm Contributions in Geology* Vol. XXIV:2.
3. **Obermeier S F, 1996.** Use of liquefaction-induced features for paleoseismic analysis. *Eng. Geol.* Vol. 44, Nos. 1–4., Elsevier Publ. Co.
4. **Peck R B, Hanson W E, Thorburn T H, 1953.** *Foundation Engineering.* John Wiley & Sons.
5. **Terzaghi K, Peck R B, 1948.** *Soil Mechanics in Engineering Practice.* John Wiley & Sons.
6. **Pusch R, 1994.** *Waste Disposal in Rock. Developments in Geotechnical Engineering*, 76. Elsevier Publ. Co. ISBN:0-444-89449-7.
7. **Pusch R, 1998.** Backfilling with mixtures of bentonite/ballast materials or natural smectitic clay? SKB Technical Report TR-98-16, SKB Stockholm.
8. **Shimizu I, Osawa H, Seo T, Yasuike S, Sasaki S, 1996.** Earthquake-related ground motion and groundwater pressure change at the Kamaishi mine. *Eng. Geology*, Vol. 43 (pp. 107–118).
9. **Youd T L and Bartlett S F, 1991.** Case histories of lateral spreads from the 1964 Alaska earthquake. Proc. 3 Japan/US workshop on Earthquake Resistant Design of Lifeline Facilities and Countermeasures for Soil Liquefaction. Nat. Cent. for Earthquake Engineering Research, Tech. Rep. NCEER-91 (pp. 175–189).

ISSN 1404-0344

CM Digitaltryck AB, Bromma, 2000