

RESONANT BPM FOR CONTINUOUS TUNE MEASUREMENT IN RHIC¹

M. Kesselman, P. Cameron, J. Cupolo
BNL, Upton, NY 11973, USA

Abstract

A movable Beam Position Monitor (BPM) using shorted stripline Pick-Up Electrode (PUE) elements has been resonated using matching stub techniques to achieve a relatively high Q resonance at about 230MHz. This PUE has been used in a feasibility study of phase-locked-loop tune measurement [1], using a lock-in amplifier and variable frequency generator to continuously track betatron tune in RHIC, as well as to observe Schottky signals of the Gold beam. The approach to providing a high Q PUE for difference mode signals, simulation studies, and the results of initial tests will be presented.

1 BACKGROUND

Monitoring tune during ramp-up of RHIC using a high Q resonator (Q=4000) to observe Schottky signals at 2GHz requires tracking and averaging FFT analysis of signals that are sweeping over a large range of frequencies. An alternate approach was conceived that would utilize a BPM with a resonant difference mode, and a damped sum mode. By resonating the difference mode, the BPM can be made more sensitive to transverse beam motion, and the tune can be extracted from the betatron oscillations by analyzing the beam spectrum. To accomplish this a Q near 100 is required to develop sufficient signal sensitivity.

2 RESONATING THE BPM

A resonant frequency near 230MHz was chosen to provide sensitivity to the Schottky spectral lines near a low spectral power frequency for the beam. It is necessary to resonate the BPM in the difference mode. High Qs are required to obtain reasonable signal levels. Utilizing a discrete component tuned circuit results in Qs that are lower than required. An alternate technique was investigated utilizing the reactive characteristics of a transmission line. To obtain high sensitivity a very high impedance at the pick-off nodes of the shorted strip line PUE is required. Assuming these nodes "open", a half wave cable would provide an "open" at the other end. Therefore, placing a half wave cable from one PUE to the opposite PUE, could resonate the difference mode of a BPM. It would then become a matching problem to extract power from the PUE nodes.

2.1 Simulation

To aid in the design of a resonant BPM, a simulation was developed using ORCAD and PSpice. The

simulation schematic is shown in Figure 1. Lossy transmission line models were used to simulate the coaxial cables and the BPM stripline. The characteristics of the coax were taken from an Andrew® catalog for Heliac® cables [2]. The resistance was modified for frequency effects by estimating the losses per 100 meters at about 250 MHz. An equivalent cable resistance was then calculated and used as a resistance parameter per meter (0.98 Ohms). To simulate the response to the difference mode, two current sources were used to inject signals into the stripline termination points. These were set to provide differential excitation in an AC analysis. To investigate matching impedance, two current sources were used at the Hybrid input ports and set to provide differential excitation. The AC sources were set to +/- 1 Amp thereby yielding output voltages that read directly in Ohms for impedance runs, and gain for signal resonance runs. Care was taken to assure that only one set of current sources was active at a time.

Global parametric runs were performed to yield output plots that depicted the effect of adjusting the tuning stub length, and the quarter wave matching sections. Trial and error yielded half wave lengths and quarter wave lengths that resonated near 225MHz. Resonating at 225MHz was selected to yield a base-band signal when mixed with an RF signal 8 times the RF. A subsequent design was tuned to 238.7MHz using capacitor loaded stubs.

It was interesting to note that when the stub was tuned exactly to the quarter wave length a poor match was obtained with little output (due to the virtual short). In addition, the stub could be tuned high or low for a good match (50 ohms). An example of such a result is shown in Figure 2. This indicates that there are two resonances that can be matched by the tuning stub. One above the quarter wave frequency and one below. This permits setting the vertical and horizontal resonances at slightly different frequencies while using the same cable lengths for the "half and quarter wave" sections in each plane (actual lengths are slightly different from the nominal to achieve proper match).

Once the stubs are cut to match 50 Ohms, the response will fall at the resonant frequency, and the unloaded Q is reduced by a factor of two (see figures 3 and 4).

The simulation provided for a 3/8 inch foam Heliac® cable for use in the "half wave" section. Simulations show an improvement in Q over using 1/4 inch foam Heliac.

¹ Work performed under the auspices of the U.S. Department of Energy.

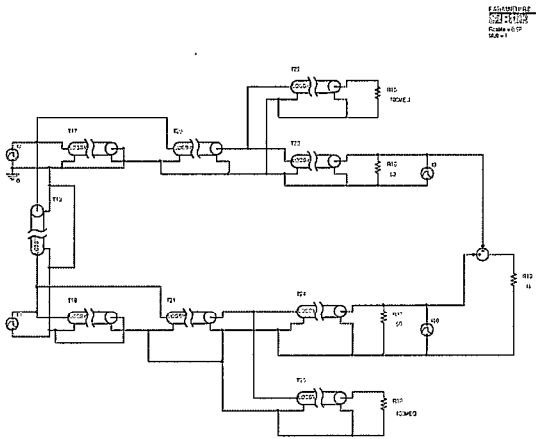

Figure 1 – Pspice Simulation Circuit used to analyze the resonant BPM.

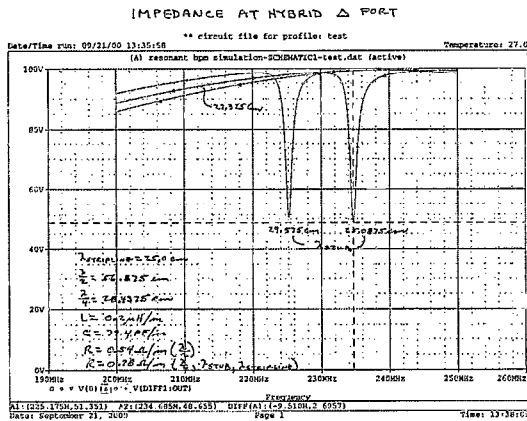

Figure 2 – Simulation of Impedance at Hybrid Difference Port. Note; poor match with stub cut to exactly quarter wave.

2.2 Testing

Testing was done with different cable lengths than shown as simulation results. The stub tuned BPM concept was tried in the laboratory using a standard RHIC BPM. The BPM was stimulated by an RF source coupled by a copper center conductor mounted between two matching sections that were permitted to move slightly with respect to the PUEs. A photo is shown in figure 5.

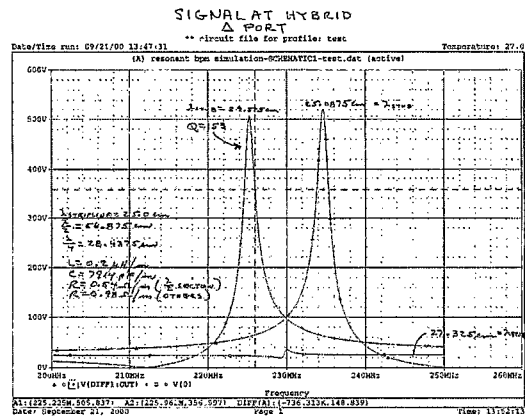

Figure 3 – Simulated Signal at Hybrid Difference Port. Response to difference mode signal of unit value. Note; very little response with stub cut to exactly quarter wave.

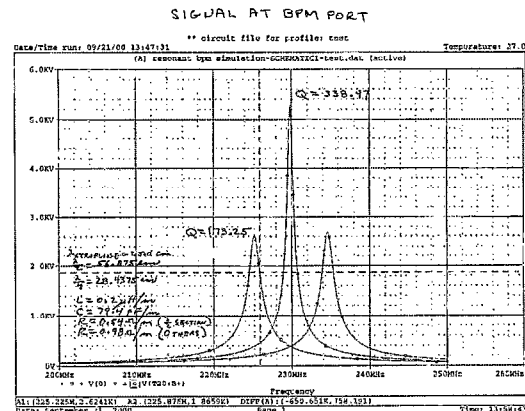

Figure 4 – Simulated Signal at BPM Port. Response to difference mode signal of unit value. Note; unloaded Q at resonance is twice loaded Q with shifted resonant response.

Two movable RHIC BPMs, one in the “Blue” and one in the “Yellow” Ring were resonated using this technique. The BPM was tuned in place in the Ring using a network analyzer and cutting the stubs about a tenth of an inch at a time. When a sufficiently low reflection coefficient was achieved the cutting process was stopped. A match yielding better than -38dB reflection coefficient was achieved as shown in figure 6. This corresponds to about a 2.5% mis-match to the characteristic line impedance. A Q of the order of 120 was achieved. Figure 7 shows real tune data achieved during a ramp-up of RHIC.

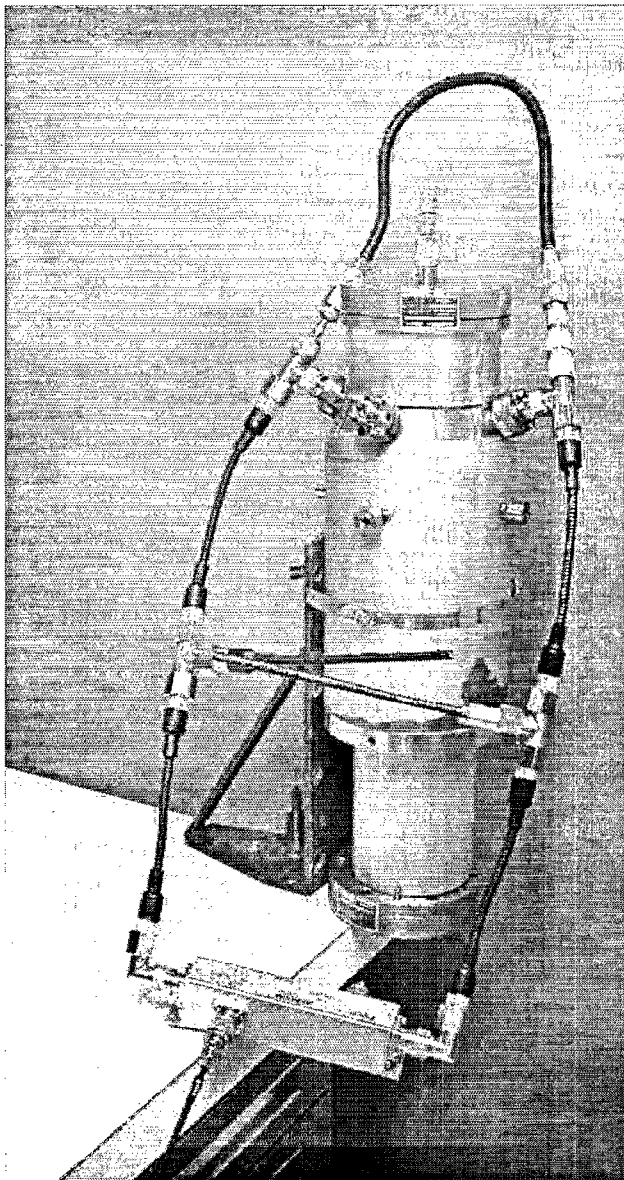

Figure 5 – Photo of stub tuned resonant BPM showing testing configuration. Matching sections at each end carry a RF signal through a center conductor to a termination. Output is taken from the difference port of a Hybrid transformer.

3 SUMMARY

A BPM has been resonated using a stub tuned approach to achieve relatively high Q tuning characteristics, a completely passive approach, and a match to a 50 Ohm load. Simulation, testing and design methodology have been presented. Initial tests in the RHIC show feasibility for a continuous tune measurement system based upon this technique.

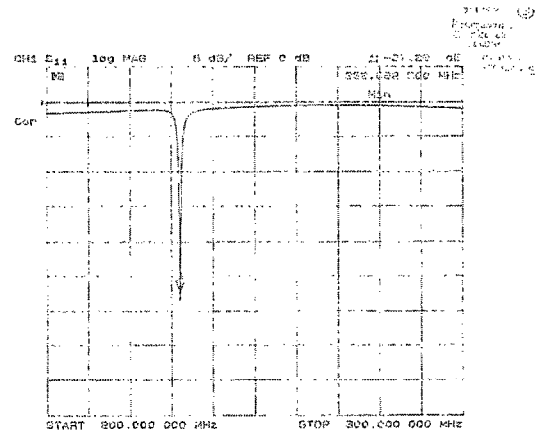

Figure 6 - Reflection coefficient for the Horizontal Plane Hybrid Difference port, Movable BPM located at 2 O'clock on the Yellow beam line

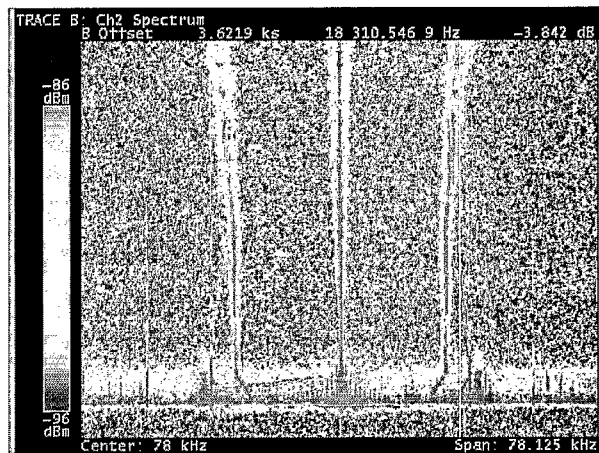

Figure 7 – Spectrum from acceleration ramp showing a revolution line (center), and betatron sidebands to either side. Beginning of ramp is at top, broadband green blending into yellow at bottom is noise due to beam loss at transition. Tunes are coupled so that both horizontal and vertical show up in this vertical spectrum. Lines also appear at .25 and .375 with increased losses, suggesting beam in islands.

4 ACKNOWLEDGEMENTS

The authors would like to acknowledge R. Sikora for his assistance with hardware modifications and cable construction.

5 REFERENCES

- [1] Peter Cameron et-al, "Tune Feedback at RHIC", to be published at this conference
- [2] Andrew Corporation, Oakland Park, IL 60462; <http://www.andrew.com>