

ub



SURVEY AND ALIGNMENT FOR THE SWISS LIGHT SOURCE

F.Q. Wei, K. Dreyer, U. Fehlmann, J.L. Pochon and A. Wrulich
SLS / Paul Scherrer Institute
CH5232 Villigen PSI
Switzerland

ABSTRACT

The Swiss Light Source (SLS) is a dedicated high brightness synchrotron light source currently under construction at the Paul Scherrer Institute (PSI) in Villigen [1]. It will be commissioned in 2001. The accelerator complex includes a 2.4 GeV electron storage ring (SR) with 288 m circumference, a full energy injection booster synchrotron (Booster) and a 100 MeV linear pre-accelerator. The general alignment method and first results of the network measurements are presented. A laser tracker LTD500 is mainly adopted for network measurements and the alignment of storage ring components.

1. Introduction

The SLS, shown schematically in figure 1, has a 100 MeV linac, transfer lines, a booster with 270 m circumference and the storage ring with 288 m circumference. As a particularity of the SLS design, both booster and storage ring have similar radii, permitting the installation within the same shielding tunnel. The lines marked in green indicate the planned beamlines of the first phase from insertion devices i.e. wigglers, undulators and bending magnets. The lines marked in red indicate possible second phase beam lines.

On June 18 1997, the SLS was officially approved by the Swiss Parliament and the realization phase of the project was started.

In July 1998, ground breaking of the SLS building was performed. Only one year after this date, July 1999, the SLS building was ready for machine installation. Figure 2 shows an inside view of the accelerator tunnel. Now the booster supports and the

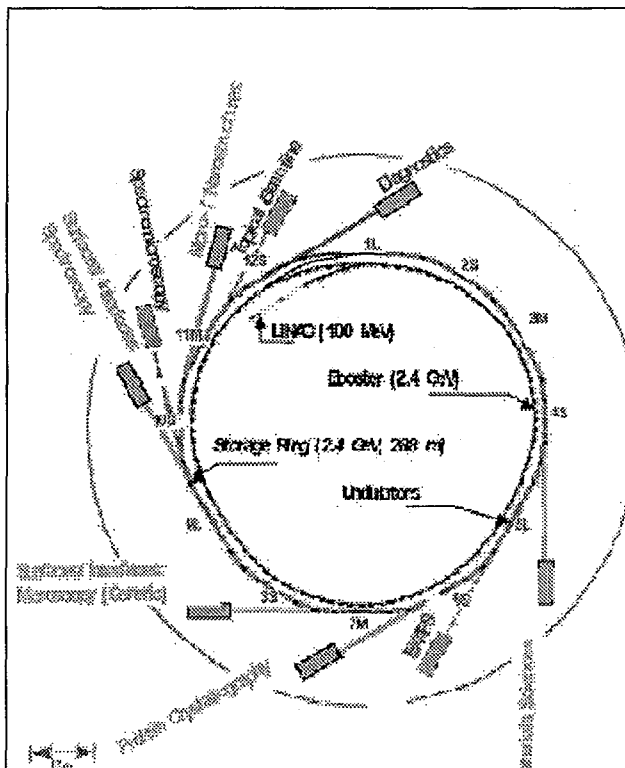

Fig. 1. SLS layout

support pedestals of the storage ring girders have been aligned. In the passed year a main instrument for survey and alignment, a laser tracker LTD500, was delivered and tested. Using the laser tracker and a precision levelling N3 the tunnel network has been measured twice. The results are good enough for pre-alignment of the machine components. In spite of the tight schedule we are confident to have the first stored beam at the beginning of 2001.

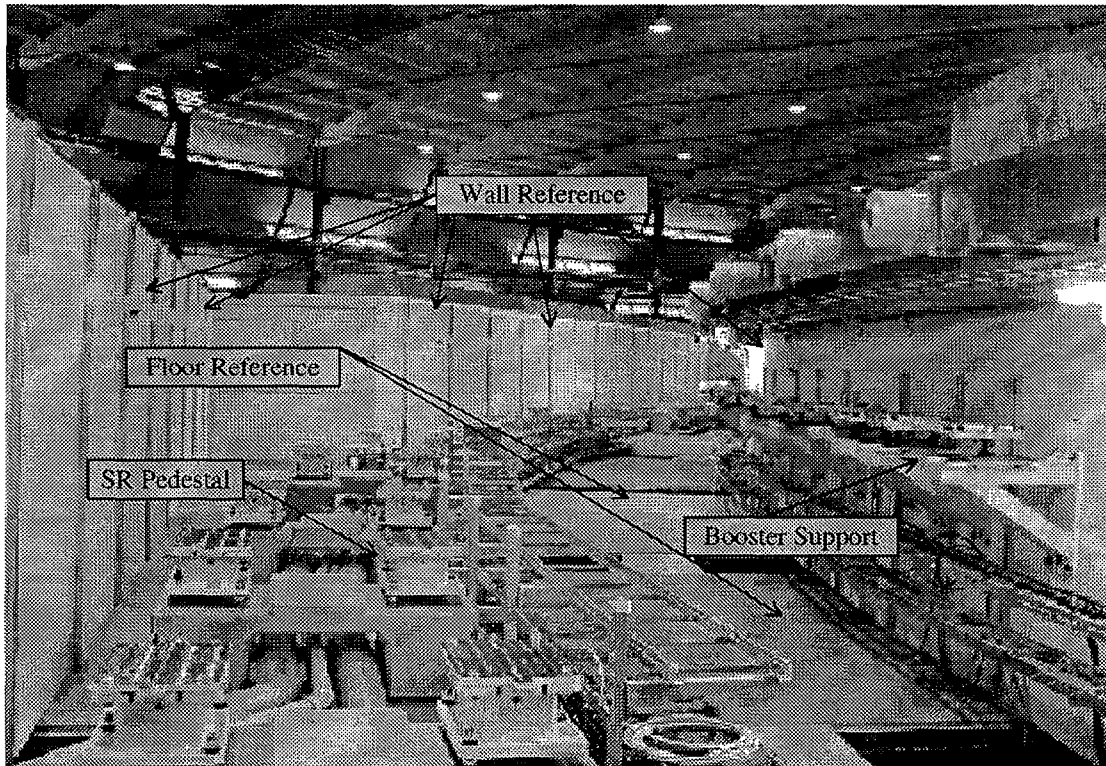

Fig. 2 Inside view of the SLS tunnel in August 1999

2. SLS Alignment Network Layout

The SLS alignment network (Fig. 3) consists of the linac network, the tunnel network and the experimental network. They are separated by the tunnel shielding wall. There are 3 to 4 datum in each network. Those datum were built and measured before construction of the shielding wall and the final floor in January 1999. Most of the wall references were mounted on the wall and all the floor references (Fig. 4) were inserted into the final floor in May 1999. The linac network

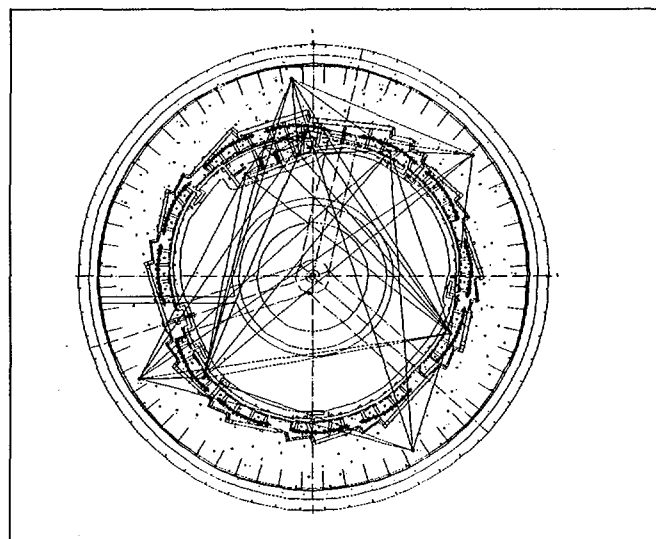

Fig. 3. SLS Alignment Network

consist of 3 floor references and 3 wall references. The tunnel network consists of 102 wall references and 53 floor references. The experimental network consists of 40 wall references and 111 floor references. Most of the floor references of the experimental network are located in parallel lines to the planned beamlines. The floor and wall references are made of bronze CuSu 10.

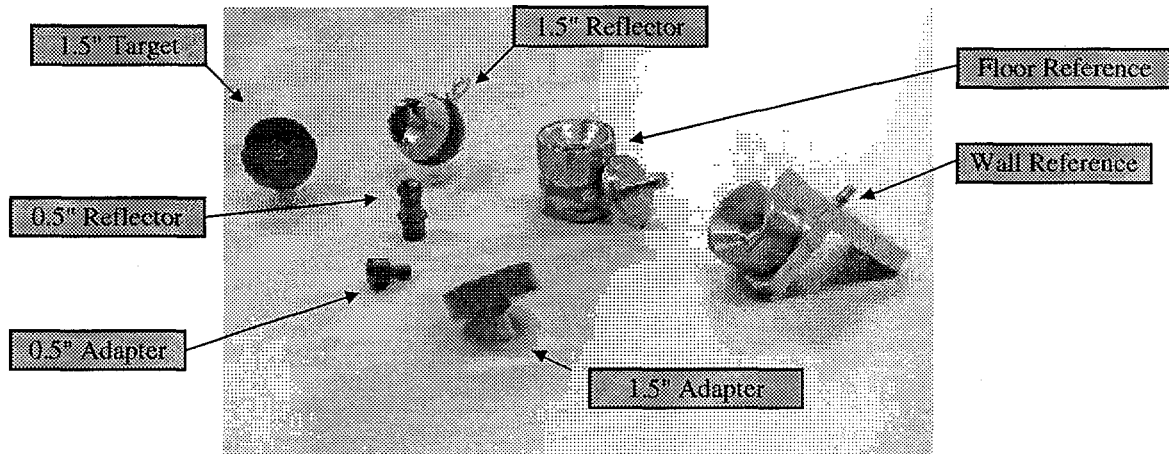

Fig. 4 References, reflectors and adapters

3. Laser Tracker LTD500

3.1 LTD500 Measurement principle

The basic measurement principle of the LTD500 is the polar point determination as commonly used in surveying. The sensor unit reads the angles from vertical and in horizontal direction, the Laser interferometer provides high accuracy measurements for the distance. Because interferometer measurement is a counting process, which registers the relative movement of the reflector from an initial distance, a well known starting point (Home Point or 'Bird Bath') must be defined by calibration. As another consequence the laser beam must be reflected continuously to its source, which is done by tracking the reflector. Tracking is done by the controller unit, which continuously turns the head of the sensor to follow the reflector movement.

3.2 LTD500 Hardware

The main components of the LTD500 are the sensor unit, the controller and the application processor (LapTop running Axyz-Software). The sensor unit contains encoders for angle measurement of the two orthogonal axis and a laser interferometer (hetero-dyne type) for distance measurement. The tracking head has direct drive DC motors for remote-controlled rotation around its axis. The sensor unit is connected with two cable to the controller, which contains the system's main electronics i.e. power supply, motor amplifiers, tracker processor running firmware, interferometer counter and LAN connector. This design reduces the number of heating sources inside the sensor unit.

For high accuracy measurements as required for the SLS, some extra equipment is recommended. Because the accuracy of distance measurement mainly depends on the environmental conditions and the stability of the laser wavelength, a Meteo-Station

for registering the environmental conditions and a UPS (Uninterruptible Power Supply) are needed. The UPS keeps the LTD running when the sensor has to be disconnected from the power supply during its movement which guarantees the stability of laser wavelength for further measurements. It is very useful to place the equipment in a wheel cart (Fig.5), which makes it easier to change the location.

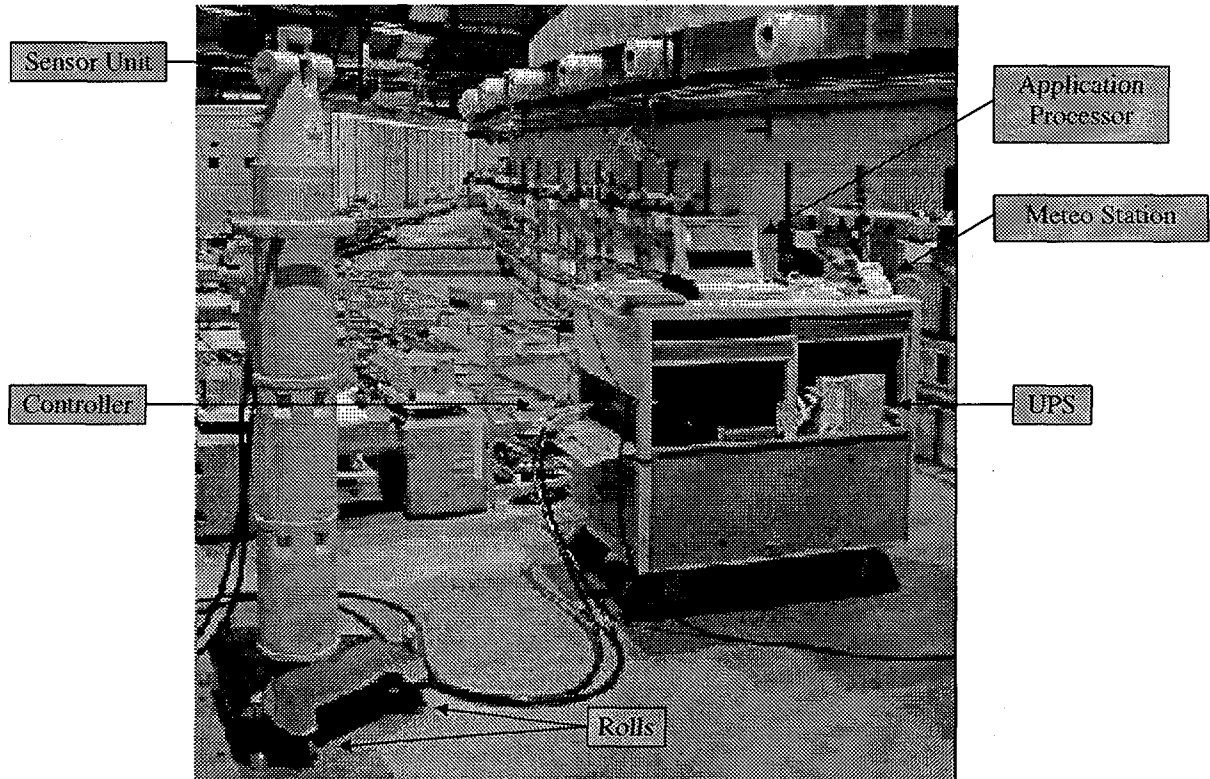

Fig. 5 LTD500 In the SLS tunnel

3.3 Software Components

The frontend to the LTD500 is the Windows based Axyz-Software developed by Leica. The Data Manager Module provides data-handling and calculation routines for the coordinates, while the Laser Tracker Module integrates the communication part for the Laser tracker. In combination with an Environmental Monitor for registering the environmental conditions the Axyz-Software is an easy to use Measurement-System.

A great advantage is, that Axyz delivers basic statistics and real time coordinates of the reflector position, which is very convenient for network measurement and alignment of the accelerator components for the SLS (Fig. 6).

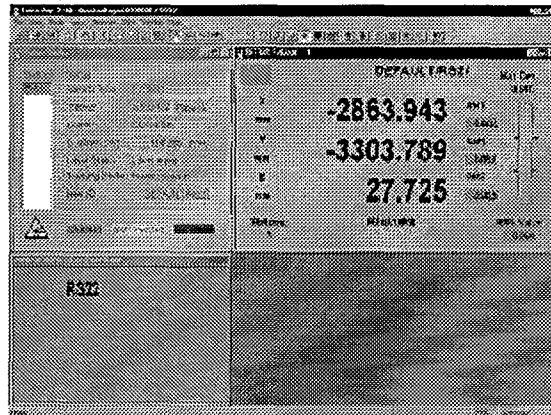
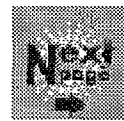
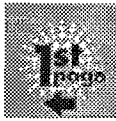

Fig.6 Window for stationary Measurement including basic statistics (e.g. 500 Measurements during 5 sec.)

3.4 Accuracy of the Laser Tracker LTD500

The major factor that influences the accuracy of the LTD500 system is the accuracy of the angle measurement. The angular resolution is 0.14 arc sec. By averaging the measurements to a static target the influence of fluctuations in the atmosphere can be reduced. By averaging more than 100 measurements over at least 5 seconds, an accuracy of ± 10 ppm can be achieved.

The interferometer's resolution is 1.26 microns. The distance accuracy depends mainly on the accuracy of the measurements of air temperature and air pressure. If the temperature can be measured approximately to an accuracy of ± 1 °C and the pressure to an accuracy of ± 4 mbar, a relative distance accuracy of ± 2.5 ppm can be assumed. The absolute distance accuracy, if measured with the interferometer, is also influenced by the determination of the initial distance. In most cases the sensor unit's bird bath will be used for this purpose.

3.5 Calibration and Field check of the Laser Tracker

Calibration of the Laser Tracker is one of the most important processes to achieve highest possible accuracy. A full calibration, which leads to corrections of the calibration data is performed once a year to determine all 15 tracker alignment parameters. The calibration of the home point (bird bath) distance will be made more frequently. For one part of the calibration an invar ball bar is used (Fig. 7).

Intermediate field checks will be done every months or when general working environmental conditions has changed, to check the 3 most important calibration parameters. The field check should be done at the working place under the actual environmental conditions. Laboratories give better results but do not reflect the real world.

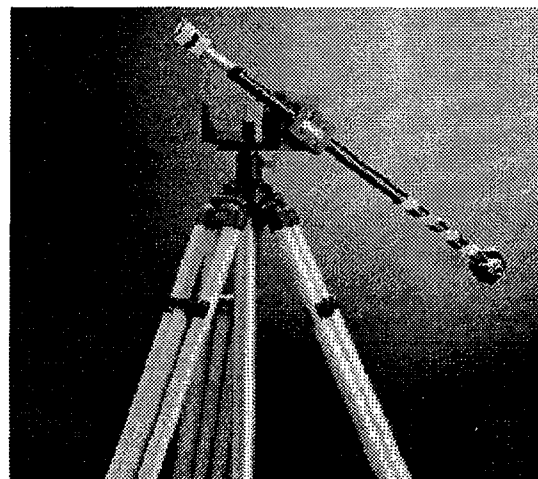

Fig. 7 Mount ball bar



3.6 Reflector

The accuracy of the reflectors, which are used for the measurements, is another important contribution to the overall accuracy of the measurements. The centre accuracy of Leica reflector optics (Fig. 4) is better than ± 0.01 mm. The ball shape error is less than 0.01 mm. There is a difference of a few microns of the home point distance between the different Leica reflectors. Therefore only one reflector, which has been calibrated, will be used. The reflector is always placed in the same orientation into the bird bath and the points to be measured. In this way the influence of optic centre error and ball shape error can be reduced.

3.7 Referencing to gravity

There is no requirement for the LTD500 to be levelled. A network can be referenced to gravity in a number of ways. The following two ways are used in our project:

- ★ Use of control points to gravity in a levelled coordinate system (11 Datum Points)
- ★ Precision leveling

4. First results of the tunnel network

A precision levelling N3 was used to measure the elevations of the tunnel network in May 1999. All differences in height between two adjacent references were measured. At the same time the network was measured with the LTD500 and its software Axyz. The measurements were performed in 53 stations nearby each floor reference. At least two floor references and two wall references of each side, forward and backward were measured as shown in figure 10 and figure 11. At that time the shielding wall was not completed. Civil engineering work was going on nearby. 12 wall references were missing. Because of the poor environmental conditions the standard deviation of the first measurements was 0.24 mm.

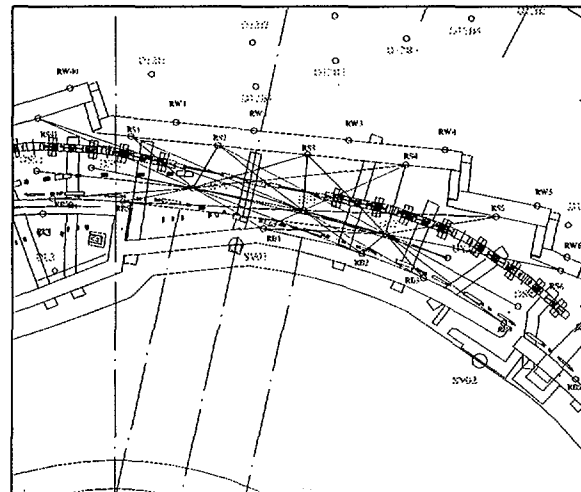

Fig. 10. LTD500 measurement in tunnel

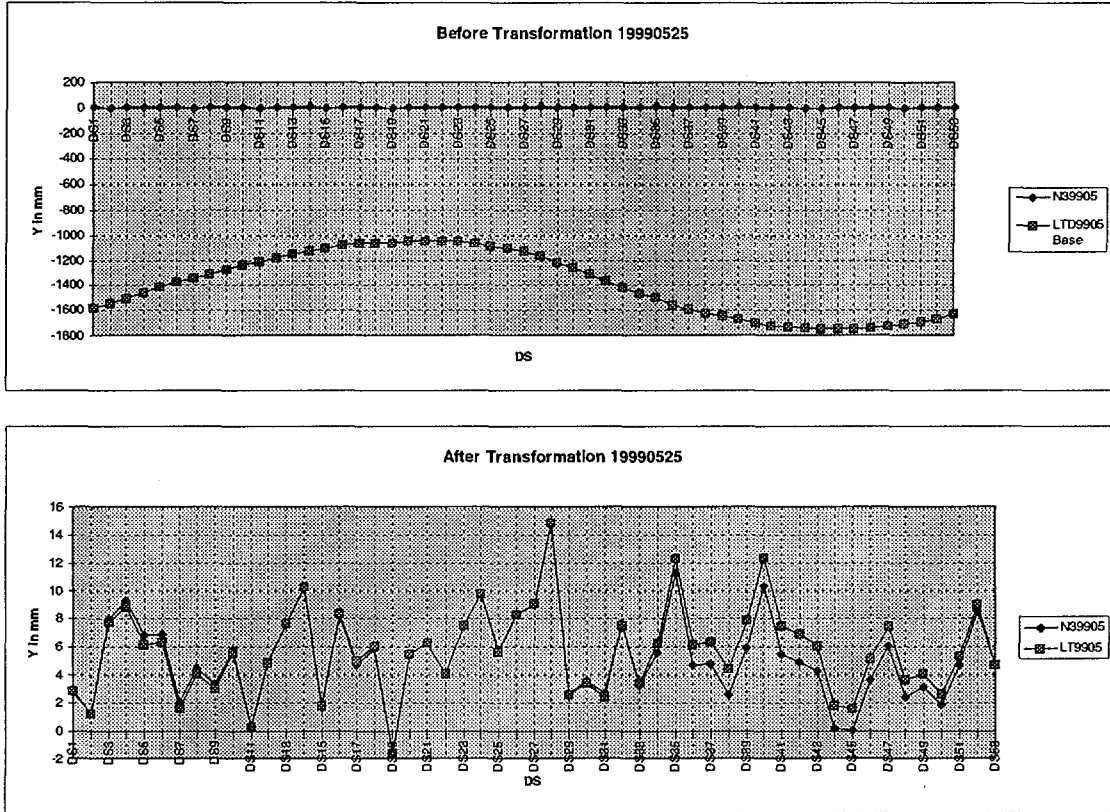
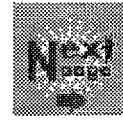

Fig. 11. Heights of Floor References before and after transformation in May 1999

Using bundle adjustment orientation function of the Axyz software the network coordinates can be calculated. This relative coordinates are related to the coordinate system of the LTD500 at the first station without relation to gravity. The levelling data were calculated by software Star*net . The calculation results were imported to the LTD500 Axyz reference file. Using the 3D transformation function of Axyz the relative coordinate system is transformed onto the coordinate system defined by the levelling measurements (shown in figure 11).

In July 1999 the tunnel shielding wall was completed. All 102 wall references were fixed. The tunnel network was measured again by use of the LTD500. The standard deviation of the second measurements was 0.13 mm . This is strongly improved compared to the first measurements because of the improved environmental conditions. The results of the floor references vertical coordinate are shown in figure12.

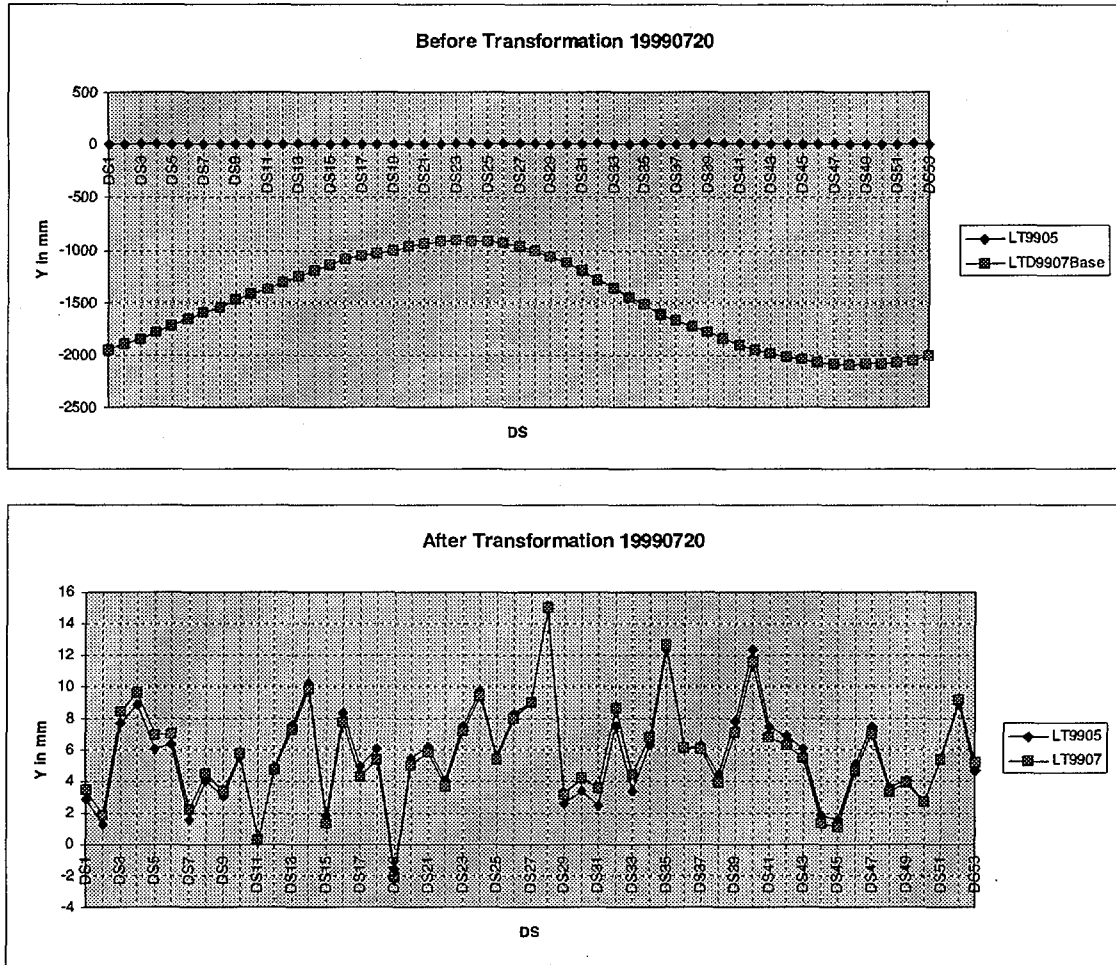

Fig 12. Heights of Floor reference before and after transformation in July 1999

6. Alignment of the Storage Ring

6.1 Support of the storage ring

The SLS storage ring consists of 48 girders. Each girder is supported by 4 pedestals sitting on concrete piers. All the quadrupoles, sextupoles, corrector magnets and BPMs are well fixed on the girder using forced centre mounting systems. All components have a machined mechanical reference surface. The dipole magnets are supported at each end by their two adjacent girders. 3 dipoles link 4 girders as a train link. Each girder can be moved in vertical

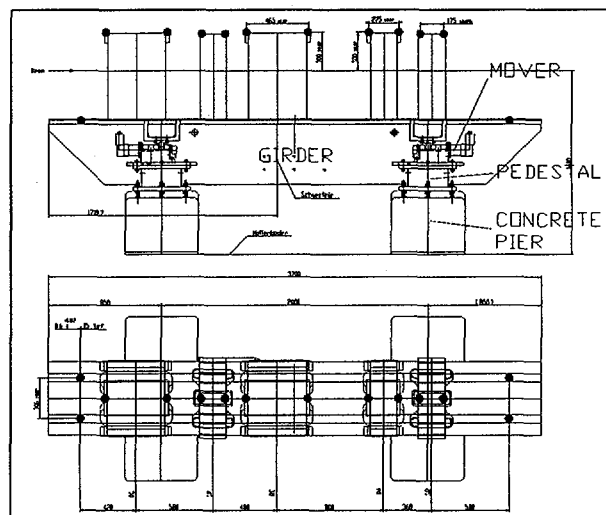
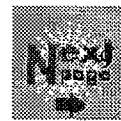
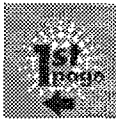

Fig. 13 Support of the storage ring



and horizontal directions within a ± 3.5 mm range by 5 DC motors. The minimal step width of the mover is about $2 \mu\text{m}$. There are 3 M20 screws between the concrete pier and the pedestal for adjustment in the vertical direction within a range of ± 15 mm. And plates between mover and pedestal for adjustment in the horizontal direction in a range of ± 10 mm (Fig. 13).

6.2 Component references and reflector adapter

Most SLS components use standard reference holes shown in figure 14 and a standard reference adapter shown in figure 4. Each top plate of the pedestal has 3 reference holes. There are 4 reference holes on each girder, 2 reference holes on the top of each quadrupole and sextupole (Fig. 13) and 3 reference holes on the top of each dipole magnet (Fig. 18). The positions of the reference holes have been precisely determined during the magnet field measurement.

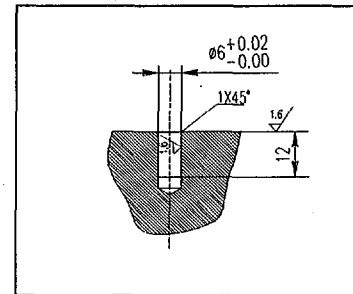

Fig. 14 Reference hole

6.3 First phase of alignment of the storage ring

All the concrete piers were positioned with an accuracy of ± 5 mm during the civil engineering construction. The pedestals will be aligned to their positions with an accuracy of 0.2 mm using the LTD500 and software Axyz. The build function of the software Axyz in LTD 500 (Fig.15 and 16) improves the alignment job dramatically with regard to accuracy and manpower.

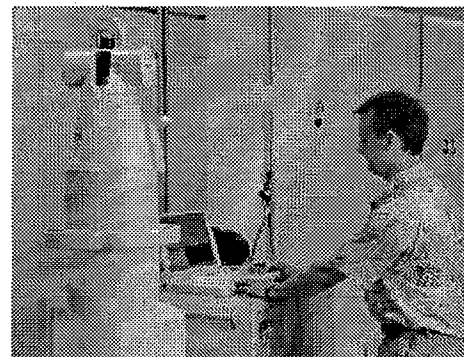

Fig.15 Alignment with LTD500

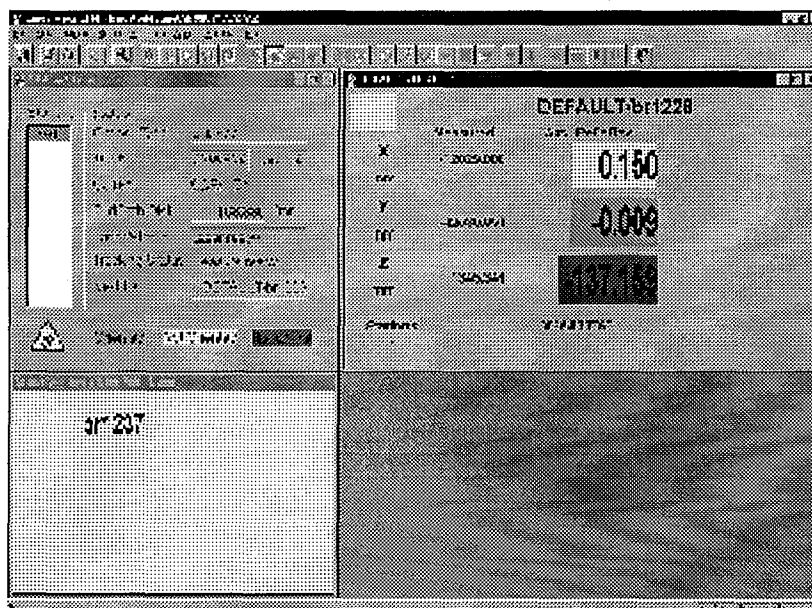
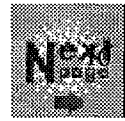

Fig.16 Window for Adjustment delivers real time coordinates and deviations to the reference position.



The dipole magnet will be mounted and aligned on the girders. All the coordinates of the reference holes on girders and magnets will be measured by LTD500 and the best fit results are exported to the control system. The girder itself will be moved by 5 motors in both transverse directions. The tunnel network and positions of all the magnet references will be measured and the girders will be adjusted to their final positions before commissioning of the storage ring.

6.4 Position monitoring system

Each girder is equipped with 4 sets of hydrostatic levelling system (HLS). In addition there is a horizontal position system (HPS) under each dipole magnet to measure the horizontal differential position of the two adjacent girders as shown in figure 17.

All the zero points of the position monitors can be set after the girders are brought to their final positions.

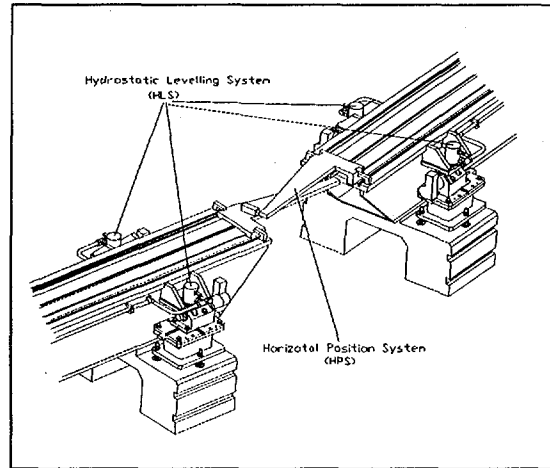

Fig. 17 HLS and HPS

6.5 Second phase of the alignment of the storage ring

During commissioning of the storage ring the girder motors will move each girder into the best position. The position monitoring systems will register those best positions of the girders. All references of the storage ring magnets will be measured to get their final coordinates.

6.6 Error budget

Our main alignment goal is that the relative transverse directions of the storage ring's magnet components reaches a standard deviation better than 100 μm . The items, which are involved, were designed according to following values:

the magnet centre to the girder groove	$\sigma_1 = 30 \mu\text{m}$
the girder groove to the girder reference	$\sigma_2 = 30 \mu\text{m}$
the girder reference to the tunnel network	$\sigma_3 = 25 \mu\text{m}$
the tunnel network locally	$\sigma_4 = 80 \mu\text{m}$

$$\sigma_{Total} = \sqrt{\sigma_1^2 + \sigma_2^2 + \sigma_3^2 + \sigma_4^2} = 94 \mu\text{m}$$

Recently during positioning the supports of the booster and the storage ring the tunnel network was locally measured at more than 30 stations in the last two months. The value was from $\sigma_4=60 \mu\text{m}$ to $110 \mu\text{m}$. We believe that the final value of the tunnel network locally $\sigma_4=80 \mu\text{m}$ will be reached after tunnel is closed completely.

7. Alignment of the Booster

The booster is located in the same tunnel as the storage ring. Most of the magnet components are supported by brackets as shown in figure 18. The brackets are fixed on the concrete wall which was carefully erected into its position mostly within ± 15 mm in the horizontal plane. A plate can be adjusted about ± 25 mm in the horizontal plane. There are 3 screws which support a frame. The frame holds the magnet with 6 screws which allow to adjust the magnet in the horizontal plane. There are 3 reference holes on the top of the magnet.

Though the accuracy of the booster magnet positions is not as high as the accuracy of the storage ring magnets, the same alignment instrumentation LTD500 will be used. Up to now all the frame of the dipole supports are aligned into their positions with a standard deviation of 0.2 mm.

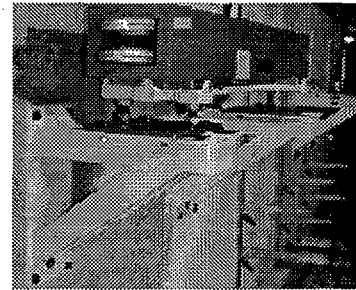
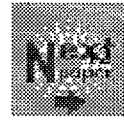

Fig.18 The booster support

8. Alignment of the beam lines

The experimental network was measured in July 1999 using the total station TDA5005. The standard deviation of the measurements was about 0.4 mm. Some additional references of the individual beam line will be added after the detailed designs of each beam line and hutch are made. Most components of the beam lines such as frontends, monochromatrors, mirror boxes, slits and experiment stations have had several reference holes. They can be used for positioning the components with an accuracy of 0.5 mm in respect to the storage ring position. The final alignment will be realised by a simulation laser beam and the synchrotron radiation beam itself.



9. Acknowledgement

The authors would like to thank several colleagues from the mechanic group, the control group and the diagnostic group of the SLS project for their co-operation. We also wish to thank T.Biedermann, now at 'Neugummierungswerk, Pneu Ecker' and many colleagues from 'Bereich Grossforschungsanlagen' of PSI for their participation in the initial survey during the civil engineering construction. We are grateful to R.Ruland from SLAC who diligently proposed the self aligning girder system and contributed to the realization of the hydrostatic levelling system. Our thanks also goes to Prof. W.Schwarz for his comments on the SLS alignment concept.

10. References:

[1] A Synchrotron Light Source for Switzerland, SLS Project, Paul Scherrer Institut, Villigen