

ISSN 0029-3865

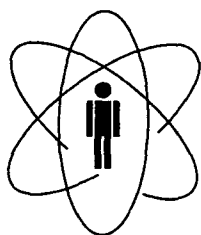

BR0342480



CBPF - CENTRO BRASILEIRO DE PESQUISAS FÍSICAS

Rio de Janeiro

Notas de Física

CBPF-NF-009/01

February 2001

**Graphical Linking of MO Multicenter Bond Index and VB
Structures. II- 5-c Rings and 6-c Heterocyclic Rings**

Carlos Guido Bollini, Mario Giambiagi, Myriam Segre de Giambiagi
and Aloysio Paiva de Figueiredo



CNPq - Conselho Nacional de Desenvolvimento Científico e Tecnológico

Graphical Linking of MO Multicenter Bond Index and VB Structures. II- 5-c Rings and 6-c Heterocyclic Rings

Carlos Guido Bollini^{1,2}, Mario Giambiagi³, Myriam Segre de Giambiagi^{3,4},
and Aloysio Paiva de Figueiredo³

Suggested running head: MO Multicenter Bond Index and VB Structures.

¹Facultad de Ciencias Exactas, Univ. de La Plata, Depto. De Física, C. C. 67, La Plata, Argentina.

²Comisión de Investigaciones de la Pcia. De Buenos Aires, La Plata, Argentina.

³Centro Brasileiro de Pesquisas Físicas, Rua Dr. Xavier Sigaud 150, 22290-180 Rio de Janeiro, RJ, Brasil.

⁴corresponding author: fax (5521) 586 7400; e-mail rio@cbpf.br

Abstract

Through the graphical method proposed, it is possible to set a link between an MO multicenter bond index and VB structures. The value of the index depends on the order of the atoms involved if they are more than three. For 5-c rings, three basic structures are required; the eventually different values are 12. Unlike the 6-c case, it may happen that different pairs of basic structures are used to build the same polygon. For the 6-c rings including heteroatoms, the original degeneracy of benzene splits, leading eventually to 60 different I_{ring} values.

Key Words: MO multicenter bond index; VB structures; 5-c rings; 6-c heterocyclic rings.

INTRODUCTION

Molecular orbital (MO) theory has dealt with chemical bonds since Hückel, who already recognized the possibility of multicenter bonds such as that of the allyl cation [1]. The valence bond methods initially enjoyed more popularity among chemists than MO models, the classical VB structures seeming closer to chemical intuition. Both viewpoints are now seen as complementary, rather than opposed to each other [2].

Several years ago, we proposed a generalization of the Wiberg index [3] to non-orthogonal basis [4], extended later so as to take into account multicenter bonds [5]. We have applied multicenter bond indices to different questions as, for example, the estimation of aromaticity [6]. Multicenter bonds have of course drawn the attention of many authors. Let us mention, among them, the treatment of increased valence structures extensively used by Harcourt [7] and the geminal expansion of pair densities [8].

Our multicenter index $I_{ABC\dots L}$ depends on the $AB\dots L$ order [9], except for the 3-c (three-center) case. In a previous paper we have proposed an interpretation of these different possible values for benzene, linking graphically the MO multicenter index to VBS in a very appealing fashion [10].

The 5c ring with 6π electrons poses quite different questions concerning VBS. This is the main subject of the present work. We also study the 6-c rings including heteroatoms; the lower symmetry compared with that of benzene leads to the splitting of degeneracy into several values.

THE GRAPHICAL METHOD

Let us briefly remind the definitions required. For an N -electron molecule and closed shells, the MO multicenter bond index $I_{ABC\dots L}$ is defined as [5]

$$I_{ABC\dots L} = 2^L \sum_{a \in A, b \in B, \dots, \ell \in L} \Pi_a^b \Pi_b^c \dots \Pi_\ell^a \quad (1)$$

where

$$\Pi_a^b = \sum_i x_{ia} x^{ib} \quad ; \quad N = 2Tr(\Pi) \quad (2)$$

and $x_{ia}(x^{ib})$ are the covariant (contravariant) coefficients of the i -th occupied MO.

For a usual bond (2c), I_{AB} is the generalization of the Wiberg index [3] to non-orthogonal basis [4]. The Π matrix consists of sub-matrices such as Π_{AB} for any pair of atoms, so that Eq.(1) may also be written as

$$I_{AB\dots L} = 2^L Tr(\Pi_{AB}\Pi_{BC}\dots\Pi_{LA}) \quad (3)$$

In Part I [10] we have shown how to link the different values arisen from an MO calculation estimating $I_{AB\dots L}$ to classical VB structures, through Rumer-type diagrams [11]. For benzene, used to illustrate the graphical method, the basic structures yielding the involved polygons are both the canonical structures and non-canonical ones.

If the L -center bond is represented by drawing the L centers on a circle, the L -center index is a number corresponding to a closed broken line joining the points $AB\dots LA$ (Fig. 1). A different $AB\dots LA$ order may match with different polygons. A bond is an arrow in a VB structure and a matrix Π_{AB} ; the inverted arrow is the transposed matrix. Thus, an $AB\dots LA$ order is a polygonal path. It is easily seen that any cyclic permutation yields the same value; the anticyclic order, which amounts to transposing Eq. (3), leading to the same trace, gives also the same value. That is, in the drawing, the broken line may start from any of the L points, in cyclic or anticyclic order. Thus, in the illustration of Fig. 1 for benzene,

$$\begin{aligned} I_{145236} &= 2^6 Tr(\Pi_{14}\Pi_{45}\Pi_{52}\Pi_{23}\Pi_{36}\Pi_{61}) = 2^6 Tr(\Pi_{61}\Pi_{14}\Pi_{45}\Pi_{52}\Pi_{23}\Pi_{36}) \\ &= I_{614523} = I_{632541} = 2^6 Tr(\Pi_{63}\Pi_{32}\Pi_{25}\Pi_{54}\Pi_{41}\Pi_{16}) \end{aligned} \quad (4)$$

It is thus enough to calculate $L!/2L=(L-1)!/2$ values, instead of the $L!$ possible permutations. For benzene, the 720 permutations reduce to 60 possible different values; these correspond to 60 geometrical configurations which we have related to valence bond structures (VBS). For 5 centers, the eventually different configurations are $4!/2=12$.

FIVE-CENTER RINGS

We shall deal with a ring involving 5 centers and 6π electrons. If we denote by f the number of first-neighbour linked atoms and by s the second-neighbours, the twelve

configurations may be grouped in four types, as shown in Fig. 2: a) $5f$; b) $3f+2s$; c) $2f+3s$; d) $5s$. We can relate each configuration to a certain VBS; this one may depend on the initial position. We obtain thus a) (1); b) (2) - (6); c) (7) - (11) and d) (12).

We have chosen to define three types of basic structures, shown in Fig. 3: Kekule (K), Dewar (D) and Modified (M), the last one being non-canonical. They lead to the configurations of Fig. 2, as shown in Fig. 4; as we shall see further, the way of doing this is not unequivocal.

The Rumer-like diagrams need to be adapted in the odd case. The branching diagrams for the 5-c case are usually described for 5π electrons [12]; McWeeny uses diagrams with crossed arrows as independent functions, stating that although they are not the most usually adopted, they are perfectly acceptable as basis functions [12]. In order to use the Rumer method when the number of orbitals to be paired is odd, a phantom orbital is also sometimes added and its contribution is subtracted at the end [13, 14]. Or else, one more point is added, the *pole* [11].

For 5 centers and 6π electrons, the MO approach adds the sixth electron to the delocalized electron pool. There is thus no lone electron pair, but rather a higher concentration of electronic density around the most electronegative atom; otherwise, the exceeding electronic density is spread along the ring. The VBS have two bonds and a lone pair. The graphical method which we propose as a link between both viewpoints is halfway between them.

This is done in Fig.4 according to the following convention for the ABCDE order. The polygonal path starts from position 1; atom 1 is linked to two other atoms in the polygon, the second one being the atom with the lowest label. A cyclic permutation, say EABCD, leads to another VBS, both being complementary in the sense that the polygon is obtained superimposing two VBS. The fifth side of the polygon links the dot of the first VBS to the dot of the second one. One certain VBS may appear twice in the possible configurations; this would mean that it contributes to the I_{ring} value in both cases.

In benzene, due to the unique symmetry of the system, each of the twelve polygons could be unequivocally built from two of the basic structures. For 5 centers the polygons are only four, but the way to build them with the adopted convention is not unequivocal.

Thus, it is shown in Fig. 4 that, while

polygonal a) is K+K,

polygonal b) may be obtained either as K+M, D+K or D+D;

polygonal c) in turn is found as M+K, M+D or D+D. Finally,

polygonal d) is M+M.

This pattern is quite different from that, much simpler, of benzene.

We shall limit our discussion to two alternatives: I) the 5 centers are occupied by atoms of the same nature (cyclopentadienyl anion) and II) a "first perturbation" is added, i.e. a heteroatom (pyrrole, furan and thiophene).

Case I

As seen in Table 1, only four values are obtained in this case for the twelve eventually different configurations. The type a) value for the cyclopentadienyl anion is 0.11451. Configurations 2 to 6 of Fig. 2 are here equivalent for, independently of the different VBS which each of them give place to, all the polygons may be superimposed in the same figure by successive 72° rotations around the pentagon center. In group theory terms, symmetry operations bring the broken line polygons into coincidence [15]. We have hence the single value of 0.01654 for type b) configurations.

For the same reasons, we have again 5-fold degeneracy for type c) values ($2f+3s$), i.e. -0.00631 . Finally, type d) ($5s$), as type a), can give only one value.

For this homonuclear case, type a) configuration can only be represented by Kekule VBS with spin alternation. Similarly, only the basic structure M arises for d), without spin alternation. For types b) and c) the three basic structures appear; in type b) only D structures allow spin alternation, while in type c) this applies to the K structure.

Case II

We have drawn in Fig. 5 the twelve configurations corresponding to those in Fig. 2, when a heteroatom is placed at position 1. The degenerate b)- and c)- type configurations split now into three different possible index values in each case, as $II=V$ and $III=IV$.

The different VBS that may arise for each configuration of Fig. 5, depending on the initial ring position, are shown in Fig. 6. The first column starts from position 1, the second from the second position along the polygon path and so on. Thus, the configurations aI, bI, cI and dI are related to five VBS, but $\delta = \gamma$ and $\eta = \theta$. In the ground state, described by aI, these three Kekule-type VBS are precisely those most heavily contributing to the ground state of this kind of molecules. From what precedes, twice the “weight” of ε would be ascribed to δ and η . Similar considerations regarding “weights” may be applied to bI, cI and dI. The VBS for bII (= bV) and bIII (=bIV) may be also obtained straightforwardly. The five different VBS have now the same “weight”; the same thing holds for cII (=cIV) and cIII (=cV).

In the ground state which, as we have just mentioned, is described by aI, the K-type VBS show spin alternation. As we had seen for benzene, and is remarked by other authors [16], the ground state shows a dominant role of spin alternation. In bI, bII and bIII, only D-type VBS show spin alternation, while in cI, cII and cIII it takes place only in K-type structures.

Finally, for d) only crossing VBS appear, with no spin alternation.

We have reported in Table I the 5c- I_{ring} values for all configurations of the molecules mentioned in this section. It is manifest that the discrimination between otherwise degenerate values issues from the loss of symmetry when a heteroatom is introduced in the 5-c ring.

It is easily seen from Eq. (3) that, if there is $\sigma - \pi$ separation, the submatrices being block-diagonal in σ and π , it can be written

$$I = I^\sigma + I^\pi \quad (5)$$

As it happened with benzene, I_{ring} is mainly π also for the 5-c rings. One could wonder if a π calculation would suffice. Yet, we have obtained elsewhere a quite different picture for the highly strained 3c-rings [17], where I_{ring} is mainly σ in nature. Accordingly, the notion of σ aromaticity is applied to such systems [18].

SIX-CENTER HETEROCYCLIC RINGS

We have mentioned that for a 6-c ring we may eventually obtain up to 60 different values for I_{ring} . Due to the highly peculiar symmetry of the system, for benzene they are actually 12 (Fig. 7). In Fig. 7, as in our previous reference [10], the configurations have been ordered according to the number of the involved first-neighbour (*o* for *ortho*), second-neighbour (*m*, *meta*) and third-neighbour (*p*, *para*) linked atoms. As for the pentadienyl anion, for each one of the twelve configurations in benzene, successive 60° rotations around the system center lead to the same diagram, superimposed with the first one.

The introduction of heteroatoms in the benzene hexagon splits the degenerated values from the 12 found for benzene up to 60 values when there is no symmetry. In this work, the examples chosen are the monocyclic azines.

We illustrate in Fig. 8 the behaviour of group c) values, i. e. configurations 8 to 10 of pyridine and of 1,3,6 triazine. As for benzene [10], the VBS corresponding to this polygon are the Dewar ones exhibiting spin alternation and the second highest I_{ring} value. The polygons of configurations 9 and 10 of pyridine may be superimposed by successive 60° rotations; for 1,3,6 triazine this is not possible. Accordingly, the benzene value of 0.02197 becomes 0.02359 for configuration 8 and 0.02073 for configurations 9 and 10 respectively in pyridine. The corresponding values for this asymmetric triazine are respectively 0.02467, 0.02131 and 0.01839. Turning back to pyridine, the weight of VBS (\square) is twice that of VBS ($\#$), as it should.

We have reported in Table II the number of different I_{ring} values for each one of the monocyclic azines corresponding to the different symmetry cases; they are compared to benzene. As symmetry decreases, the number of different values increases up to the 60 different values for 1,3,6 triazine, a molecule belonging to the C_s group.

For 1,3,5 triazine (D_{3h}), there is only one more value than the 12 for benzene; it arises within the d^* configurations (11 to 22). We show it in Fig. 9 i): a 60° rotation of configuration 11 in the counterclockwise direction yields a configuration which cannot be superimposed with the former one.

The molecules belonging to the C_{2v} group exhibit two kinds of cases, depending on

whether the symmetry axis passes or not through two atoms in the molecule. Pyridine and pyrimidine belong to the first kind, pyridazine to the second one. In the first kind the π system has four symmetric and two antisymmetric basis functions, while the second kind of system has three of each. The first has a lower number of different I_{ring} values from the second one; we show an example in Fig. 9 ii). In one d^{**} configuration, a rotation leads to the same diagram in pyrimidine and to a new diagram in pyridazine.

Hence it is possible, through graphical arguments, to predict the number of different I_{ring} values which may appear within the 60 eventual possibilities. The 6-c case affords an appealing illustration of the method.

CONCLUSIONS

- For 5-c rings we are led graphically to four different values for I_{ring} if all the ring atoms are equal and to eight values if the ring includes a heteroatom.
- For 5-c rings it may happen that different pairs of basic structures are used to build the same polygon.
 - The highest I_{ring} value corresponds to Kekule-type structures in VB terms.
 - For 5-center rings, I_{ring} is mainly π .
- For 6-c heterocycles, the graphical method helps to understand and predict the different I_{ring} values arising as symmetry is lowered, starting from benzene (12 values) up to 1,3,6 triazine (60 values).

ACKNOWLEDGEMENT

The authors wish to acknowledge the useful discussions carried out with Prof. Ricardo Bicca de Alencastro.

FIGURE CAPTIONS

Fig. 1 – Representation of a 6-center index for benzene and the corresponding VB structures.

Fig. 2 – Geometrical configurations and VB structures for 5-center rings; *f* means first-neighbour atoms and *s* second-neighbour atoms.

Fig. 3 – Basic structures yielding the configurations of Figure 2.

Fig. 4 – Building the configurations of Fig. 2 from the basic structures of Fig. 3.

Fig. 5 – The configurations for a 5-c ring with a heteroatom in position 1.

Fig. 6 – Possible VBS for each different configuration of Figure 5.

Fig. 7 – Geometrical configurations for 6-center rings; *o* means *ortho*, *m* *meta* and *p* *para* types of neighbours.

Fig. 8 – Splitting of degeneration in configurations c) of Fig. 7, for pyridine and 1,3,6 triazine. For pyridine, configurations 9 and 10 are equivalent, for 1,3,6 triazine they are not. The VBS are shown for pyridine.

Fig. 9 – Examples of different configurations, otherwise degenerate, which arise by lowering the benzene symmetry through the introduction of heteroatoms in the ring. i) 1,3,5 triazine; ii) pyrimidine and pyridazine.

Figure 1

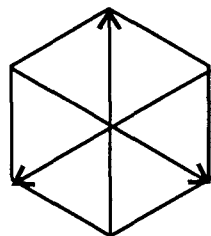
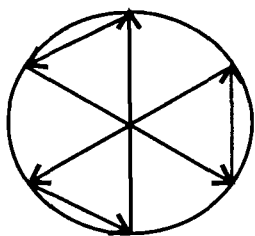

or

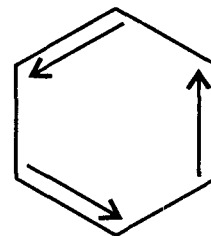

I₁₄₅₂₃₆

Figure 2

a) $5f$

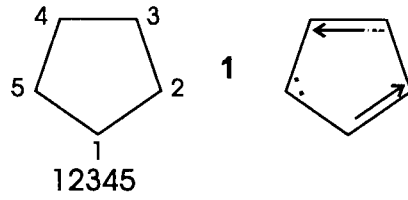

b) $3f + 2s$

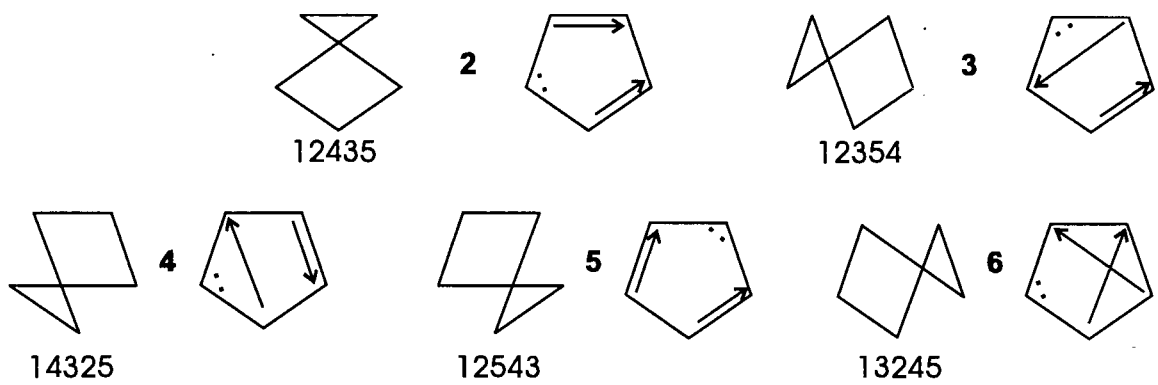

c) $2f + 3s$

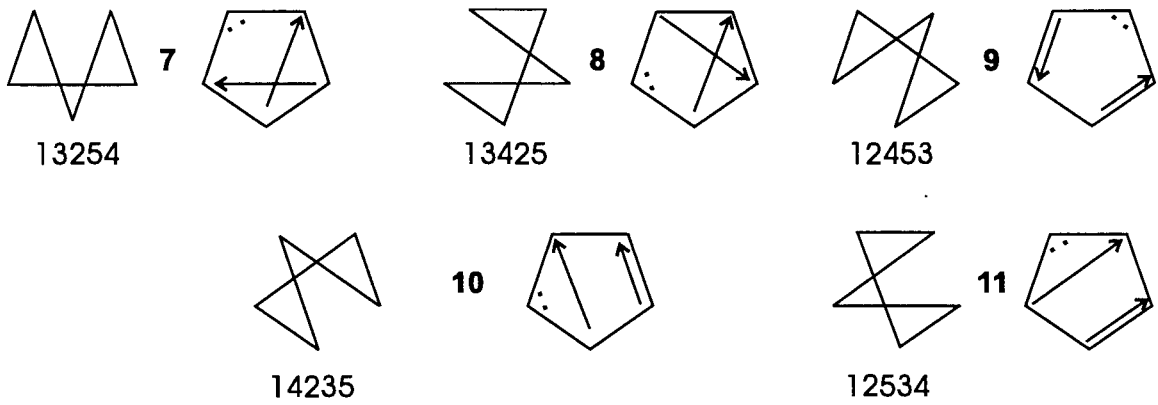

d) $5s$

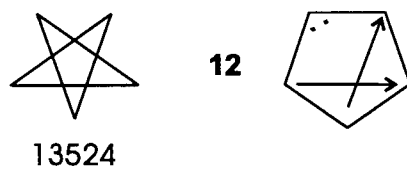
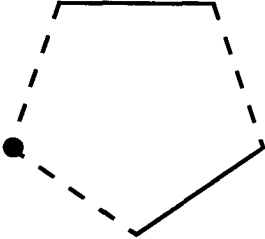
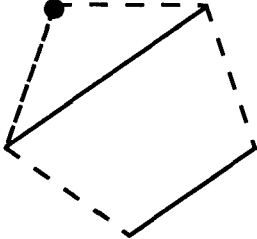

Figure 3



K



D

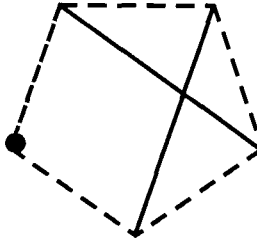

M

Figure 4

a) $5f$

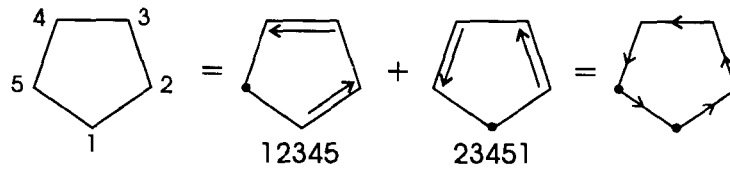

b) $3f + 2s$

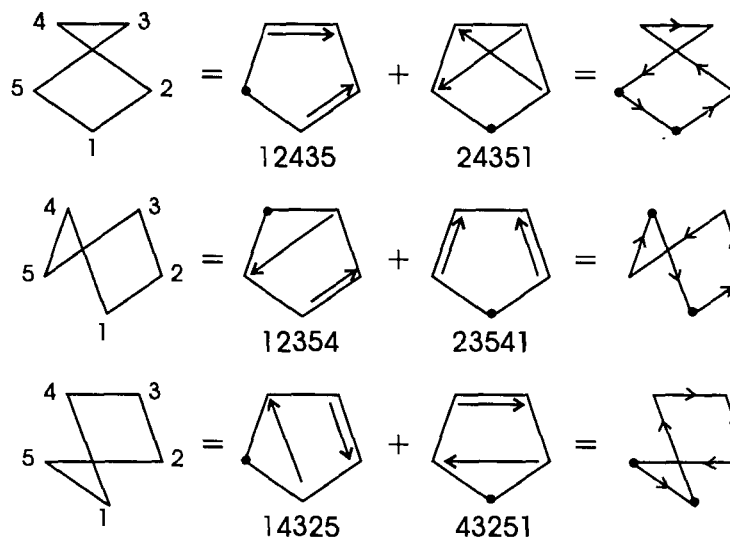

c) $2f + 3s$

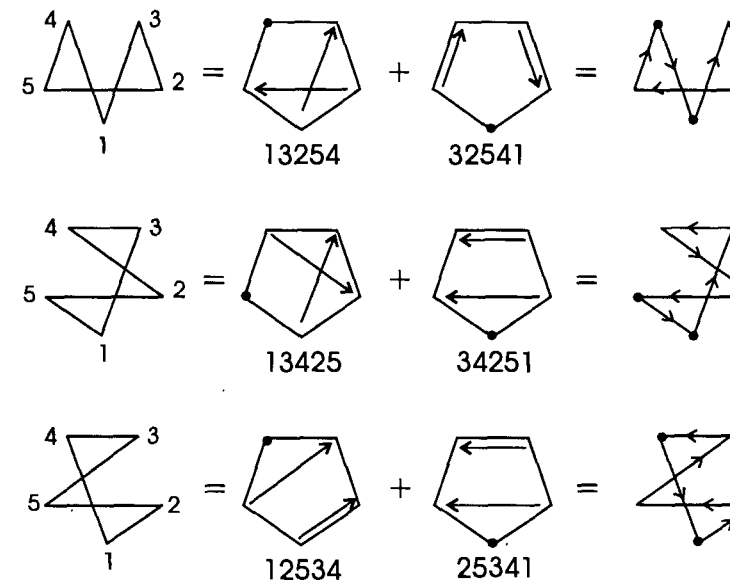

d) $5s$

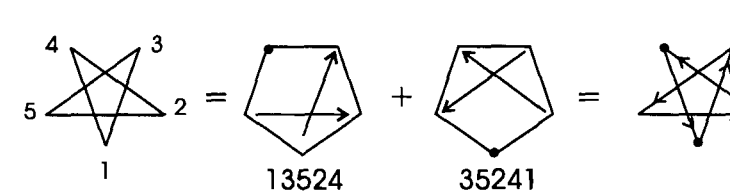

Figure 5

Type	Configurations				
	I	II	III	IV	V
a	 <p>12345</p>				
b	 <p>12435</p>	 <p>12354</p>	 <p>14325</p>	 <p>12543</p>	 <p>13245</p>
c	 <p>13254</p>	 <p>13425</p>	 <p>12453</p>	 <p>14235</p>	 <p>12534</p>
d	 <p>13524</p>				

Figure 6

Type	Conf.	VBS				
		δ	ϵ	γ	η	θ
	a I					
		12345	23454	34512	45123	51234
	b I					
		12435	24351	43512	35124	51243
	b II					
		12354	23541	35412	54123	41235
	b III					
		14325	43251	32514	25143	51432
	c I					
		13254	32541	25413	54132	41325
	c II					
		13425	34251	42513	25134	51342
	c III					
		12453	24531	45312	53124	31245
	d I					
		13524	35241	52413	24135	41352

Figure 7

a) $6o(1)$

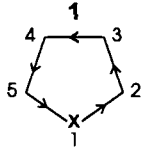
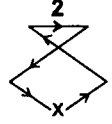
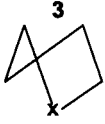
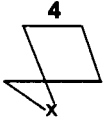
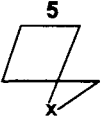
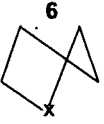
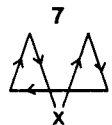
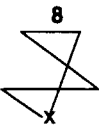
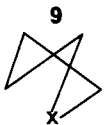
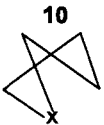
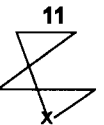
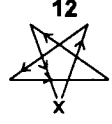
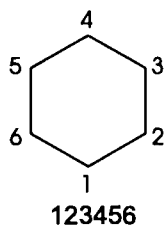

b) $4o + 2m(2-7)$

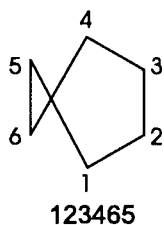

c) $4o + 2p(8-10)$

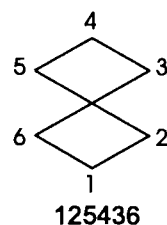

d) $3o + 2m + 1p$

*) (11-22)

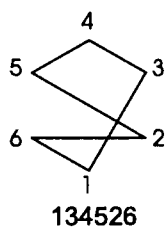

**) (23-28)

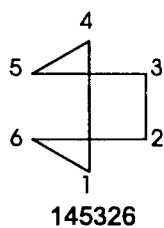

e) $3o + 3p(29-30)$

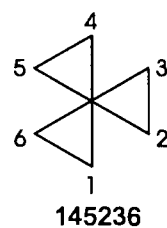

f) $2o + 4p$

*) (31-33)

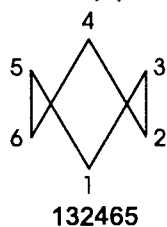

**) (34-39)

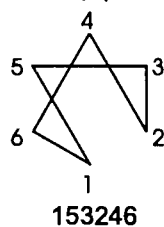

g) $2o + 2m + 2p(40-45)$

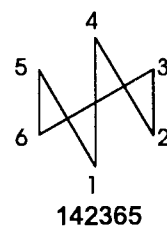

h) $1o + 4m + 1p(46-51)$

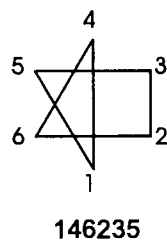

i) $1o + 2m + 3p(52-57)$

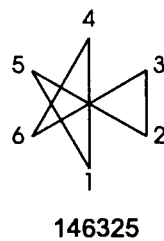

j) $4m + 2p(58-60)$

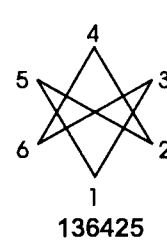

Figure 8

Conf.	Polygon	VBS	Polygon
8			
9			
10			

Figure 9

i)



(d*)

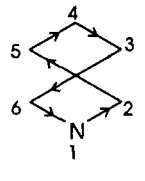
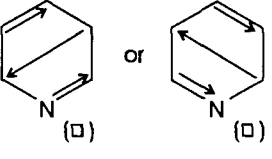
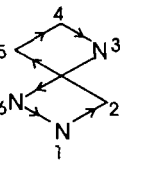
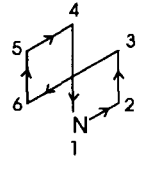
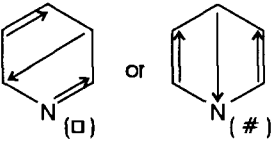
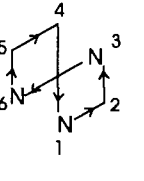
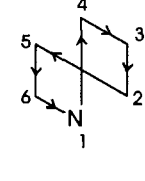
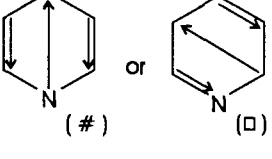
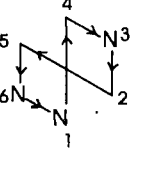
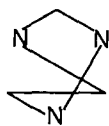

ii)

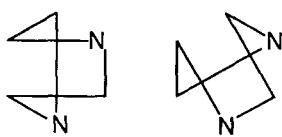

(d**)



Table I - The different I_{ring} values for typical 5-c rings. X=CH cyclopentadienyl anion, X=NH pyrrole, X=O, furan, X=S thiophene. For X=CH all type b and all type c configurations are equivalent; in the other molecules, for b and c II=V and III=IV.



Configuration	Type	I_{ring}			
		X=CH	X=NH	X=O	X=S
	a I	0.11451	0.09618	0.05414	0.06951
	b I	0.01654	0.00234	0.00011	0.00034
	b II		0.00990	0.00495	0.00492
	b III		0.02360	0.01291	0.01846
	c I	-0.00631	-0.01522	-0.01392	-0.01692
	c II		-0.00366	-0.00101	-0.00154
	c III		-0.00161	-0.0044	-0.00038
	d I	-0.00092	-0.00039	-0.00010	-0.00011

Table II - Distribution of the different \mathcal{N} values for benzene and sample monocyclic azines. See Fig .7.

Molecule	Sym.	\mathcal{N}	a	b	c	d*	d**	e	f*	f**	g	h	i	j
 benzene	D_{6h}	12	1	1	1	1	1	1	1	1	1	1	1	1
 1,3,5 triazine	D_{3h}	13	1	1	1	2	1	1	1	1	1	1	1	1
 pyrazine	D_{2h}	24	1	2	2	3	2	1	2	2	3	2	2	2
 pyridine	C_{2v}	32	1	3	2	6	3	1	2	3	3	3	3	2
 pyrimidine	C_{2v}	32	1	3	2	6	3	1	2	3	3	3	3	2
 pyridazine	C_{2v}	38	1	4	2	6	4	2	2	4	3	4	4	2
 1,3,6 triazine	C_s	60	1	6	3	12	6	2	3	6	6	6	6	3

REFERENCES

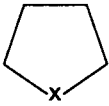
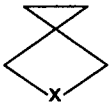
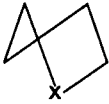
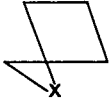
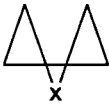
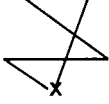
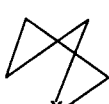
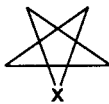
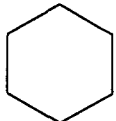
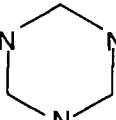
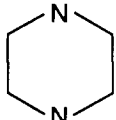
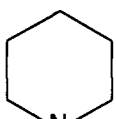
1. De Kock, R. L.; Bosma, W. B. *J. Chem. Educ.* **1988**, *65*, 194 and refs. therein.
2. see for example Hiberty, P.C. *J. Mol. Struct. (Theochem)* **1988**, *451*, 237.
3. Wiberg, K. *Tetrahedron* **1968**, *24*, 11083.
4. Giambiagi, M.; Giambiagi, M. S. de; Gempel, D. R.; Heymann, C. D. *J. Chim. Phys.* **1975**, *72*, 15; Giambiagi, M. S. de; Giambiagi, M.; Jorge, F. E. *Z. Naturforsch.* **1984**, *39 a*, 1259.
5. Giambiagi, M.; Giambiagi, M. S. de; Mundim, K. C. *Struct. Chem.* **1990**, *1*, 423.
6. Giambiagi, M.; Giambiagi, M. S. de; dos Santos Silva, C. D. ; Paiva de Figueiredo, A. *Phys. Chem. Chem. Phys.* **2000**, *2*, 3381.
7. Harcourt, R. D. *J. Mol. Struct. (Theochem)* **1971**, *9*, 221; Harcourt, R. D. In *Pauling's Legacy: Modern Modelling of the Chemical Bond*; Maksic, Z. B.; Orville-Thomas, W. J., Eds.; Elsevier: Amsterdam, 1999 and refs. therein.
8. Ponec, R.; Bochicchio, R. C. *Int. J. Quantum Chem.* **1995**, *54*, 99 ; Ponec, R.; Uhlik, F. *Croat. Chim. Acta* **1996**, *69*, 941.
9. Sannigrahi, A . B. private communication.
10. Bollini, C.G.; Giambiagi, M.; Giambiagi, M. S. de; Paiva de Figueiredo, A. *J. Math. Chem.*, to be published.
11. Pauncz, R. *Spin Eigenfunctions*; Plenum Press: N. York, 1979; chap. 5.
12. see for example Mc Weeny, R. *Methods of molecular quantum mechanics*; Academic Press: London, 2nd ed., 1989; pp. 94 and 102.
13. Pauling, L. J. *Chem. Phys.* **1933**, *1*, 280.
14. Levine, I. N. *Quantum chemistry*; Prentice Hall: Englewood Cliffs; 4th ed, 1991; p. 527.

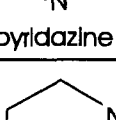
15. Mc Weeny, R. *Symmetry – An Introduction to Group Theory and Its Applications; (The International Encyclopedia of Physical Chemistry and Chemical Physics - Vol. 3)*; Pergamon Press: Oxford, 1963; chap. 1.
16. Maynau, D.; Malrieu, J.-P. *J. Am. Chem. Soc.* **1982**, *104*, 3029.
17. Giambiagi, M. S. de; Giambiagi, M.; Paiva de Figueiredo, A ., to be published.
18. see for example Dewar, M. J. S. *J. Am. Chem. Soc.* **1984**, *106*, 669 and refs. therein; Cremer, D. *Tetrahedron* **1988**, *44*, 7421.

NOTAS DE FÍSICA é uma pré-publicação de trabalho original em Física.
Pedidos de cópias desta publicação devem ser enviados aos autores ou ao:

Centro Brasileiro de Pesquisas Físicas
Área de Publicações
Rua Dr. Xavier Sigaud, 150 – 4^o andar
22290-180 – Rio de Janeiro, RJ
Brasil
E-mail: socorro@cbpf.br/valeria@cbpf.br

NOTAS DE FÍSICA is a preprint of original unpublished works in Physics.
Requests for copies of these reports should be addressed to:

Centro Brasileiro de Pesquisas Físicas
Área de Publicações
Rua Dr. Xavier Sigaud, 150 – 4^o andar
22290-180 – Rio de Janeiro, RJ
Brazil
E-mail: socorro@cbpf.br/valeria@cbpf.br