

High Beta Plasma Confinement and Neoclassical Effects in a Small Aspect Ratio Reversed Field Pinch

K. Hayase 1), H. Sugimoto 1), H. Ashida 1), Y. Sato 1), Yagi 1), Y. Hirano 1), T. Shimada 1), H. Sakakita 1), H. Koguchi 1), Y. Nagamine 2), Y. Yoshioka 2), M. Harada 2), Y. Osanai 2), K. H. Saito 2), K. N. Saito 2), S. Shiina 2), M. Taguchi 3), Y. Kondoh 4), E. Uchimoto 5)

1) National Institute of Advanced Industrial Science and Technology, Tsukuba, Japan

2) College of Science and Technology, Nihon University, Tokyo, Japan

3) College of Industrial Technology, Nihon University, Chiba, Japan

4) Faculty of Engineering, Gunma University, Kiryu, Japan

5) Department of Physics and Astronomy, University of Montana, MO, USA

e-mail contact of main author: k.hayase@aist.go.jp

Abstract. The high β equilibrium and stability of a reversed field pinch (RFP) configuration with a small aspect ratio are theoretically studied. The equilibrium profile, high beta limit and the bootstrap current effect on those are calculated. The Mercier stable critical β decreases with $1/A$, but $\beta \sim 0.2$ is permissible at $A=2$ with help of edge current profile modification. The effect of bootstrap current is evaluated for various pressure and current profiles and cross-sectional shapes of plasma by a self-consistent neoclassical PRSM equilibrium formulation. The high bootstrap current fraction (F_{bs}) increases the shear stabilization effect in the core region, which enhances significantly the stability β limit compared with that for the classical equilibrium. These features of small aspect ratio RFP, high β and high F_{bs} , and a possibly easier access to the quasi-single helicity state beside the intrinsic compact structure are attractive for the feasible economical RFP reactor concept.

1. Introduction

The reversed field pinch (RFP) is one of technically simplest and most economical reactor concepts. Many efforts have been devoted for its further improvement, and new concepts are recently developed. A quasi-single helicity state has an excellent confinement property [1, 2]. The number of resonant mode is smaller in the core plasma region at a smaller aspect ratio, and then a plasma could be less stochastic [3]. The critical β may be enhanced to a great extent by an edge current modification [4]. A consideration of neoclassical effect in the MHD equilibrium has led to a significant fraction of bootstrap current in a small aspect ratio, which is quite important to a steady state operation as well as to a high β stability [5].

The paper is composed of two parts. In the first part, the characteristic equilibrium plasma profile and its Mercier stability [6] are calculated in a small aspect ratio region. The critical β is shown as functions of aspect ratio (A) and cross-sectional shape (circular and vertically elliptic), and its improvement is shown possible by the control of edge current profile. The design and experimental plan of a device with $A \sim 2$ are described based on these calculations. In the second part, neoclassical effects on the equilibrium and stability are investigated. In evaluating the bootstrap current (BSC) effect, the self-consistent neoclassical MHD equilibrium equation [7] is solved in the partially relaxed state (PRSM [8]) RFP configuration. The BSC profile and its effect on the magnetic shear are calculated and discussed for various current and pressure profiles and cross-sectional shapes of plasma.

2. High Beta Stability and Device Design

2.1. General Equilibrium Profile and Beta Scaling

Here the equilibrium profile and Mercier stability of the plasma with a small aspect ratio are

studied. The equilibrium profile (q , B , j) and critical β are calculated as functions of aspect ratio, cross-sectional shape (circular and vertically elliptic). In solving the Grad-Shafranov equation, the pressure and current functions, $p(\Psi)$ and $I(\Psi)$, are chosen as $p(\Psi)=\lambda_1\alpha/2\{1-\exp[2(\Psi-\Psi_a)/\xi]\}$ and $I(\Psi)=\lambda_1\Psi+\alpha\alpha_2\exp[(\Psi-\Psi_a)/\xi]$ respectively, where Ψ_a is the Ψ value on the shell/wall surface, ξ the plasma pressure profile parameter, α the plasma pressure parameter, and α_2 , the pressure effect parameter on the toroidal magnetic field. Under the constraint of fixed boundary RFP configuration, the stability is analyzed numerically against the ideal MHD localized mode. The Mercier criterion may not be appropriate to apply to the lowest mode in the extremely small A case, but it could be applied approximately to the high β analysis at $A\sim 2$, which is of our interest, as an necessary condition of stability.

The most important issues in a small A region are the features of q profile and critical β . The q profile determines the stability and mode dynamics. The general characteristics of q profile are found as follows; q increases on the axis and sharply decreases at the edge as A decreases. $q(0)$ and $q(a)$ are shown for the circular cross-section in Fig. 1. The profile flattens in the core region as A decreases. The tendency is remarkable at A less than 1.5. So that the number of resonant surfaces (at $q=m/n$, where m is the poloidal mode number and n is the toroidal mode number) decreases, and also n decreases, *i. e.*, locations of resonant tearing mode separate more from each other. The minimum n , assuming $m=1$ is dominant, is 3 or 4 at $1.2<A<2.1$ or $2.1<A<2.8$, respectively. These features of q profile may give a strong effect on the dynamo process in RFPs. The fluttering of q profile in a small A region is more remarkable in the elongated cross-section.

In Fig. 2, the critical poloidal beta β_p is plotted for $\kappa=1$ and 1.5 (κ ; vertically elongation factor or ellipticity) as a function of A . β_p decreases with decrease of A ; $\beta_p=0.035$ and 0.07 at $A=1.5$ and 2, respectively, at $\kappa=1$. As qA is approximately constant in RFP, the volume-averaged total beta β is proportional to β_p ; $\beta=0.02$ and 0.04, at $A=1.5$ and 2, respectively. Both β_p and β are proportional to $A^{0.9-1.1}$ in $A<4$. The ellipticity seems to improve β_p and β at $A<3.5$, unlike [9]. These β -scaling features are quite different from tokamak. To improve the β limit at a small A , the plasma current profile is modified; the enhanced current density at the edge region, *i. e.*, λ ($=B/j$) is slightly enhanced at the edge region. This leads to a substantial increase of β . At $\kappa=1$, β is enhanced sharply by a small increase of edge current density (j^0 ; edge current density parameter), however, at $\kappa=2$ it is enhanced gradually with j^0 . The β enhancement factor is $3\sim 4$ and it is more intensive at a smaller A (Fig. 3).

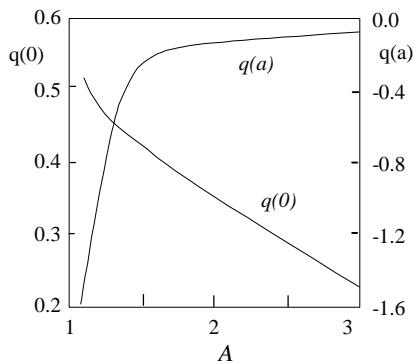

FIG. 1. On-axis $q(0)$ and surface $q(a)$ vs. A .

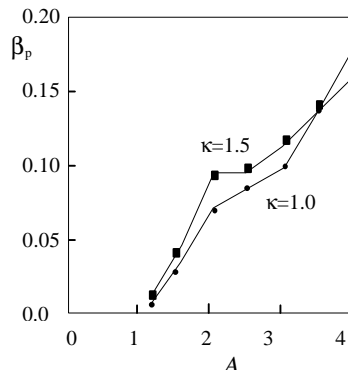

FIG. 2. Critical β_p vs. A .

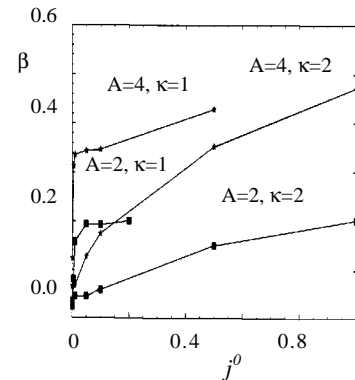

FIG. 3. β improvement by enhanced edge current.

2.2. Experimental Plan of Small Aspect Ratio RFP

An experiment is newly planned for a small aspect ratio RFP. The minimum A is usually limited by a large necessary poloidal flux (a high loop voltage in RFP); $A_{\min} \sim 2$ at $a \sim 0.2$ m [10]. The minimum n is deduced from the q profile as a function of A and it is shown in Fig. 4. At $A \sim 2.1$, the minimum n can be 3 or 4 by control of the axis shift. Fig. 5 illustrates the designed device by modification of the old device. The dynamo-mode dynamics, critical β and bootstrap current generation will be tested.

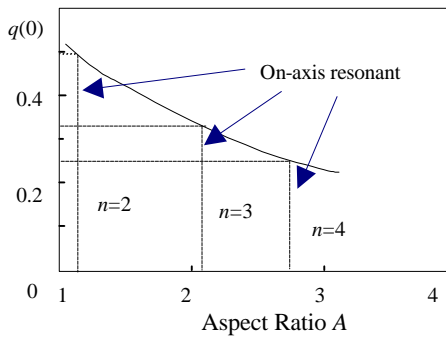

Fig. 4. A vs. $q(0)$. The on-axis resonance appears at the definite A .

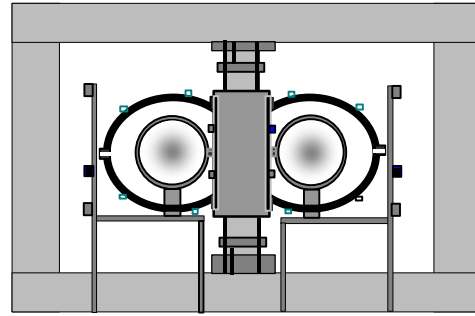

Fig.5. A newly designed small aspect ratio RFP device at AIST. $R/a=0.52\text{m}/0.25\text{m}$.

3. Neoclassical Effect in RFP Equilibrium

The localized mode stability and neoclassical effect on the RFP equilibrium are also evaluated in the partially relaxed state model (PRSM) [8] with uniform j_p/B_p profile. The dependences of the equilibrium and stability properties, and BSC profile on the plasma pressure profile, β and cross-sectional shape are investigated. The neoclassical MHD RFP equilibrium including BSC effects is calculated self-consistently and compared with the classical MHD equilibrium.

3.1. Stability of Classical MHD Equilibrium

In the small aspect ratio RFP equilibrium, the pressure profile control is particularly necessary so that the stability condition for pressure-driven high n localized modes can be satisfied (Mercier's criterion [6]) while keeping a high bootstrap current ratio $F_{\text{bs}} \equiv I_{\phi}^{\text{bs}}/I_{\phi}^{\text{eq}}$ (I_{ϕ}^{bs} : total toroidal BSC, I_{ϕ}^{eq} : plasma current). The Mercier criterion expressed as $D_M - 1/4 < 0$ is evaluated as function of the flux surface, by use of the numerical solution to the equilibrium equation, such as in section 2. BSC is calculated by use of Hirshman model [11], which is the single ion model in the collisionless limit and valid for an arbitrary aspect ratio and flux surface geometry. The pressure profile is taken to be of the form; $p(\psi) = p_0(1 - \Psi^{\text{bp}})^{\text{ap}}$, where Ψ is the normalized poloidal flux and p_0 the pressure at the magnetic axis. The geometry of plasma boundary is assumed to be fixed and its non-circularity is expressed by both ellipticity κ and triangularity δ .

The result of equilibrium and local stability calculations for various pressure profiles are summarized in Fig. 6. The q -profiles, Mercier coefficients ($D_M - 1/4$) and BSC profiles of PRSM-RFP configuration with $A=2.0$, $p_0=8.4$ kPa, $\kappa=1.4$ and $\delta=0.4$ are illustrated. The figure shows that the equilibria having peaked pressure profiles, for example, $(a_p, b_p)=(2.0, 1.0)$, *i. e.*, parabolic profile and $(1.4, 1.0)$ in this case, are unstable in the central region. The parabolic pressure profile is close to the Suydam-mode stable one in the cylindrical geometry and also

preferable from the viewpoint of decreasing the average temperature required to generate the maximum fusion thermal power and to attain the ignition condition for a given density profile [12]. Therefore, a pressure profile, which is close to parabolic and satisfies the Mercier criterion, should be chosen by its profile control. The Mercier criterion can be satisfied by a broad profile with a relatively high β value, *e. g.*, $\beta_t=0.61$ in $(a_p, b_p)=(1.0, 3.0)$. It is noted that the Mercier criterion can be satisfied even for a relatively peaked pressure profile ($a_p=1.4$, $b_p=1.0$) by increasing κ (up to ~ 2) and δ of plasma cross-section.

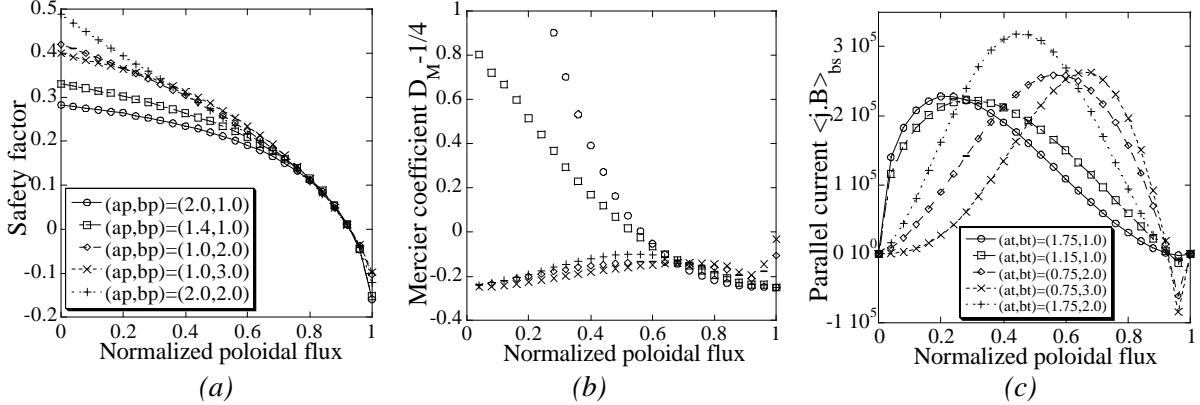

FIG. 6. PRSM-RFP equilibrium profiles for each pressure profile. (a) q -profile. (b) Mercier coefficient. (c) Parallel bootstrap current profile. Here, $(a, b)_t$ denotes control parameters of the temperature profile: $T(\psi)=T_0(1-\Psi^{bt})^{at}$.

3.2. Neoclassical MHD Equilibrium

It is an important issue to evaluate the BSC effect on RFP equilibria from the viewpoint of sustaining the plasma current non-inductively or generating the steady-state equilibrium configuration [13]. For this purpose, we demonstrate a self-consistent calculation of equilibria including neoclassical current effects (neoclassical conductivity and BSC), so called, neoclassical MHD equilibria [7]. Fig. 7(a) illustrates the profile of parallel currents in the neoclassical equilibrium, where $A=2.0$, $p_0=8.4$ kPa ($\beta_t=0.20$), parabolic pressure profile and circular cross-section. The effect of bootstrap current on RFP equilibrium is obvious from these figures and it is observed that a hollow current profile, which is one of typical features of neoclassical equilibrium, is generated even with $F_{bs}=0.40$. The Ohmic current ratio is reduced in the neoclassical equilibrium because of the large F_{bs} , thus the loop voltage is reduced. Fig. 7(b) shows the comparison of q -profiles in classical and neoclassical equilibria. In the neoclassical case, q increases rapidly near the magnetic axis due to the hollow equilibrium current profile, and then it enhances the local and global magnetic shears, which is favorable to the stability.

It is possible to attain neoclassical equilibria with larger F_{bs} by applying more peaked density profile for a fixed pressure profile and/or a larger κ . The local stability of RFP configuration is improved owing to such neoclassical effect because its flattened q -profile around the axis is sloped. Fig. 8 shows that the Mercier mode is stabilized in the neoclassical equilibrium even for the case of a peaked pressure profile, *e. g.*, $\beta_t=0.19$ and $F_{bs}=0.67$ when $(a_p, b_p)=(2.0, 1.0)$ and $\kappa=1.4$. It is noteworthy that the neoclassical equilibrium for any pressure profiles in Fig. 6 can be stable against the Mercier mode, especially for the case of flat pressure/temperature profiles and $\kappa=2.0$, *e. g.*, $\beta_t=0.6$. To obtain a stable equilibrium against the localized modes with simultaneous high β and high F_{bs} , one must search for the optimum combination of

equilibrium parameters such as pressure/temperature profiles, cross-sectional shape and so on. The stability against the kink mode is also required to be surveyed because the PRSM condition of uniform j_p/B_p -profile is not satisfied in the neoclassical MHD equilibrium.

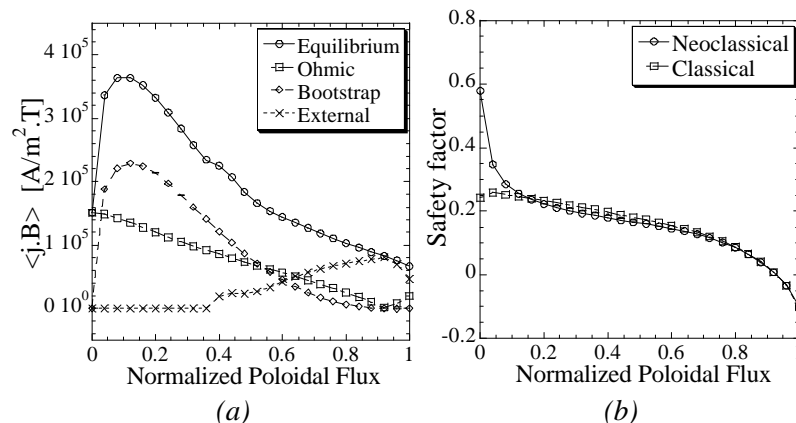

FIG.7. (a) The flux surface averaged parallel current profiles $\langle \mathbf{j} \cdot \mathbf{B} \rangle_{eq} = \langle \mathbf{j} \cdot \mathbf{B} \rangle_{Ohmic} + \langle \mathbf{j} \cdot \mathbf{B} \rangle_{BS} + \langle \mathbf{j} \cdot \mathbf{B} \rangle_{Ex}$ in the neoclassical equilibrium. (b) The comparison of q -profiles in classical and neoclassical equilibria.

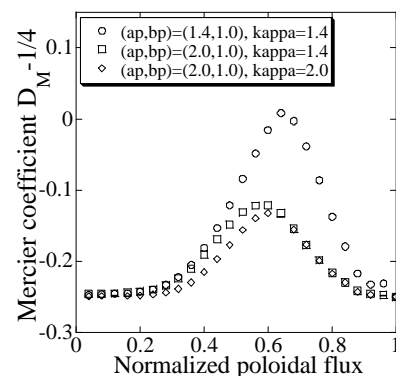

FIG. 8. Mercier coefficient in the neoclassical equilibrium.

3. Conclusion

In summary, the critical β of RFP plasma against localized modes is calculated by different models. β decreases with decrease of A , but it is effectively compensated by edge current modification. The consideration of neoclassical effect in the equilibrium profile results in the significant amount of BSC, which may help the non-inductive current drive and enhancement of shear stabilization in the core region. From both calculations with different models, $\beta \sim 0.2$ is stable at $A = 2$. These database supports strongly the potentiality of the dynamo-mode control and high β confinement in a small aspect ratio RFP. The planned device ($A \sim 2$, $a \sim 0.25$ m, $I_p \sim 100$ kA) will help to develop such a concept innovation toward an advanced RFP reactor.

The first part of this work was financially supported by the Ministry of Education, Culture, Sport, Science and Technology under the counsel of Atomic Energy Commission, Japan.

References

- [1] Escande, D. F., *et al.*, Phys. Rev. Lett. **85** (1999) 1662.
- [2] Sarff, J. S., *et al.*, Phys. Rev. Lett. **78** (1997) 62.
- [3] Ho, Y. L., Schnack, D. D., *et al.*, Phys. Plasmas **2** (1995) 3407.
- [4] Hayase, K., Sugimoto, H., *et al.*, 43rd Annual Meeting of DPP, APS (Long Beach, 2001).
- [5] Nagamine, Y., Shiina, S., *et al.*, 28th EPS Conf. Control. Fusion and Plasma Phys. (Madeira, 2001).
- [6] Mercier, C., Nucl. Fusion **1** (1960) 47.
- [7] Tokuda, S., Takeda, T., Okamoto, M., J. Phys. Soc. Jpn. **58** (1989) 871.
- [8] Kondoh, Y., J. Phys. Soc. Jpn. **58** (1989) 489.
- [9] Skinner, D. A., Prager, S. C., Todd, A. M. M., Nucl. Fusion **28** (1988) 306.
- [10] Hayase, K., *et al.*, IEA/RFP Workshop (2002, Stockholm).
- [11] Hirshman, S. P., Phys. Fluids **31** (1988) 3150.
- [12] Ehst, D. A., Kenneth Jr., E., Weston Jr., M. S., Nucl. Technology **43** (1979) 28.
- [13] Shiina, S., IEA/RFP Workshop (2002, Stockholm).