

수출전락형연구로  
전기 계통 설계 요건

Design Requirement for  
Electrical System of an Advanced Research Reactor

# 제 출 문

한국원자력연구소장 귀하

본 보고서를 2004년도 “수출전략형연구로 계통설계해석” 과제의 기술보고서로 제출합니다.

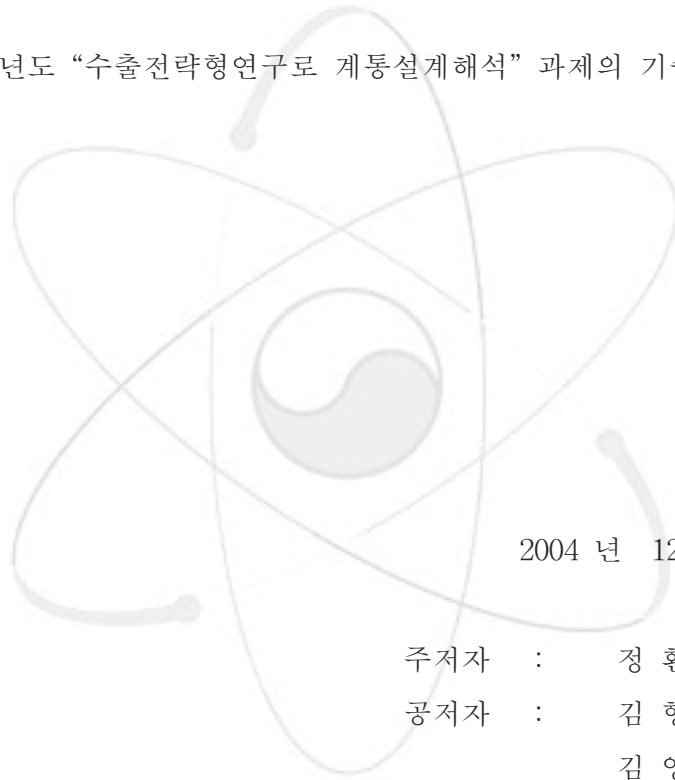

2004 년 12 월

주저자 : 정 환 성  
공저자 : 김 형 규  
          김 영 기  
          우 종 섭  
          류 정 수

## 요 약

하나로의 성공적인 건설, 운영 기술을 바탕으로 새로운 연구용 원자로를 개발하고 있다. 현재 노심 및 핵연료를 설계 중에 있으며, 공정이나 전기, 계측제어분야는 개념 설계를 수행하고 있다.

본 연구를 통하여 새로운 연구용 원자로의 전기 계통 설계에 필요한 요건들은 도출하였다. 보조 계통인 전기 계통도 원자로 설계 기본 원칙인 안전성 향상, 신뢰도 향상, 경제성 확보등을 성취할 수 있도록 개념을 설정 하였다. 본 설계요건은 새로운 연구로의 고압 수전 계통, 저압 배전계통, 비상전원 계통 및 케이블계통 설계에 기본이 될 것이다.

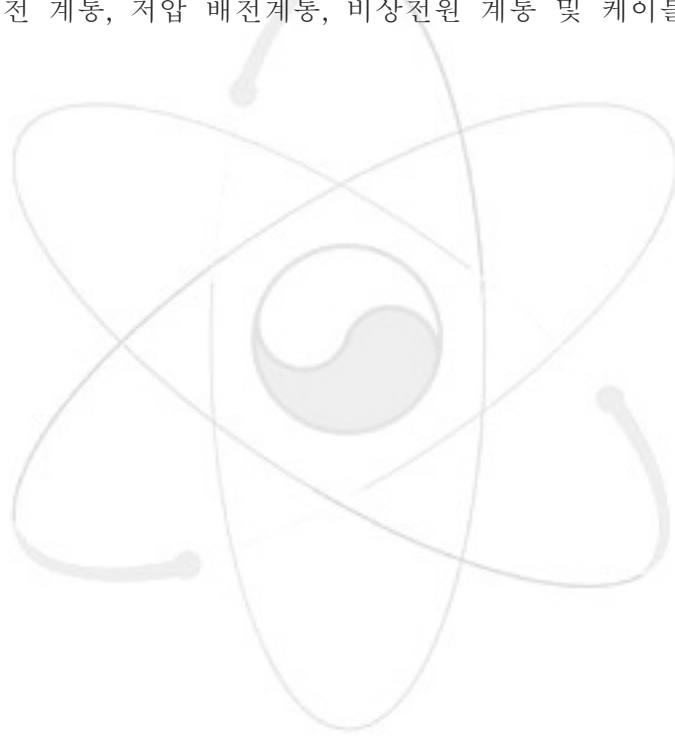

## Abstract

An advanced research reactor is being designed since 2002 and the conceptual design has been completed for the several types of core up to this year. Also the fuel was designed for the potential cores. But the process system, the I&C system, and the electrical system design are under pre-conceptual stage. The conceptual design for those systems will be developed in the next year.

Design requirements for the electrical system were set up to develop conceptual design. The same goals as reactor design - enhance safety, reliability, and economy- were applied for the development of the requirements. Also the experience of HANARO design and operation was based on.

The design requirements for the power distribution, standby power supply, and raceway system will be used for the conceptual design of electrical system.

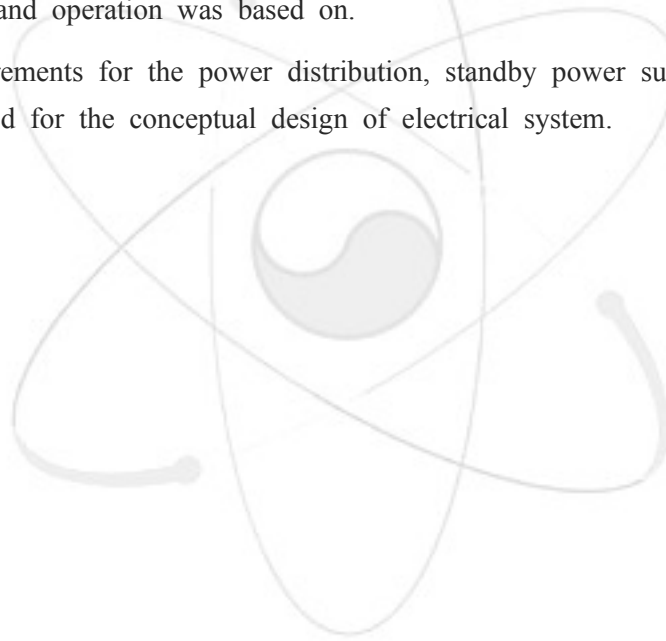

# Table of Contents

1. INTRODUCTION .....	1
2. FUNCTIONAL REQUIREMENTS .....	3
3. PERFORMANCE REQUIREMENT .....	4
4. INTERFACING SYSTEM .....	11
5. DESIGN LIMITS AND STRENGTH REQUIREMENTS .....	12
6. SEISMIC REQUIREMENTS .....	13
7. DESIGN CONSTRAINTS .....	14
8. ENVIRONMENTAL REQUIREMENTS .....	15
9. RELIABILITY REQUIREMENTS .....	16
10. MAINTAINABILITY REQUIREMENTS .....	17
11. IN-SERVICE INSPECTIONS .....	18
12. SAFETY REQUIREMENTS .....	19
13. STANDARDS AND CODES .....	20
14. QUALITY ASSURANCE REQUIREMENTS .....	32
15. OTHER REQUIREMENTS .....	33
16. SUMMARY .....	34
17. REFERENCES .....	35

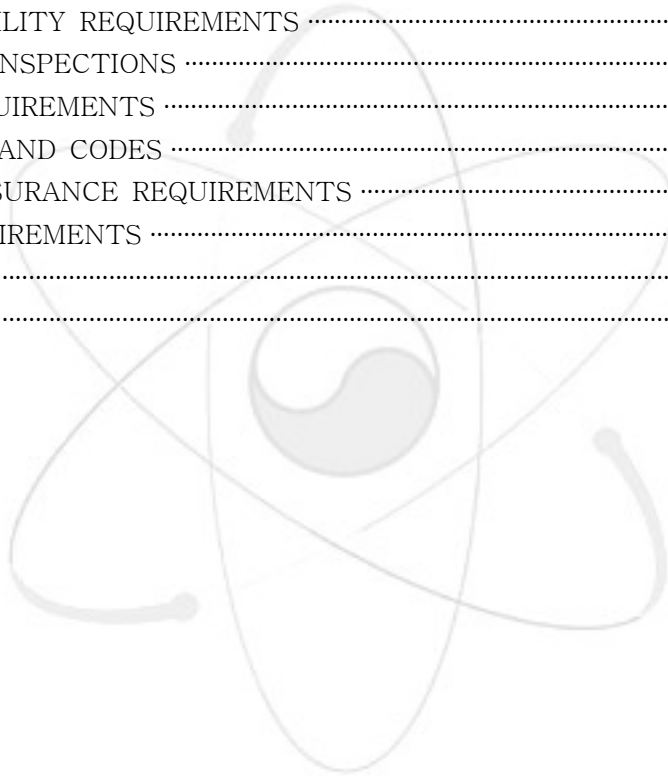

# 1. INTRODUCTION

This report is for the design of electrical system for an advanced research reactor. The electrical system has three major subsystems - the off-site power supply system, the on-site plant electrical power system, and the building service system.

The off-site power supply system for the advanced research reactor refers to those facilities necessary to deliver electrical power to the reactor site.

The on-site plant electrical power system, and the building service system. consists of subsystems as follows

- Main connection and primary power distribution system
- Secondary power distribution system
- Emergency power supply system
- Uninterruptible power supply system

Main connection means receiving high voltage(6.6kV) power from the off-site power substation. and primary power distribution means high voltage (6.6kV) distribution for plant service.

The secondary power distribution system consists of load centers, motor control centers, and distribution panels. The system distributes power at 460V, 3 phase, to the essential loads (motors, heaters, lightings, etc.) The system consists of motor control centers , load centers and an MCC's

The emergency power supply is a standby on-site ac power supply for all critical and essential equipment for the reactor safety and the personnel safety.

The uninterruptible power supply system provides reliable AC and DC power to the critical electrical loads without interruption upon failure of the normal power.

Requirements for the power distribution system and the cabling system are addressed in the following categories. But building service systems are not included.

Included categories are as follows;

- Function
- Performance
- Interfacing
- Design limits and strength
- Seismic
- Design constraints
- Environmental
- Reliability
- Maintainability
- In-service inspections
- Safety

- Standards and codes
- Quality assurance
- Others

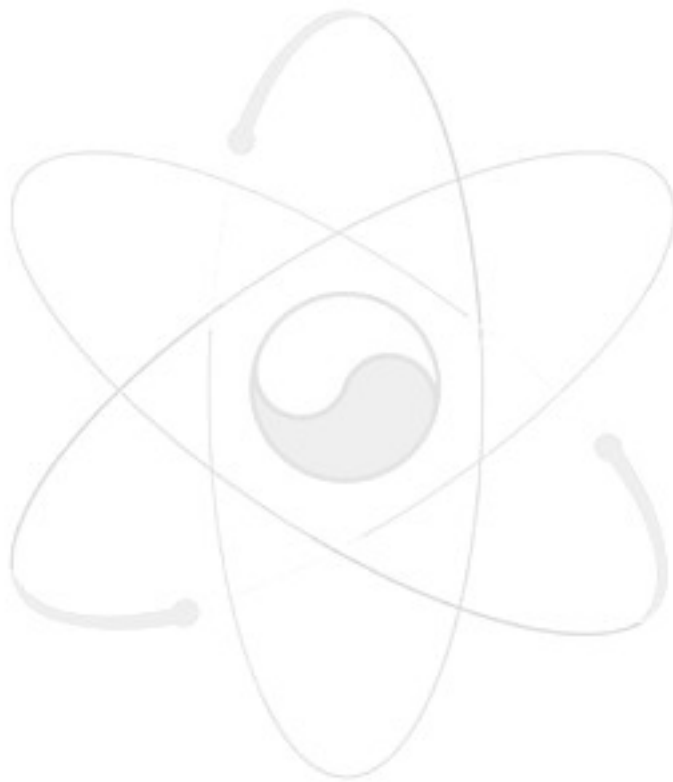

## 2. FUNCTIONAL REQUIREMENTS

- 1.1. The function of the off-site power supply system is the delivery of sufficient electrical power to the reactor site. Power for the facility internal requirements, which constitute the plant electrical power system, is supplied from the two sources.
- 2.1. The primary power distribution system is to receive electric power from 6.6kV distribution line and distribute power to load centers and high capacity motors above 250HP.
- 2.2. The secondary power distribution system is designed to provide reliable power to all low voltage loads during normal operation. Loss of this power shall be considered as abnormal, during which time the emergency power supply shall supply all critical loads.
- 2.3. The secondary power distribution system consist of load centers, motor control centers, and emergency power supply.
- 2.4. Each 460V load center shall be fed from 6.6kV switchgear and supply power to 460V MCC, motors rated from 60 through 250 HP and non-motor loads from 100 through 400 KW.
- 2.5. Each 460V MCC distributes power to the small loads : motor loads less than 60 HP and non-motor loads less than 100 KW.
- 2.6. The emergency power supply shall provide an alternate power for the operation of emergency equipment or safety system in the event of normal power outage.
- 2.7. The MCC shall consist of vertical sections fabricated of sheet steel, shaped and reinforced to form a rigid, free standing, completely enclosed structure bolted to form a panel.
- 2.8. Uninterruptible power supply systems are both 120V AC and 24V DC.
- 2.9. Uninterruptible power supply shall be fed from 460V emergency motor control center which have an emergency diesel generator as stand-by power source.
- 2.10. 24V DC Uninterruptible Power Supply provides uninterruptible DC power for the reactor protection system and other Instrumentation & Control.



### 3. PERFORMANCE REQUIREMENT

#### 3.1. Main Connection

- 3.1.1. Electric power for a new research reactor is fed from the main substation which is connected to the utility transmission grid.
- 3.1.2. The main substation is located near to reactor site. There will be two incoming lines from the utility substations that are located on the different area
- 3.1.3. Two 6.6kV lines shall be provided to on-site electric power system from the main substation and shall have same phase angles to transfer without synchro-check. Each line shall have sufficient capability to supply electric power for start-up, shutdown and/or normal operation of the reactor.
- 3.1.4. The 6.6kV lines shall be provided with electrical protective relays and circuit breaker.

#### 3.2. Primary Power Distribution

- 3.2.1. The 6.6kV switchgear of primary power distribution system is located in the main electric power distribution room and supplies power for all of electrical loads of the reactor facility.
- 3.2.2. Differential, over-current, and ground relaying shall be applied for the isolation of faulty switchgear and incoming circuits and over-current and ground relaying for the tripping of faulty feeder circuits. Selectivity is provided in over-current and ground protection systems to limit the faulty area to the specific faulty load.
- 3.2.3. The switchgear shall be designed to provide reliable power to all unit loads at suitable voltage level during normal and abnormal phase of operation.
- 3.2.4. In order to provide electrical power with higher than usual reliability to the plant service loads, an automatic and manual transfer system shall be applied which ensures continuity of supply in the event of a failure of the sources.
- 3.2.5. The enclosure of switchgear shall be provided spaces for the future loads.
- 3.2.6. The interrupting capacity of switchgear shall be based on the available short circuit level.
- 3.2.7. The interrupting rating of circuit breaker shall be sized in terms of present and future system capabilities.
- 3.2.8. Breakers shall be removable drawout with self-coupling primary and secondary disconnecting contacts.
- 3.2.9. Breakers shall be electrically and mechanically trip free and shall have anti-pumping features.
- 3.2.10. Provisions shall be made for tripping the breakers manually and a

mechanical "Close-Trip" indicator shall be provided on each breaker.

3.2.11. Adequate metering and instrumentation shall be provided for each feeder, such as ammeter, voltmeter, etc.

### 3.3. Load Center

3.3.1. The load center shall be of the metal enclosed, drawout, air circuit breaker type with bus bar construction.

3.3.2. Enclosures shall be free standing steel structures for indoor service. All compartments shall have removable hinged doors on the front and the rear side.

3.3.3. Each load center shall be provided with a 6600 V to 460 V, 3 phase, 60 HZ, transformer.

3.3.4. The buses shall be of sufficient cross section area to carry the continuous rated current and shall be sized such that they are not over loaded during normal operation.

3.3.5. The bus connections shall have momentary current ratings corresponding to the momentary or short circuit rating of the connected circuit breakers.

3.3.6. The entire bus system shall be supported by heavy duty high dielectric strength insulating material capable of withstanding without damage all mechanical and thermal stresses resulting from short circuit currents at least equal to those specified for circuit breakers.

3.3.7. Circuit breakers shall be of the drawout type, three pole, single-throw, electrically and mechanically trip free.

3.3.8. All feeder circuit breakers shall be equipped with over current tripping devices, one for each pole.

3.3.9. Static over current trip devices shall be provided for each breaker where required.

3.3.10. Breaker over current trip elements shall be adjustable with long time, and/or instantaneous trip characteristics as specified.

3.3.11. The circuit breakers shall be capable of manual operation for closing and tripping in the disconnected position for maintenance.

3.3.12. The circuit breakers shall be provided with a mechanical interlock to prevent the breaker from being inserted into or withdrawn from the connected position when the circuit breaker is closed. All connections shall be disconnected.

3.3.13. It shall be possible to close the compartment door after padlocking the breaker in the "open" position. A positive mechanical "CLOSE-OPEN" position indicator shall be provided on each breaker.

- 3.3.14. An indicator showing when the stored energy mechanism is charged shall be provided.
  - 3.3.15. Red-green indicating lights shall be provided for each circuit breaker to indicate when the breaker is in the closed or open position respectively.
  - 3.3.16. The load centers shall have provisions for top entrance of power and control cable.
  - 3.3.17. Transformers shall be dry type and shall be provided with ventilated metal enclosures with removable bolted panels.
  - 3.3.18. Each load center transformer shall be provided with forced cooling fans. The fan shall provide a 33.3 percent increase above the self-cooled capacity, complete with winding temperature sensing device and control equipment.
  - 3.3.19. The low voltage neutral point of the wye connected transformers shall be connected to the load center ground bus through a removable link.
- 3.4. Motor Control Center
- 3.4.1. The motor control center (MCC) shall be standard industrially proven type and shall be conservatively applied. MCC shall have approximately 20 percent spare circuit breakers, motor starters and/or spaces.
  - 3.4.2. The MCC bus shall have sufficient capacity and shall be connected so that overloading under any conditions of operation is prevented.
  - 3.4.3. All MCC motor starter circuits shall be full-voltage non-reversing or full-voltage reversing, combination type with breakers, contactors, and individual control transformers.
  - 3.4.4. The combination starters and circuit breakers shall be fitted in individual compartments with hinged door.
  - 3.4.5. Each combination starter shall be fitted with circuit breaker and magnetic contactor with thermal overload protection in each leg and 460 /110 V control transformer.
  - 3.4.6. Control transformer shall be of uniform rating for similar units and will be sized to provide for addition of relays and other loads.
  - 3.4.7. Starter size shall be based on motor HP, voltage, and type of service.
  - 3.4.8. Each full voltage reversible starter and non-reversible starter shall be provided with two and one interposing relay respectively. The relay shall be 24V DC, with 2 normal open and 2 normal close contacts, wired back to the terminal block.
  - 3.4.9. The MCC shall consist of vertical sections fabricated of sheet steel, shaped and reinforced to form a rigid, free standing, completely enclosed structure bolted to form a panel.

- 3.4.10. Main horizontal bus shall be of copper, mounted at the top. The ground bus and the neutral bus shall be mounted in the bottom of vertical sections. Incoming cable entries shall be from the top of motor control center.
- 3.4.11. All control wiring shall be brought into a common terminal section, from where a multi-conductor cable will be run to a junction box in the control room or the reactor area, if necessary.
- 3.4.12. The interrupting rating of the MCC components shall be based on the available short circuit level.

### 3.5. Emergency Power Supply

- 3.5.1. The emergency power supply system shall consist of 6600V, 60Hz, three phase generator, driven by a fast starting diesel engine and 460V emergency load centers and MCC's.
- 3.5.2. The generators are of rotating field, synchronous type, air cooled, and equipped with air filters.
- 3.5.3. The initial excitation power source shall be independent on the normal power.
- 3.5.4. The steady state voltage regulation shall not exceed + 0.5 percent from no load to full load.
- 3.5.5. A manual voltage regulator control shall permit setting the generator output voltage level when the automatic voltage regulator is by-passed temporarily.
- 3.5.6. In the event of a normal power failure, a signal shall be provided to initiate the automatic starting of the diesel generator.
- 3.5.7. Diesel generator starting time (start to on-load) shall be less than 60 seconds.
- 3.5.8. Inter-locks shall prevent automatic closing the diesel generator breaker into an energized or a faulted bus.
- 3.5.9. Following restoration of normal power, a manual transfer will be accomplished by tripping the diesel generator feeder breaker and closing the normal power feeder breaker respectively.
- 3.5.10. The breaker feeding the emergency power shall trip in case of loss of normal power supply. This is to prevent emergency power supply feeding the normal power bus.
- 3.5.11. The duration for which emergency diesel generators are supposed to operate shall be 24 hours without fuel oil replenishment.
- 3.5.12. The emergency diesel generator shall have two-hour overload capability (110%) of its rating.

### 3.6. 120V AC Uninterruptible Power Supply

- 3.6.1. The uninterruptible Power Supply (UPS) shall be 120 Vac single phase 60Hz.

- 3.6.2. The system shall be triplicated to increase reliability of power supply to the critical loads.
- 3.6.3. Each 120V AC UPS system shall consist of a UPS unit (a rectifier charger an inverter a transfer switch and a distribution panel) a battery and a regulating transformer for by-pass supply.
- 3.6.4. The rectifier charger portion of UPS unit shall receive 460 Vac ( $\pm 10\%$ ) 3 phase from emergency power.
- 3.6.5. Charger convert this power to regulated DC power.
- 3.6.6. The DC power shall be fed simultaneously to the battery for charging and the inverter.
- 3.6.7. The inverter convert the DC power to precise AC power and feed it to the critical load.
- 3.6.8. The maximum total harmonic distortion in the output wave shall not exceed 3% for loads between 10% and 100% at 0.8 lag to 0.9 lead power factor for minimum to maximum input voltage.
- 3.6.9. On 100% step load change, the voltage shall not vary more than  $\pm 8\%$  and recover to  $\pm 2\%$  within 100 msec.
- 3.6.10. During normal operation, UPS is fed from emergency power and supplies power to loads through rectifier/charger and inverter.
- 3.6.11. On the failure of emergency power bus, the power source shall be automatically changed from the bus to the batteries of UPS in order to supply power to the loads without interruption.
- 3.6.12. When the inverter is controlled by internal free running oscillator in case of loss of emergency power, the output frequency regulation of UPS shall be 60 Hz  $\pm 0.1\%$ .
- 3.6.13. When the emergency power bus is restored, the UPS shall regain normal operation automatically and the batteries shall start recharging.
- 3.6.14. If the emergency power bus is not restored, the UPS shall automatically shut itself down when the discharge limit of the battery is reached.
- 3.6.15. When malfunction of UPS unit occurs, the power is supplied from emergency power bus through a by-pass transformer.
- 3.6.16. When the UPS unit is restored, the transfer to UPS unit is accomplished by push-button manually.
- 3.6.17. The transfer time shall be less than 4 msec.
- 3.6.18. The static switch shall be capable of supplying 125% rated current for 15 minutes and 1,000% for one cycle.
- 3.6.19. A transfer of load to the bypass supply shall take place for any of the

following abnormal conditions:

- Inverter overload capability exceeded
- Inverter output voltage exceeds the overload trip level

3.6.20. Manual bypass switch shall be provided a means of manually bypassing the inverter and static transfer switch for maintenance or troubleshooting.

### 3.7. 24V DC Uninterruptible Power Supply

3.7.1. The system shall be rated to 24 Volts output and triplicated to provide DC power for three (3) protection channels respectively.

3.7.2. The battery charger shall be rated to supply the largest combined demand of all the steady-state loads plus the charging load of the battery from discharged state of 1.75 volts/cell to the normal value of 2.25 volts/cell within 10hours.

3.7.3. Battery charger shall have a constant output voltage and shall be suitable for 460 Vac  $\pm 10\%$  60 Hz 3 phase input power supply.

3.7.4. Following features shall be incorporated in the battery charger.

- 1) Soft start circuit and current limit not less than 120% of continuous current rating.
- 2) Output voltage regulation  $\pm 1\%$  with the following conditions;
  - \* 0 to 100% load
  - \*  $-10^{\circ}\text{C}$  to  $40^{\circ}\text{C}$  ambient
  - \*  $\pm 10\%$  change in input voltage coupled with  $\pm 5\%$  variation in input frequency
- 3) Float voltage nominal setting : 2.15 volts/cell
- 4) Float voltage adjustment :  $\pm 10\%$
- 5) Equalize voltage nominal setting : 2.33 volts/cell
- 6) Equalize voltage adjustment :  $\pm 10\%$  independent of float voltage adjustment
- 7) AC & DC circuit breakers
- 8) Meters and status & alarm indicators
- 9) Reverse current protection
- 10) AC and DC surge protection

3.7.5. All batteries shall be rated identically.

3.7.6. Each battery shall have sufficient capacity to independently supply the required loads for at least 60 minutes following a loss of emergency power, (and/or battery charger failure) from an initial float-charge condition of 2.15 volts/cell to a final state of 1.75 volts/cell (average).

3.7.7. Sizing of the batteries shall be based on a minimum temperature of  $5^{\circ}\text{C}$  in the battery room for the 60 minutes service period.

3.7.8. Battery room shall be provide with a proper ventilation.

3.7.9. A tray shall be provided for collecting spilled acid from batteries.

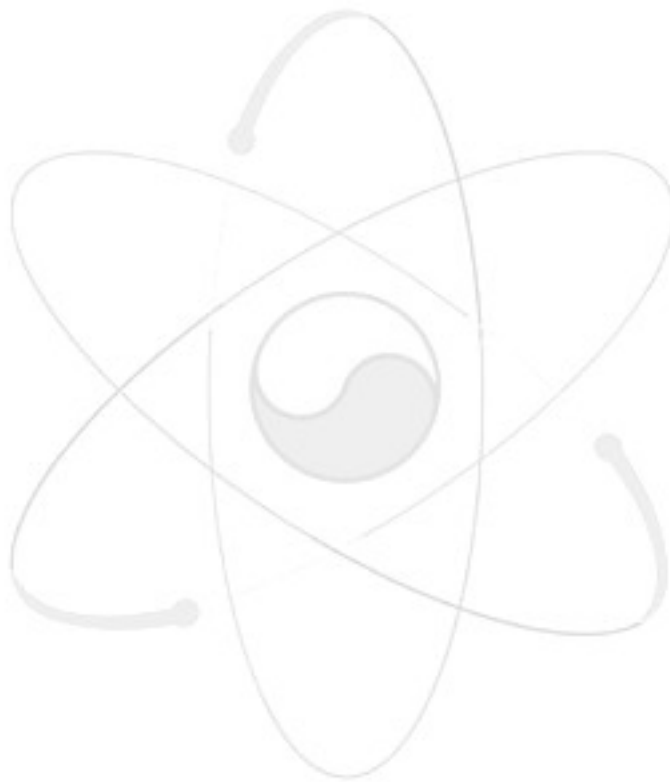

## 4. INTERFACING SYSTEM

### 4.1. Constraints Imposed on Ventilation System

4.1.1. The electrical distribution room, the diesel generator room and the MCC room in which switchgear, load center, diesel generator and motor control centers respectively are located shall be ventilated so as to maintain the proper ambient temperatures for optimum operation.

4.1.2. Provisions shall be made for sufficient diffusion and ventilation of the gases from the battery to prevent the accumulation of an explosive mixture.

### 4.2. Basic Requirements Imposed on Instrumentation and Control.

4.2.1. All faulty conditions of UPS and battery charger shall be displayed by HMI screen readouts.

4.2.2. The annunciation windows shall be provided to annunciate failure of power buses.

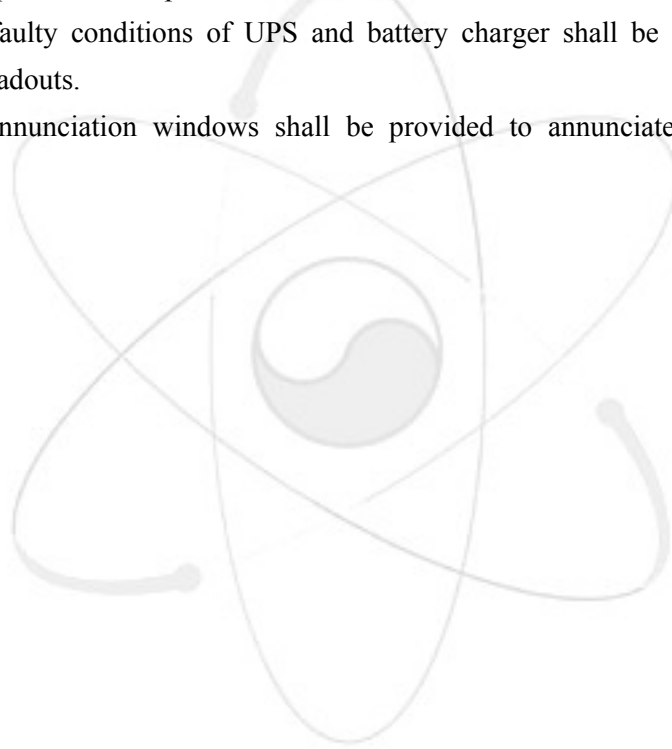



## 5. DESIGN LIMITS AND STRENGTH REQUIREMENTS

- 5.1. All equipment shall be capable of withstanding all stresses produced by the maximum fault current and all voltage stresses which may be experienced during operation.
- 5.2. All equipment shall have sufficient insulation to withstand all the impulse and switching surge stresses.
- 5.3. The inverter section of the UPS must be able to start with only the battery supply available.

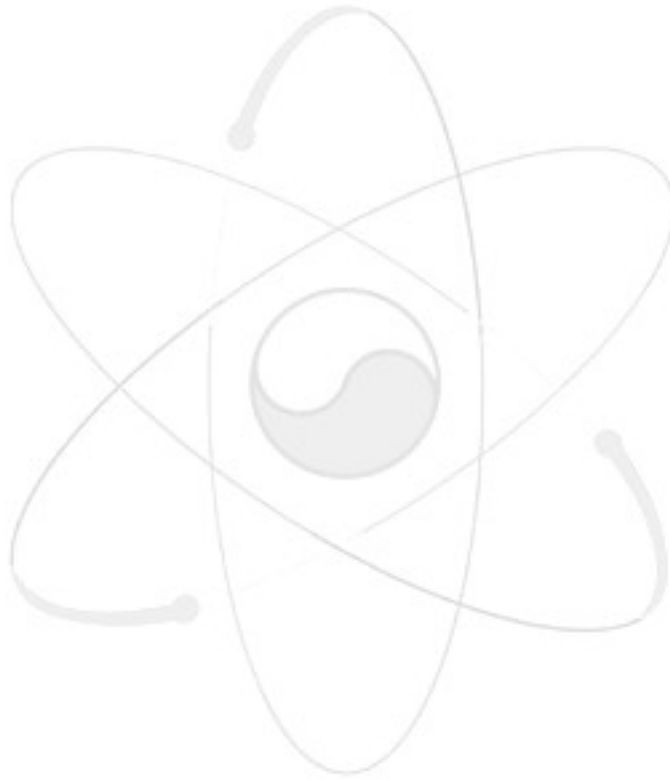

## 6. SEISMIC REQUIREMENTS

- 6.1. The safety-related equipment of UPS units, batteries and 24V DC distribution panels which must operate during loss of input power and or design basis events shall be qualified seismically and environmentally in accordance with IEEE Std. 344 and 323.
- 6.2. In addition physical separation and electrical isolation shall be provided for the safety-related equipment according to IEEE Std. 384.

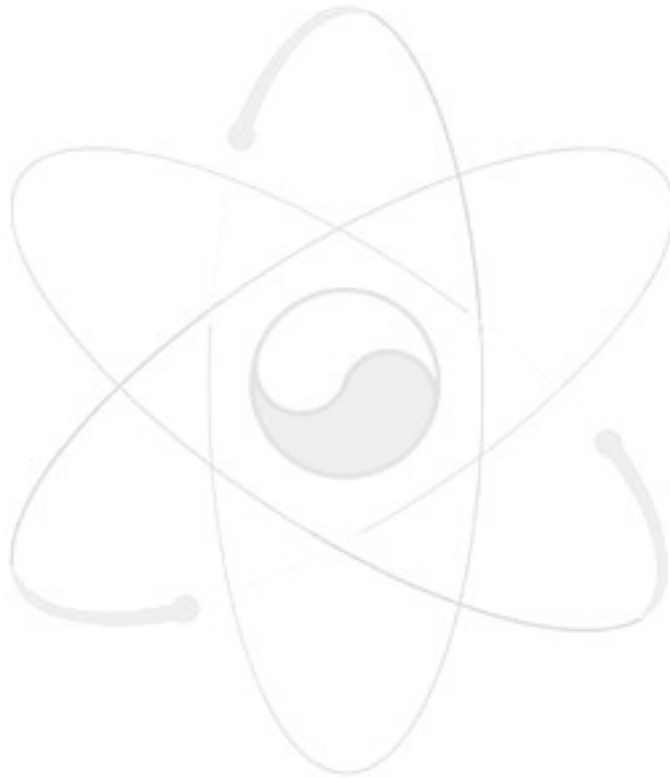

## 7. DESIGN CONSTRAINTS

- 7.1. The designed shipping weight and dimensions shall not exceed the capabilities of transportation and/or on-site available handling equipment.
- 7.2. All control wiring used inside all equipments shall have fire retardant insulation.
- 7.3. Control devices mounted on outside faces of panels shall be mounted within an easy reach and all manual switches shall not be possible for the switch to be between any of its normal operating positions.
- 7.4. Location of the equipment shall be such that any possible objects falling from above must not activate any the control and/or protective functions.
- 7.5. Circuit breakers of different ratings must not be interchangeable.
- 7.6. Access space shall be provided in the back and in the front of the load center and MCC recommended by the manufacturer.

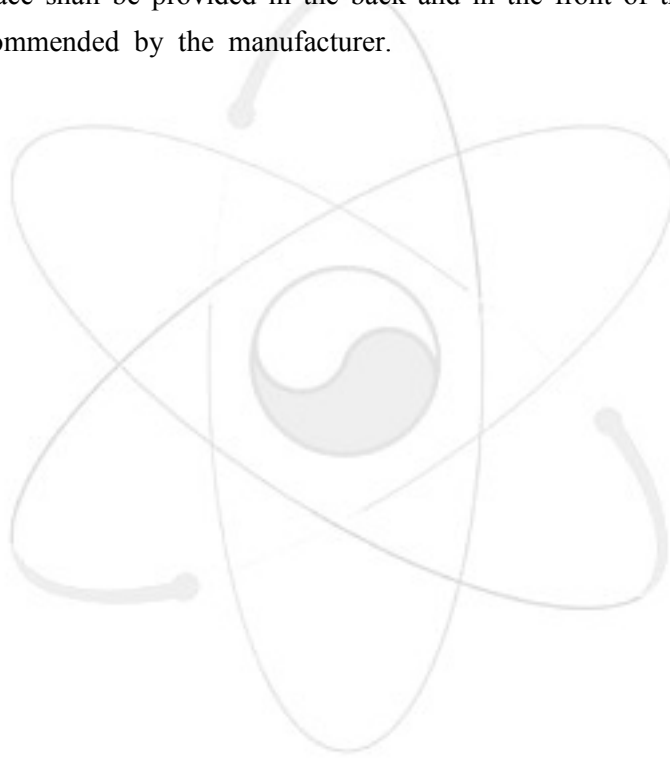

## 8. ENVIRONMENTAL REQUIREMENTS

8.1. The system is required to function under the following ambient conditions :

- Temperature :	Outdoor	Indoor
Maximum	40°C	40°C
Minimum	-25°C	10°C
- Relative humidities :	Outdoor	Indoor
Annual average	66 percent	NA
Minimum	0 percent	0 percent
Maximum	100 percent	100 percent
- Pressure :	Atmospheric pressure	

8.2. Equipment located indoor shall be designed to operate without any reduction in normal life expectancy, within the minimum and maximum range of temperature and humidity.

8.3. Internal ventilation of indoor equipment shall be such that the equipment will operate successfully with an ambient temperature 40°C, if this is not practicable, that equipment should be located in air conditioned room.

8.4. Noise level of UPS shall not exceed 60db.

## 9. RELIABILITY REQUIREMENTS

- 9.1. The system shall be designed such that there is low probability of loss of power.
- 9.2. All the safety-related system will be designed to maintain unavailability target of safety systems to less than  $10^{-3}$  h/h.

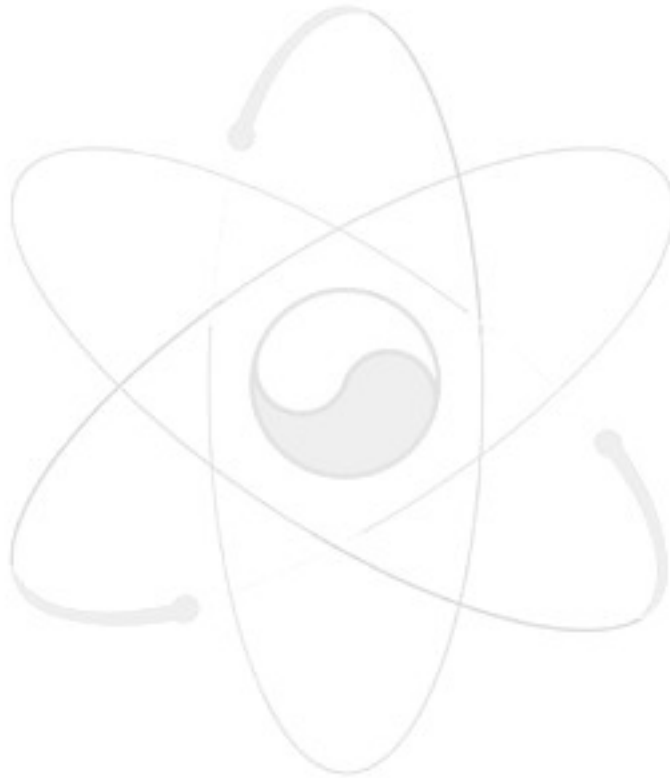

## 10. MAINTAINABILITY REQUIREMENTS

- 10.1. Where redundant equipment are provided, the equipment shall be arranged so that one equipment can be isolated for maintenance and testing without affecting the other equipment or the total process system.
- 10.2. Grounding facilities must be provided to ground electrical equipment when required to provide safe working conditions. Where ground test devices cannot be applied, locations must be provided to attach portable ground.
- 10.3. Equipment which require regular maintenance shall be kept to a minimum. They shall be located in an accessible area which is free of extreme environmental conditions such as temperature, pressure, moisture, etc.
- 10.4. Types and quantities of tools required for performing maintenance tasks should be minimized.
- 10.5. Manufacturer's service manuals with detailed instructions on maintenance, troubleshooting, repair procedures shall be available at site for prompt reference.

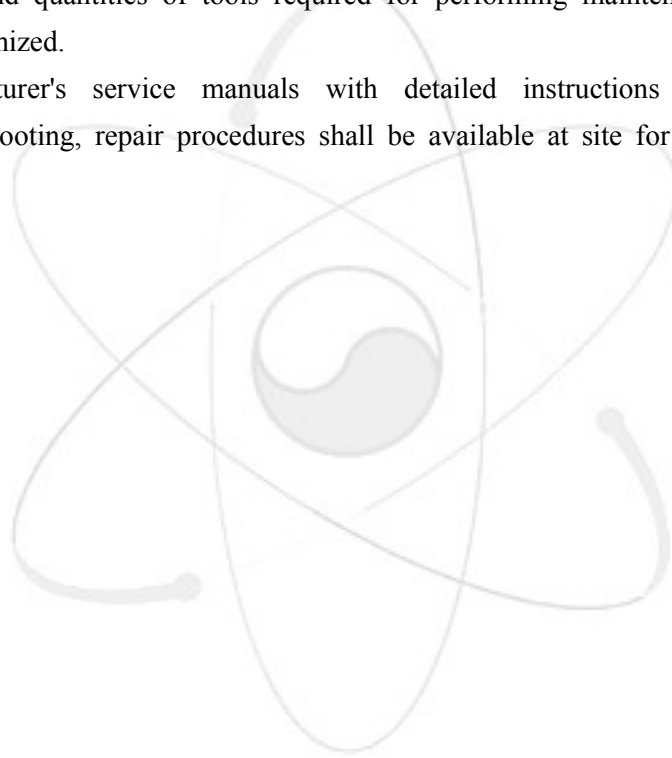

## 11. IN-SERVICE INSPECTIONS

- 11.1. The equipment shall be inspected at regular intervals, as described in manufacturer's operation and maintenance manuals. The operation and maintenance manuals shall be prepared giving procedures for the inspection of the system.
- 11.2. Detail alarm, indication and built-in test equipment is required in order to facilitate in-service inspection.

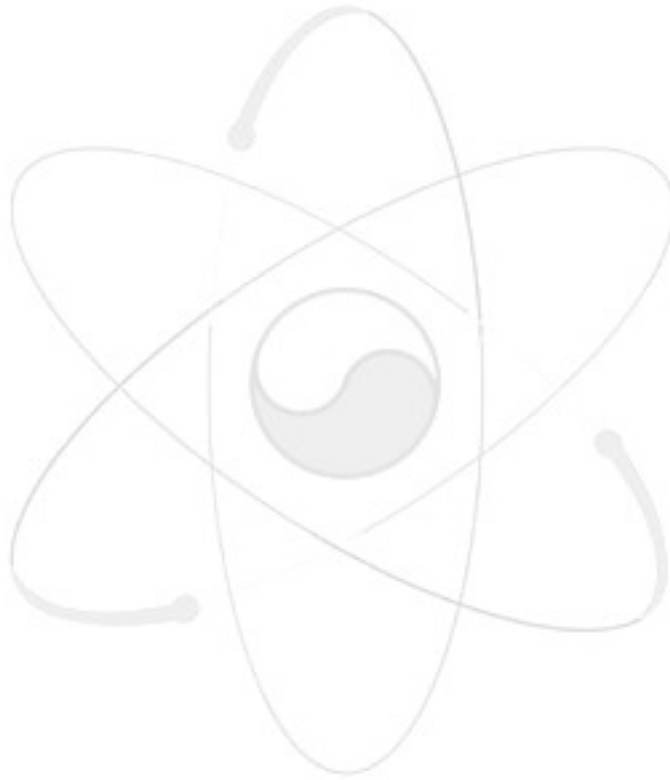

## 12. SAFETY REQUIREMENTS

### 12.1. Nuclear Safety Requirements

Not applicable.

### 12.2. Radiation Safety Requirements

Not applicable.

### 12.3. Industrial Safety Requirements

12.3.1. Facilities shall be provided for grounding of all electric equipment to provide safe working conditions for testing and maintenance.

12.3.2. All switchgear shall be of "dead front" design.

12.3.3. All equipment shall be selected with a safety margin.

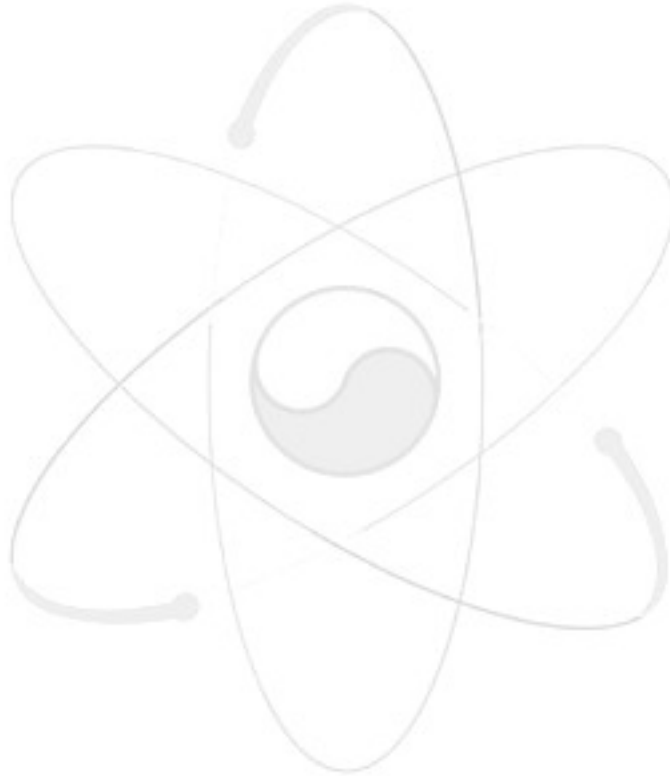



### 13. STANDARDS AND CODES

The system shall be designed in accordance with the following standards and codes. But the followings are minimum of the applicable standards and codes.

American National Standards Institute (ANSI)

- B18.2.1 Square and Hex Bolts, Screws, Inch Series
- B18.2.2 Square and Hex Nuts
- C2 National Electrical Safety Code
- C2.1 Rules for Installation and Maintenance of Electric Supply Stations and Equipment
- C2.2 The Safety Rules for the Installation and Maintenance of Electric Supply and Communication Lines
- C33.38 Safety Standards for Panelboards
- C37.09 Standard Test Procedure for AC High-Voltage Circuit Breakers Rated on a Symmetrical Current Basis
- C37.1 Standard Definition, Specification and Analysis of Systems Used for Supervisory Control, Data Acquisition and Automatic Control
- C37.04-79 Standard Rating Structure for AC High-Voltage Circuit Breakers Rated on a Symmetrical Current Basis
- C37.06-87 AC High-Voltage Circuit Breakers Rated on a Symmetrical Current Basis
- C37.12 Guide Specifications for AC High-Voltage Circuit Breakers Rated on a Symmetrical Current Basis and a Total Current Basis
- C37.13 Standard for Low-Voltage AC Power Circuit Breakers Used in Enclosures
- C37.14 Standard for Low-Voltage DC Power Circuit Breakers Used in Enclosures
- C37.16-88 Preferred Ratings, Related Requirements, and Application Recommendations for Low-Voltage Power Circuit Breakers and AC Power Circuit Protectors
- C37.20 Assemblies, including Metal-Enclosed Bus
- C37.20.1-87 Metal-Enclosed Low-Voltage Power Circuit-Breaker Switchgear
- C37.20.2-87 Metal-Clad and Station-Type Cubicle Switchgear
- C37.23-87 IEEE Guide for Metal-Enclosed Bus and Calculating Losses in Isolated-Phase Bus
- C37.30 Definitions and Requirements for High-Voltage Air Switches, Insulators and Bus Supports.
- C37.32 Preferred Ratings, Manufacturing Specification, and Application Guide for High-Voltage Air Switches, Bus Supports, and Switch Accessories.
- C37.35 Guide for the Application, Insulation, Operation, and Maintenance of High-Voltage Air Disconnecting and Load Interrupter Switches
- C37.90 Standard for Relays and Relay Systems Associated with Electric Power

	Apparatus
C37.91-85	Guide for Protective Relay Applications to Power Transformers C37.90a Guide for Surge Withstand Capability Tests
C57.12.00-87	Standard General Requirements for Liquid-Immersed Distribution, Power, and Regulating Transformers
C57.12.01-89	Standard General Requirements for Dry-Type Distribution and Power Transformers Including Those with Solid and/or Resin-Encapsulated Windings
C57.12.10-87	Requirement for Transformers 230kV and Below, 833/958 through 8333/10,417 kVA Single Phase, and 750/862 through 60000/80000/ 100000 kVA Three Phase without Load Tap Changing and 3750/4687 through 60000/80000 kVA with Load Tap Changing
C57.12.70	Terminal Markings and Connections for Distribution and Power Transformers
C57.12.90	Standard Test Code for Liquid-Immersed Distribution, Power, and Regulating Transformers and Guide for Short-Circuit Testing of Distribution and Power Transformers
C57.13	Standard Requirements for Instrument Transformers
C57.16	Requirements, Terminology, and Test Code for Current Limiting Reactors
C57.92-81	Guide for Loading Mineral-Oil Immersed Power Transformers up to and Including 100 MVA with 55°C Average Including Rise
C57.93	Guide for Installation and Maintenance of Oil-Immersed Transformers
C57.96-89	Guide for Loading Dry-Type Distribution and Power Transformers
C57.98	Guide for Transformer Impulse Tests
C62.1	Standard for Gapped Silicon-Carbide Surge Arrestors for AC Power Circuits
C62.2	Guide for the Application of Gapped Silicon-Carbide Surge Arrestors for Alternating Current Systems
C68.1	Measurement of Voltage in Dielectric Test
C76.1	Requirements and Test Code for Outdoor Apparatus Bushings
C80.1	Specification for Rigid Steel Conduit, Zinc Coated
C80.3	Specification for Electrical Metallic Tubing, Zinc Coated
C80.6	Intermediate Metal Conduit (IMC), Zinc Coated
C83.9	Racks, Panels and Associated Equipment
C83.79	Tools, Crimping, Solderless Wiring Devices, Procedures for User Certification
C84.1-89	Electric Power Systems and Equipment
C89.2	Dry Type Transformers for General Applications
N45.2	Quality Assurance Program Requirements for Nuclear Facilities

N45.2.2	Packaging, Shipping, Receiving, Storage, and Handling of Items for Nuclear Power Plants
N45.2.10	Quality Assurance Terms and Definitions
NI95-1976	Fuel Oil Systems for Standby Diesel Generators
N-512	Protective Coatings (Paints) for the Nuclear Industry
S1.13	Methods for the Measurement of Sound Pressure Levels
X3.139-87	Information Systems - Fiber Distributed Data Interface (FDDI) - Token Ring Media Access Control (MAC)
X3.148-88	Information Systems - Fiber Distributed Data Interface (FDDI) - Token Ring Physical Layer Protocol (PHY)
X3.166-90	Fiber Distributed Data Interface (FDDI) Token Ring Physical Layer Medium Dependent (PMD)
X3T9.5/84-49	Fiber Distributed Data Interface (FDDI) Token Ring Station Management
Z55.1	Gray Finishes for Industrial Apparatus and Equipment

American Society of Mechanical Engineers (ASME)

PTC-17 Performance Test Code, Reciprocating Internal Combustion Engines

American Society for Testing and Materials (ASTM)

A725	Specification for Flat Rolled, Grain Oriented, Silicon Iron Electrical Steel
B3	Standard Specification for Soft or Annealed Copper Wire.
B8	Standard Specification for Concentric-Lay Stranded Copper Conductors, Hard, Medium Hard, or Soft.
B33	Standard Specification for Tinned Soft or Annealed Copper Wire for Electrical Purposes
B187	Standard Specification for Copper Bus Bar, Rod and Shapes
B193	Standard Test Method for Resistivity of Electrical Conductor Materials
B230	Standard Specification for Aluminum 1350-H19 Wire for Electrical Purposes
B231	Standard Specification for Concentric-Lay-Stranded Aluminum 1350 Conductors
B232	Standard Specification for Concentric-Lay-Stranded Aluminum Conductors, Coated-Steel Reinforced
B236	Standard Specification for Aluminum Bars for Electrical Purposes (Bus Bars)
B241	Standard Specification for Aluminum and Aluminum-Alloy Seamless Pipe and Seamless Extruded Tube

B308	Standard Specification for Aluminum - Alloy 6061-T6 Standard Structural Shapes Rolled
B342	Standard Method of Test for Electrical Conductivity by Use of Eddy Currents (Alternate Method)
B498	Standard Specification for Zinc-Coated (Galvanized) Steel Core Wire for Aluminum Conductors, Steel Reinforced
D92	Standard Test Method for Flash and Fire Points by Cleveland Open Cup
D96	Standard Test Methods for Water and Sediment in Crude Oil by Centrifuge Method
D117	Standard Guide to Test Methods and Specifications for Electrical Insulating Oils of Petroleum Origin
D129	Standard Test Method for Sulfur in Petroleum Products (General Bomb Method)
D270	Standard Method of Sampling Petroleum and Petroleum Products
D370	Standard Test Method for Dehydration of Oil-Type Preservatives
D808	Standard Test Method for Chlorine in New and Used Petroleum Products (Bomb Method)
D877	Standard Test Method for Dielectric Breakdown Voltage of Insulating Liquids Using Disk Electrodes
D971	Standard Test Method for Interfacial Tension of Oil Against Water by the Ring Method
D974	Standard Test Method for Acid and Base Number by Color - Indicator Titration
D975	Standard Specification for Diesel Fuel Oils
D1275E1	Standard Test Method for Corrosive Sulphur in Electrical Insulating Oils
D1523	Standard Specification for Synthetic Rubber Insulation for Wire and Cable, 90°C Operation
D2477	Standard Test Method for Dielectric Breakdown Voltage and Dielectric Strength of Insulating Gases at Commercial Power Frequencies
D2671	Standard Test Methods for Heat-Shrinkable Tubing for Electrical Use
D2863	Standard Test Method for Measuring the Minimum Oxygen Concentration to Support Candle-Like Combustion of Plastics (Oxygen Index)
E84-1991	Surface Burning Characteristics of Building Materials
E205	Oxygen Combustion Flask, Spec for (R 1986)

Diesel Engine Manufacturers Association (DEMA)

Standard Practices for Low and Medium Speed Stationary Diesel and Gas Engines.

Illuminating Engineering Society (IES)

IES Lighting Handbook, 1987 Edition Application Volume, 1984 Edition Reference Volume  
IES CP-41 Nuclear Power Plant Lighting

Institute of Electrical and Electronic Engineers (IEEE)

- 24-1984 Characteristics and Dimensions for Outdoor Apparatus Bushing
- 32-1972 Standard Requirements, Terminology, and Test Procedures for Neutral Grounding  
Devices
- 80-1986 Guide for Safety in AC Substation Grounding
- 81-1983 Guide for Measuring Earth Resistivity, Ground Impedance and Earth Surface  
Potentials of a Ground System
- 85-1973 Test Procedure for Airborne Sound Measurements of Rotating Electric Machinery
- 113-1985 Guide: Test Procedures for Direct-Current Machines
- 114-1982 Standard Test Procedures for Single-Phase Induction Motors
- 115-1983 Guide: Test Procedure for Synchronous Machines
- 141-1986 Recommended Practice for Electric Power Distribution for Industrial Plants
- 142-1982 Recommended Practice for Grounding of Industrial and Commercial Power  
Systems
- 242-1986 Recommended Practice for Protection and Coordination of Industrial and  
Commercial Power Systems
- 259-1974 Standard Test Procedure for Evaluation System of Insulation for Specialty  
Transformers
- 281-1984 Standard Service Conditions for Power System Communication Equipment
- 308-1980 Standard Criteria for Class 1E Power Systems for Nuclear Power Generating  
Stations
- 317-1983 Standard for Electric Penetration Assemblies in Containment Structures for  
Nuclear Power Generating Stations
- 323-1983 Standard for Qualifying Class 1E Equipment for Nuclear Power Generating  
Stations
- 336-1985 Standard Installation, Inspection, and Testing Requirements for Power,  
Instrumentation and Control Equipment at Nuclear Facilities
- 338-1987 Standard Criteria for the Periodic Surveillance Testing of Nuclear Power  
Generating Station Safety Systems
- 344-1987 Recommended Practice for Seismic Qualification of Class 1E Equipment for  
Nuclear Power Generating Stations
- 352-1987 Guide for General Principles of Reliability Analysis of Nuclear Power  
Generating Station Safety Systems
- 379-1988 Standard Application of the Single Failure Criterion to Nuclear Power

	Generating Station Safety Systems
382-1985	Standard for Qualification for Actuators for Power Operated Valve Assemblies with Safety-Related Functions for Nuclear Power Plants
383-1974	Standard for Type Test of Class 1E Electric Cables, Field Splices and Connections for Nuclear Power Generating Stations
384-1981	Standard Criteria for Independence of Class 1E Equipment and Circuits
387-1984	Standard Criteria for Diesel-Generator Units Applied as Standby Power Supplies for Nuclear Power Generating Stations
420-1982	Standard for the Design and Qualification of Class 1E Control Boards, Panels, and Racks Used in Nuclear Power Generating Stations
422-1986	Guide for the Design and Installation of Cable Systems in Power Generating Stations
450-1987	Recommended Practice for Maintenance, Testing and Replacement of Large Lead Storage Batteries for Generating Stations and Substations
484-1987	Recommended Practice for Installation, Design and Installation of Large Lead Storage Batteries for Generating Stations and Substations
485-1983	Recommended Practice for Sizing Large Lead Storage Batteries for Generating Stations and Substations
494-1974	Standard Method for Identification of Documents Related to Class 1E Equipment and Systems for Nuclear Power Generating Stations
497-1981	Standard Criteria for Accident Monitoring Instrumentation for Nuclear Power Generating Stations
498-1990	Standard Requirements for the Calibration and Control of Measuring and Test Equipment Used in Nuclear Facilities
505-1977	Standard Nomenclature for Generating Station Electric Power Systems
525-1987	Guide for the Design and Installation of Cable Systems in Substations
567-1980	Trial-Use Standard Criteria for the Design of the Control Room Complex for a Nuclear Power Generating Station
572-1985	Standard for Qualification of Class 1E Connection Assemblies for Nuclear Power Generating Stations
577-1976	Standard Requirements for Reliability Analysis in the Design and Operation of Safety Systems for Nuclear Power Generating Stations
603-1991	Standard Criteria for Safety Systems for Nuclear Power Generating Stations
627-1980	Standard for Design Qualification of Safety Systems Equipment Used in Nuclear Power Generating Systems
628-1987	Standard Criteria for the Design, Installation, and Qualification of Raceway Systems for Class 1E Circuits for Nuclear Power Generating Stations

- 634-1978 Standard Cable Penetration Fire Stop Qualification Test
- 650-1990 Standard for Qualification of Class 1E Battery Chargers and Inverters for Nuclear Power Generating Stations
- 690-1984 Standard for the Design and Installation of Cable Systems for Class 1E Circuits in Nuclear Power Generating Stations
- 741-1990 Standard Criteria for the Protection of Class 1E Power Systems and Equipment in Nuclear Power Generating Stations
- 765-1983 Standard for Preferred Power Supply for Nuclear Power Generating Stations
- 833-1988 Recommended Practice for the Protection of Electric Equipment in Nuclear Power Generating Stations from Water Hazards
- 802.1D-1990 Media Access Control (MAC) Bridges
- 802.3-1990 Carrier Sense Multiple Access with Collision Detection
- 934-1987 Standard Requirements for Replacement Parts for Class 1E Equipment in Nuclear Power Generating Stations
- 944-1986 Recommended Practice for the Application and Testing of Uninterruptible Power Supplies for Power Generating Stations
- 946-1985 Recommended Practice for the Design of Safety-Related DC Auxiliary Power Systems for Nuclear Power Generating Stations
- 1050-1989 Guide for Instrumentation and Control Equipment Grounding in Generating Stations

Insulated Power Cable Engineers Association (IPCEA)

- S-19-81 Rubber-insulated Wire and Cable for the Transmission and Distribution of Electrical Energy (NEMA Pub. No. WC3)
- P-32-382 Short Circuit Characteristics of Insulated Cable
- P-46-426 Power Cable Ampacities, Volume I - Copper Conductors
- P-54-440 Ampacities; Cables in Open-top Cable Trays
- S-61-402 Thermoplastic Insulated Wire and Cable for the Transmission and Distribution of Electrical Energy
- S66-524 Cross-linked Thermosetting Polyethylene-Insulated Wire and Cable for the Transmission and Distribution of Electrical Energy (NEMA Pub. No. WC7)
- S68-516 Ethylene-Propylene-Rubber-Insulated Wire and Cable for the Transmission and Distribution of Electrical Energy (NEMA Pub. No. WC8).

Miscellaneous

- EIA/TIA-568-1991 Commercial Building Telecommunications Wiring Standard
- ISO Open Systems Interconnection (OSI) Reference Model
- Standard Building Code Sections 1123, 1124, 2606.1

National Electrical Manufacturers Association (NEMA)

AB1-86	Molded Case Circuit Breakers and Molded Case Switches
AB3-84	Molded Case Circuit Breakers and Their Application
CC1	Electric Power Connectors for Substations
EI2	Instrument Transformers
ICS 1-88	General Standards for Industrial Controls and Systems
ICS 2-88	Industrial Control Devices, Controllers and Assemblies
ICS 4	Terminal Blocks for Industrial Use
II2	Electrical Indicating Instrument - Relays
IS 1.1	Enclosures for Industrial Controls and Systems
LA1	Surge Arresters
MG-1	Motors and Generators (ANSI C52.1)
PB 1-90	Panelboards
PE5-85	Utility Type Battery Chargers
PV 5	Constant Potential Type Electric Utility Semiconductor Static Inverter Battery Chargers
RP 1	Renewal Parts for Motors and Generators
SG 1	Electrical Power Connectors
SG3	Low Voltage Power Circuit Breakers
SG4	Alternating-Current High Voltage Circuit Breakers
SG5	Power Switchgear Assemblies
SG 6	Power Switching Equipment
SG 11	Coupling Capacitors, Coupling Capacitor Potential Devices and Line Traps
ST20-86	Dry Type Transformers for General Application
TR1	Transformers, Regulators, and Reactors
VE1	Metallic Cable Tray Systems
WC-5	Thermoplastic-Insulated Wire and Cable for the Transmission and Distribution of Electrical Energy
WC-7	Cross-Linked Thermo-setting Polyethylene Insulated Wire and Cable for the Transmission and Distribution of Electrical Energy
WC-8	Ethylene-Propylene Rubber-Insulated Wire and Cable for the Transmission and Distribution of Electrical Energy
WC51-86	Ampacities of Cables in Open-Top Cable Trays, Third Edition
107	Methods of Measurement of Radio Influence Voltage (RIV) of High Voltage Apparatus
210	Secondary Unit Substations
250	Enclosures for Electrical Equipment (1000V Maximum)
<u>National Fire Protection Association (NFPA)</u>	



- 30 Flammable and Combustible Liquids Code
- 37 Standard for the Installation and Use of Stationary Combustion Engines and Gas Turbines

70-1990 National Electrical Code (NEC)

72-1990 Standard for the Installation, Maintenance, and Use of Protective Signaling Systems

78-1989 Lightning Protection Code

101-1991 Code for Safety to Life from Fire in Buildings and Structures.

Underwriters Laboratories (UL)

- 1 UL Standard for Safety Flexible Metal Conduit, Eighth Edition
- 6 UL Standard for Safety Rigid Metal Conduit, Ninth Edition
- 67-88 UL Standard for Safety Electric Panelboards, Tenth Edition
- 94 UL Standard for Safety Test for Flammability of Plastic Materials for Parts in Devices and Appliances, Fourth Edition
- 96 UL Standard for Safety Lightning Protection Components, Third Edition
- 96A UL Standard for Safety Lightning Protection Systems, Master Labeled, Ninth Edition
- 360 UL Standard for Safety Liquid-Tight Flexible Steel Conduit, Third Edition
- 489-91 UL Standard for Safety Molded Case Circuit Breakers and Circuit Breaker Enclosures, Eighth Edition
- 508 UL Standard for Safety Industrial Control Equipment, Fifteenth Edition
- 651 UL Standard for Safety Schedule 40 and 80 Rigid Conduit, Fifth Edition
- 797 UL Standard for Safety Electrical Metallic Tubing, Fifth Edition
- 845-88 UL Standard for Safety Motor Control Centers, Third Edition
- 1008-89 UL Standard for Safety Automatic Transfer Switches, Fourth Edition
- 1242 UL Standard for Safety Intermediate Metal Conduit, First Edition

US Code of Federal Regulations (CFR)

- 10 CFR 50, January 1, 1991, "Domestic Licensing of Production and Utilization Facilities"
- 10 CFR 435, January 1, 1991, "Energy Conservation Voluntary Performance Standards for New Buildings; Mandatory for Federal Buildings"
- 29 CFR 1910 July 1, 1991, "Occupational Safety and Health Standard (OSHA)"

US Department of Energy (DOE)

- DOE 5300.3B Telecommunications: Communications Security
- DOE 5480.6 Safety of DOE-owned Nuclear Reactors
- DOE 5480.7 Fire Protection
- DOE 6430.1A General Design Criteria

US Department of Energy Nuclear Energy Programs

- NE C1-1T Instrumentation and Control Equipment Grounding and Shielding Practices



	Water-Cooled Nuclear Power Plants
RG 1.68.3	Preoperational Testing of Instrument and Control Air Systems
RG 1.70	Standard Format and Content of Safety Analysis Reports for Nuclear Power Plants
RG 1.73	Qualification Tests of Electric Valve Operators Installed Inside the Containment of Nuclear Power Plants
RG 1.75	Physical Independence of Electric Systems
RG 1.76	Design Basis Tornado for Nuclear Power Plants
RG 1.78	Assumptions for Evaluating the Habitability of a Nuclear Power Plant Control Room During a Postulated Hazardous Chemical Release
RG 1.79	Preoperational Testing of Emergency Core Cooling Systems for Pressurized Water Reactors
RG 1.89	Environmental Qualification of Certain Electric Equipment Important to Safety for Nuclear Power Plants
RG 1.93	Availability of Electric Power Sources
RG 1.97	Instrumentation for Light-Water-Cooled Nuclear Power Plants to Assess Plant and Environs Conditions During and Following an Accident
RG 1.100	Seismic Qualification of Electric Equipment for Nuclear Power Plants
RG 1.102	Flood Protection for Nuclear Power Plants
RG 1.106	Thermal Overload Protection for Electric Motors on Motor-Operated Valves
RG 1.108	Periodic Testing of Diesel Generators Used as On-Site Electric Systems at Nuclear Power Plants
RG 1.117	Tornado Design Classification
RG 1.118	Periodic Testing of Electric Power and Protection Systems
RG 1.120	Fire Protection Guidelines for Nuclear Power Plants
RG 1.128	Installation Design and Installation of Large Lead Storage Batteries for Nuclear Power Plants
RG 1.129	Maintenance, Testing and Replacement of Large Lead Storage Batteries for Nuclear Power Plants
RG 1.131	Qualification Tests of Electric Cables, Field Splices, and Connections for Light-Water-Cooled Nuclear Power Plants
RG 1.133	Loose-Part Detection Program for the Primary System of Light-Water-Cooled Reactors
RG 1.137	Fuel-Oil Systems for Standby Diesel Generators
RG 1.139	Guidance for Residual Heat Removal
RG 1.153	Criteria for Power, Instrumentation, and Control Portions of Safety Systems
RG 1.155	Station Blackout

RG 1.156 Environmental Qualification of Connection Assemblies for Nuclear Power  
Plants

RG 1.158 Qualification of Safety-Related Lead Storage Batteries for Nuclear Power  
Plants

NRC Standard Review Plan

BTP CMEB 9.5-1 Fire Protection Program (NUREG-0800)

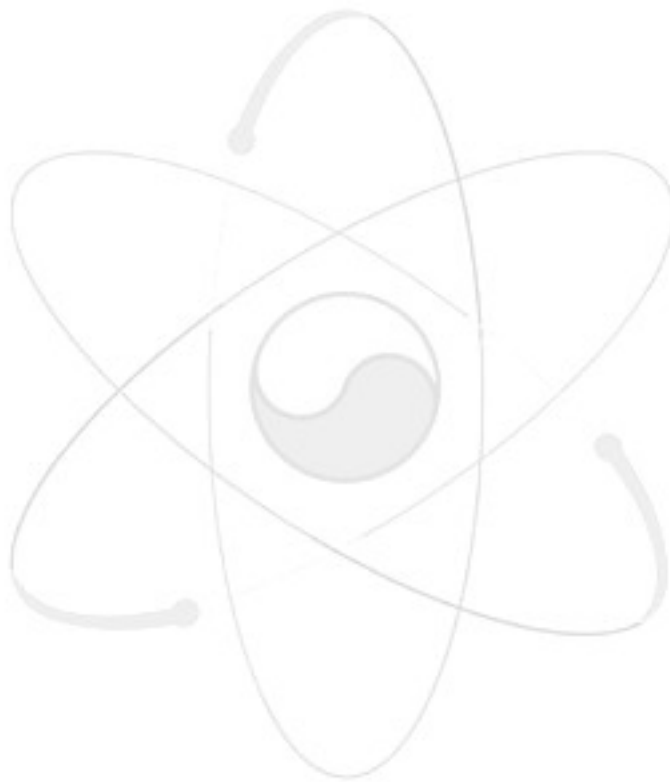

## 14. QUALITY ASSURANCE REQUIREMENTS

The design, procurement and construction activities will be governed by the project Q.A. program. The Q.A. level will be determined in accordance with the project classification procedure.

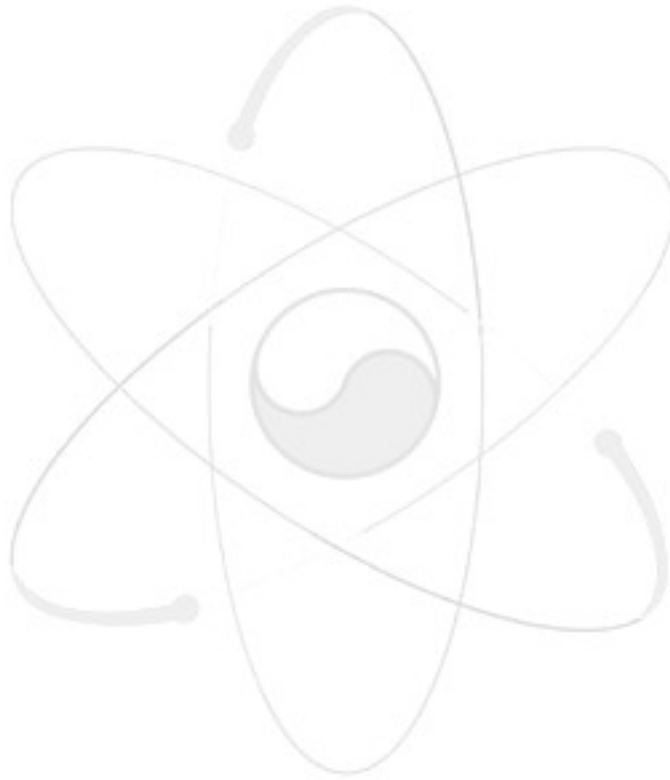

## 15. OTHER REQUIREMENTS

### 15.1. Standardization Requirements

The system shall be designed incorporation as much standard components as available for industrial use. Particularly, batteries, fuse holders and fuse, contacts, switches, cables, filters, etc, shall be standard industrial products.

### 15.2. Identification Requirements

All equipment shall be permanently and conspicuously marked and identified. Identification should not be place on removable covers or parts which might easily become interchanged. Tags, color codes, marking tapes or other suitable means are recommended for identification.

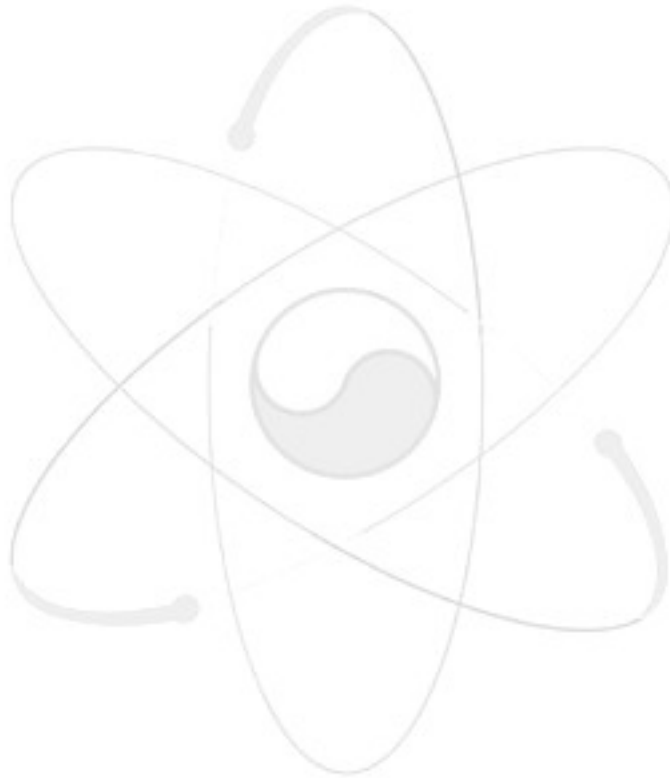

## 16. SUMMARY

Requirements for the design of electrical system - power distribution system- of a new research reactor were developed. Basic concepts were based on the HANARO's design. But the many requirements developed from the experience of operation and maintenance were added to improve the function and the availability. The requirements in this report will be implemented in the design or engineering stage of the electric system of the advanced research reactor.

The single line diagram for the typical design of the power distribution developed according to the design requirements in this report is the figure 1. The system has two off-site incoming feeders, one onsite standby power supply, and triplicated uninterruptible power supplies.

Requirements for the building service system - lighting, communication, fire detection and alarm, and grounding - will be developed in the next stage of the project.

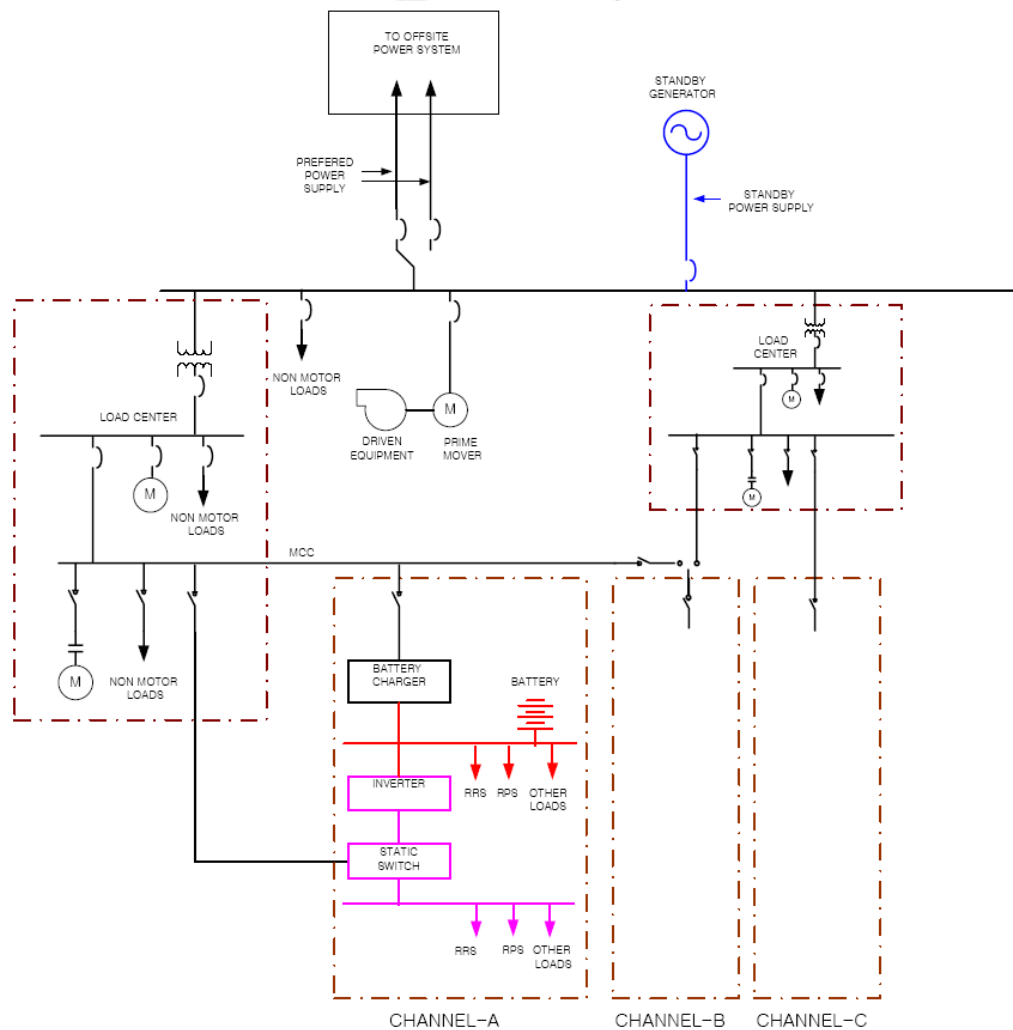
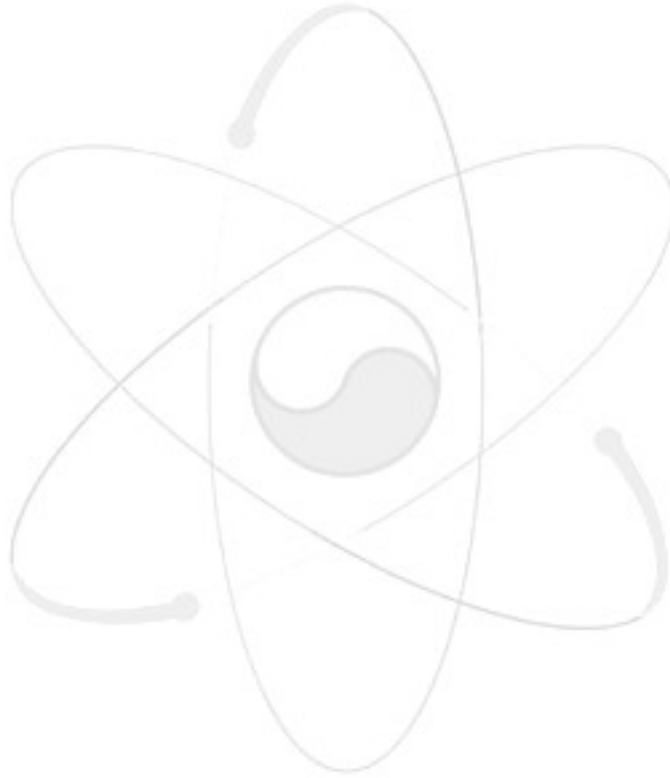

Figure 1 Single Line Diagram (Typical)

## 17. REFERENCES

- [1] The Korea Electric Power Industry Code, <http://www.electricity.or.kr>.
- [2] ANS Plant Electric Power and Communication Systems, ORNL/ANS/INT-26/S62/RA
- [3] H.S.Jung et al., Experiences on Design and Operation of HANARO(III) - Electrical, I&C System , KAERI / TR-2340/2002
- [4] Safety Analysis Report for HANARO, KAERI/TR-710/96, KAERI, 1996
- [5] H.S.Jung et al., Preliminary Conceptual Design for Electrical and I&C System of a New Research Reactor KAERI/TR-2659/2004, KAERI, 2004





서 지 정 보 양 식

서 지 정 보 양 식					
<b>수행기관보고서번호</b>		위탁기관보고서번호	표준보고서번호	INIS 주제코드	
KAERI/TR-2856/2004					
<b>제목/부제</b>		수출전략형연구로 전기 계통 설계 요건			
<b>연구책임자 및 부서명 (TR, AR인 경우 주저자)</b>		정환성 / 하나로운영부			
<b>연구자 및 부서명</b>		김형규, 김영기, 우종섭, 류정수 / 하나로운영부			
<b>출판지</b>	대전	<b>발행기관</b>	한국원자력연구소	<b>발행년</b>	2004.12.
<b>페이지</b>	35 p.	<b>도표</b>	있음( V ), 없음( )	<b>크기</b>	29x21 cm
<b>참고사항</b>					
<b>비밀여부</b>	공개(V ), 대외비( ), _ 급비밀		<b>보고서종류</b>	기술보고서	
<b>연구위탁기관</b>			<b>계약 번호</b>		
<b>초록 (15-20줄내외)</b>					
<p>하나로의 성공적인 건설,운영 기술을 바탕으로 새로운 연구용 원자로를 개발하고 있다. 현재 노심 및 핵연료를 설계 중에 있으며, 공정이나 전기, 계측제어분야는 개념 설계를 수행하고 있다.</p> <p>본 연구를 통하여 신형 연구용 원자로의 전기 계통 설계에 필요한 요건 들은 도출 하였다. 보조 계통인 전기 계통도 원자로 설계 기본 원칙인 안전성 향상, 신뢰도 향상, 경제성 확보등을 성취할 수 있도록 개념을 설정 하였다. 본 설계요건은 새로운 연구로의 고압 수전 계통, 저압 배전계통, 비상전원 계통 및 케이블 계통 설계에 기본이 될 것이다.</p>					
<b>주제명키워드 (10단어내외)</b>	하나로, 설계경험, 전기설계, 수전계통, 배전계통, 개념설계, 수출전략형연구로, 설계요건				

BIBLIOGRAPHIC INFORMATION SHEET					
<b>Performing Org. Report No.</b>		Sponsoring Org. Report No.		Standard Report No.	
KAERI/TR-2856 /2004					
Title/ Subtitle		Design Requirement for Electrical System of an Advanced Research Reactor			
Project Manager and Department (or Main author)		Hoan Sung, Jung / HANARO Management Div.			
Researcher and Department		H.K. Kim, Y.K. Kim, J.S.Wu, J.S. Ryu / HANARO Management Div.			
Publication Place	Daejeon	Publisher	KAERI	Publication Date	2004.12.
Page	35 p.	Fig. & Tab.	Yes( V ), No ( )	Size	29x21 cm.
Note					
Classified	Open(V ), Restricted( ), ___ Class Document		Report Type	Technical Report	
Sponsoring Org.				Contract No.	
Abstract(15-20 Lines)					
<p>An advanced research reactor is being designed since 2002 and the conceptual design has been completed this year for the several types of core. Also the fuel was designed for the potential cores. But the process system, the I&amp;C system, and the electrical system design are under pre-conceptual stage. The conceptual design for those systems will be developed in the next year.</p> <p>Design requirements for the electrical system set up to develop conceptual design. The same goals as reactor design - enhance safety, reliability, economy, were applied for the development of the requirements. Also the experience of HANARO design and operation was based on.</p> <p>The design requirements for the power distribution, standby power supply, and raceway system will be used for the conceptual design of electrical system.</p>					
Subject Keywords (About 10 words)		HANARO, design experience, electrical design, conceptual design, design requirement			