

LABORATORY PORTRAIT:
THE SACLAY NUCLEAR PHYSICS DIVISION
(CEA/DSM/DAPNIA/SPhN)

Nicolas ALAMANOS et Françoise AUGER

The Nuclear Physics Division (Service de Physique Nucléaire, SPhN) of DAPNIA at Saclay in France is part of the fundamental research divisions of the CEA (Commissariat à l'Energie Atomique). Its programs cover a broad range of topics in Nuclear Physics from low to high energies. They include the study of the structure and dynamics of the nucleus, the structure of the nucleon and the search for phase transitions of nuclear matter. SPhN also contributes to measurements and modeling of specific nuclear reactions related to nuclear waste transmutation. Furthermore, physicists apply their knowledge, competence and techniques to the development of innovative nuclear energy cycles, to the production of neutron and radioactive beams and to the decommissioning of nuclear installations. The research activities take place within strong national and international collaborations involving the academic world and enabling the selection and training of high quality students and post-doctoral researchers.

The structure of the nucleus

The objective of experiments in this area is to test and improve the descriptive and predictive power of nuclear structure models in the most extreme conditions with regards to nuclear isospin, angular momentum, mass and temperature. Most of these experiments concern very unstable nuclei for which new phenomena such as very diffuse nuclear surfaces, clustering, low-lying resonances or new magic shells appear which are not predicted by present models. The isospin dependence of the effective nucleon-nucleon force is a key ingredient of the models. One may expect that, along with other parameters of the effective force, such as the spin-orbit coupling or the pairing term, it will need to be readjusted for nuclei far from stability.

SPhN is involved in the study of the structure of light exotic nuclei such as ${}^6\text{-}8\text{He}$, ${}^{10\text{-}11}\text{C}$, ${}^{27}\text{Ne}$ and in the study of shape coexistence in Kr isotopes. The experiments are performed at GANIL with beams delivered by the SPIRAL or SISSI facilities. It is also involved in experiments at Jyväskylä (Finland) to obtain information on the spectroscopy of transfermium nuclei and especially on the structure of ${}^{251}\text{Md}$. Near-barrier and sub-barrier fusion of light unstable nuclei and their respective stable isotopes with ${}^{238}\text{U}$ targets are studied at Louvain La Neuve (Belgium). Among the most significant experimental results, one can mention the remarkable sensitivity of inelastic scattering to the halo structure of ${}^6\text{He}$, studies on the structure of ${}^8\text{He}$ (figure 1), the first experimental evidence for a shape isomer in N=Z nuclei (${}^{72}\text{Kr}$) supporting the predicted scenario of prolate-oblate shape coexistence in this mass region and, by combining conversion-electron and gamma-ray

spectroscopy, the first study of the structure of an odd transfermium nucleus ^{251}Md (figure 2)

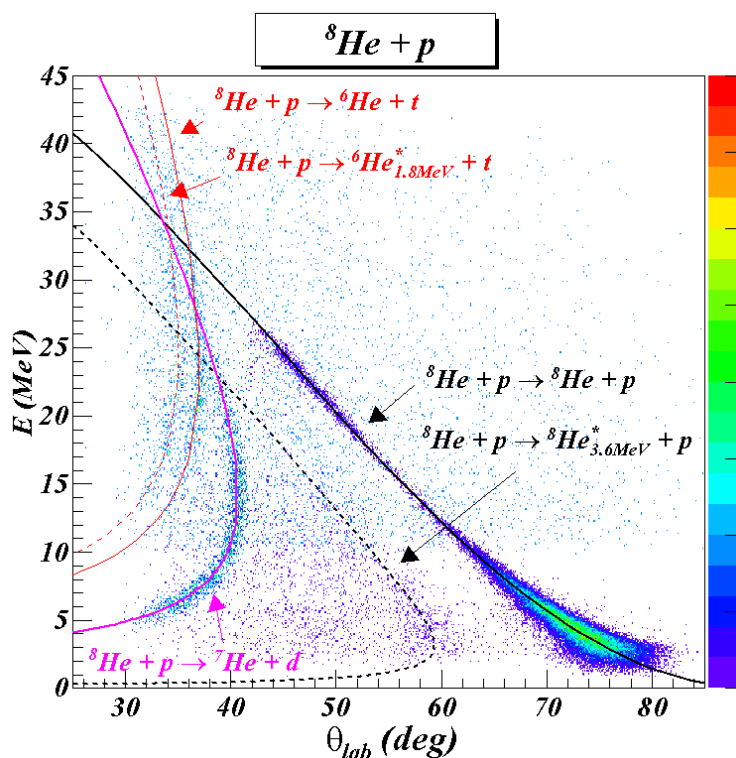
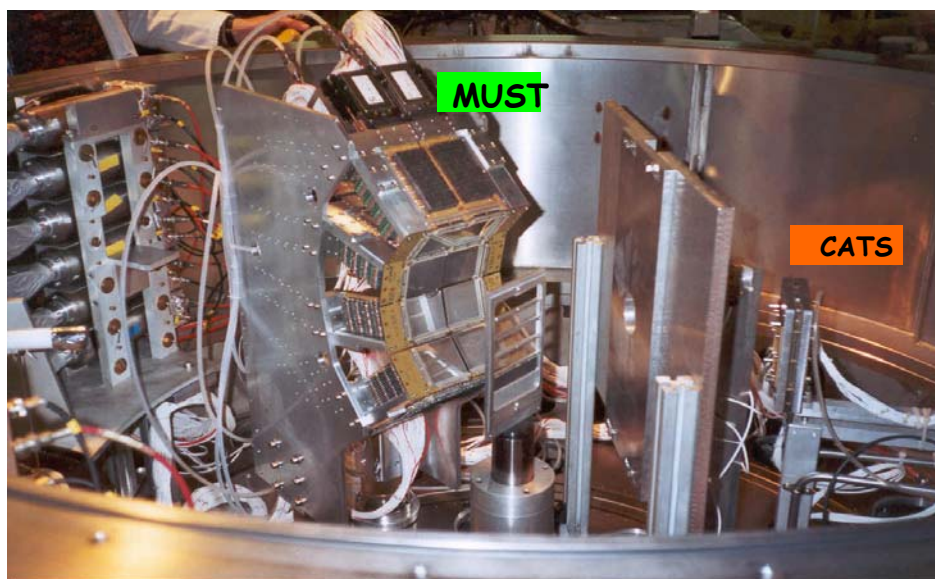

Figure 1. To investigate the structure of exotic nuclei with direct reactions in inverse kinematics, the MUST detector has been developed (collaboration IPN Orsay, SPhN and SPN Bruyères le Châtel). A typical experimental arrangement is presented (top). In particular, it was used with the Spiral ^8He beam at 15.6 MeV/nucleon impinging on proton target. A complete kinematical reconstruction of the induced direct reactions is achieved via the identification of the light recoiling particle in the MUST array in coincidence with the heavy reaction partner detected in a wall of plastic scintillator. Two beam tracking detectors, CATS developed by DAPNIA, are used to reconstruct event by event the trajectory of the incident particles. The energy versus scattering angle spectrum of the particles detected in MUST is shown (bottom). The kinematical loci indicate the elastic and inelastic scattering to the unbound first 2^+ excited state of ^8He (3.6 MeV) and the one- and two-nucleon transfer reactions $^8\text{He}(p,d)$, $^8\text{He}(p,t)$.

The experiments were realized with experimental devices constructed within the framework of national and international collaborations and with the participation of DAPNIA technical divisions. This encompasses participation in the construction of the silicon strip detector array MUST, of the segmented clover Ge detector EXOGAM, of the focal plane detection system of the VAMOS spectrometer and of the target chamber with a rotating target system dedicated to the study of the structure and production of heavy and super-heavy elements. SPbN is now participating in the development of experimental devices designed to measure with better efficiency, energy resolution and granularity recoil particles (MUST2) and gamma-rays (AGATA) produced in reactions induced by radioactive beams.

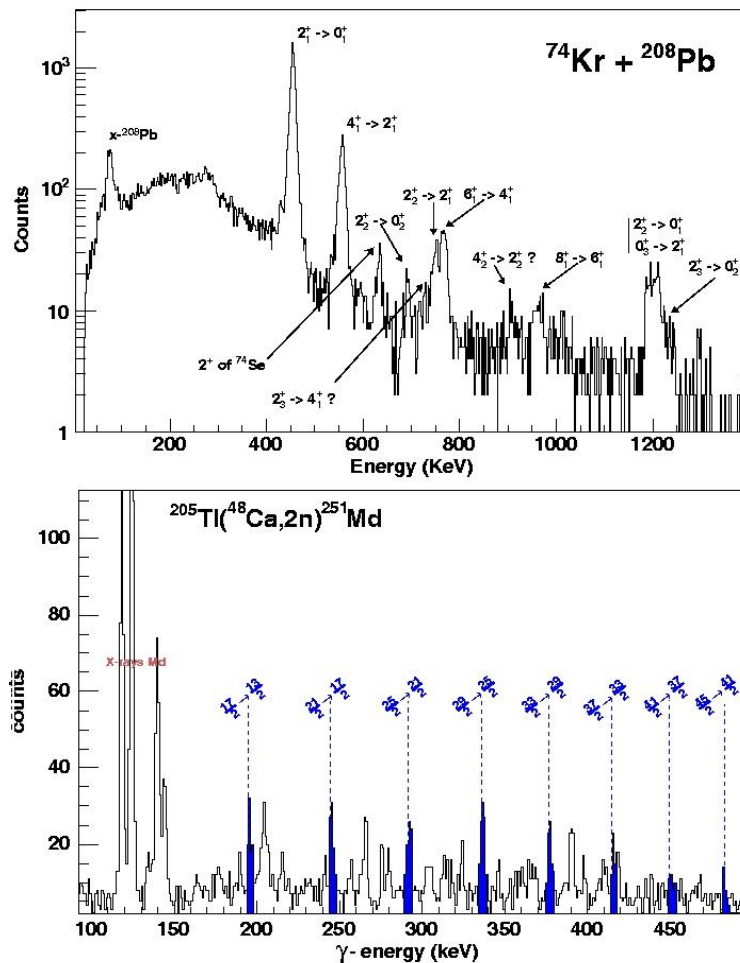

Figure 2. Top: Gamma-ray spectrum obtained in the Coulomb excitation of a 4.5MeV/u ^{74}Kr beam from SPIRAL taken with the EXOGAM spectrometer at GANIL. The intensities observed for the different states allow extracting static and transition quadrupole moments and confirm the supposed shape coexistence scenario. Bottom: First observation of a rotational band in an odd-mass Transfermium nucleus. The spectrum was taken with the Jurogam spectrometer at the University of Jyväskylä and obtained by tagging the gamma-rays with the alpha decay of ^{251}Md in the focal plane of the RITU gas-filled separator.

Nuclear structure physicists unanimously support the SPIRAL2 project, which aims to accelerate from 2009 radioactive beams produced by fission of uranium, and which will give access to beams of heavier nuclei than those obtained from the current SPIRAL facility. Medium and long-range plans encompass participation in the new GSI project R3B and in elaborating the physics case for the European EURISOL project as well as in participating in its design and construction.

Nuclear phase transitions

Heavy ion collisions offer the possibility to create in the laboratory nuclear matter under extreme conditions of pressure and temperature. The purpose of our activities in this domain is twofold: the study of the liquid-gas phase transition in nuclei at relatively low incident energies and the search for the quark-gluon plasma at very high energies.

At relatively low incident energies, SPhN is involved in studies of the dynamics of heavy-ion collisions which aim at obtaining information on the equation of state of nuclear matter and concomitantly on the liquid-gas phase transition. This is an ingredient of nuclear dynamics governing stellar processes such as supernova explosions. The main experimental tool for these studies is the 4π multi-particle INDRA detector, built with strong contributions from DAPNIA's technical divisions. One of the quantities of interest in these collisions is the excitation energy of the nuclei formed before any particle emission. An outstanding result in this domain is the direct measurement of the thermal excitation energy of the primary fragments produced in central collisions between 32 and 50 MeV/A. The experimental results are well reproduced by statistical multi-fragmentation models. These findings, combined with other experimental signatures, allow a better understanding of nuclear matter dynamics below 5 MeV/A excitation energy.

At high temperatures and/ or densities, QCD predicts a new form of matter, consisting of an extended volume of deconfined quarks, antiquarks and gluons called the quark-gluon plasma (QGP). The aim here is to study the properties of this plasma, which is thought to have existed a few microseconds after the Big Bang.

SPhN participates in this search. Among the signatures of the QGP one of the most promising is the colour screening of heavy resonances (J/ψ and Υ) formed by pairs of heavy quarks and antiquarks. We study these resonances through their decay into pairs of muons in two experiments: PHENIX with the accelerator RHIC at (BNL) and ALICE at the LHC (CERN). These two experiments use a dimuon spectrometer for the detection of resonances. SPhN has contributed to the electronics of one of the dimuon arms of the PHENIX experiment and is actively

participating in the construction of the dimuon arm for the ALICE experiment (figure 3).

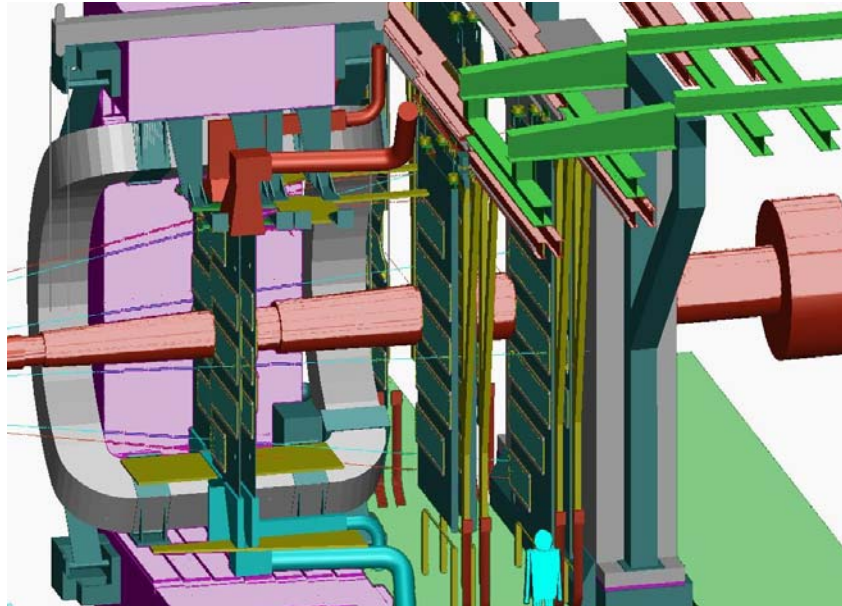

Figure 3. Large tracking stations are necessary to cover the solid angle of the ALICE dimuon spectrometer. The largest ones are visible on the picture, with station 3 located inside the dipole magnet and stations 4 and 5 downstream from it. They consist of cathode pad chambers arranged in slats on carbon fiber supports on both sides of the beam pipe and shielding. Station 3 is shown at its working position. Only the right halves of stations 4 and 5 are shown at their working positions. Dapnia/SPhN physicists and Dapnia technical divisions have been heavily involved in their design and prototype commissioning. Dapnia is responsible for building one fourth of them and for integrating all of them in the muon spectrometer.

PHENIX is currently taking data at RHIC at nucleon-nucleon collision energy of 200 GeV. Results on J/ψ production in Au-Au collisions will be available soon. A striking result obtained recently is the jet suppression observed at large transverse momentum. Indeed, data from the PHENIX detector show that the production rate of high- transverse momentum pions is suppressed in Au+Au collisions as compared to p+p or d+Au collisions. This result is compatible with suppression in a dense coloured medium and could be the signature for the QGP formation.

ALICE is an experiment at the LHC (CERN) which is in the course of preparation and which will take its first data in 2008 at an energy about 30 times higher than that of PHENIX (5.5 TeV).

It is anticipated that the existence of the QGP will be firmly established at RHIC and its detailed properties studied at ALICE/LHC in the forthcoming years.

The structure of the nucleon

SPhN is involved in two experimental programs both using electromagnetic probes, one to obtain information on the spin carried by the gluons in the proton (COMPASS at CERN) and the other to extract information on generalized parton distributions by means of deeply virtual Compton scattering (CLAS at JLAB).

The contributions of quarks ($\Delta\Sigma$) and gluons (ΔG) to the spin of the nucleon, are accessible by using a polarised lepton beam and a polarised nucleon target. Recent experiments at CERN (SMC) and at SLAC, with strong participation by SPhN, have established that the contribution of the quarks to the spin of the nucleon is small. These results have been complemented by the HERMES experiment at DESY and it is now widely accepted that the quark intrinsic spin contributes only a small fraction (20%-30%) to the total nucleon spin. These results agree with recent QCD calculations.

The main goal of the COMPASS experiment is the measurement of the gluon polarisation in the nucleon. DAPNIA has contributed to the COMPASS spectrometer by developing and building 12 micro-strip "micromegas" detectors ($40\times 40\text{cm}^2$) (figure 4) and 24 drift chambers ($120\times 120\text{cm}^2$). These detectors are placed in the zone of high particle flux, immediately behind the target. Data taken in 2002 and 2003 have been analysed. These data already provide competitive statistics for numerous channels: measurement of g_1 (better than SMC at small x), semi-inclusive scattering (already comparable to *Hermes*), coefficients of the ρ meson spin density matrix, polarisation of the Λ (as good as NOMAD) and $\bar{\Lambda}$ (much better than NOMAD). However, the main challenge remains the determination of the gluon polarisation $\Delta G/G$. At the recent international conferences SPIN04 in Trieste and BARYONS04 at Palaiseau, the first results on $\Delta G/G$ from high transverse momentum hadron pairs were presented.

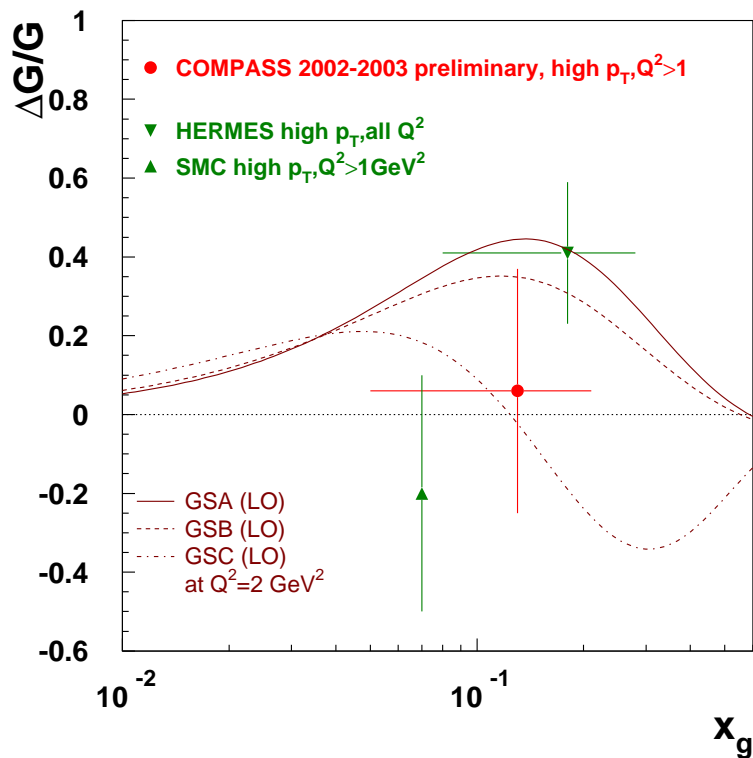
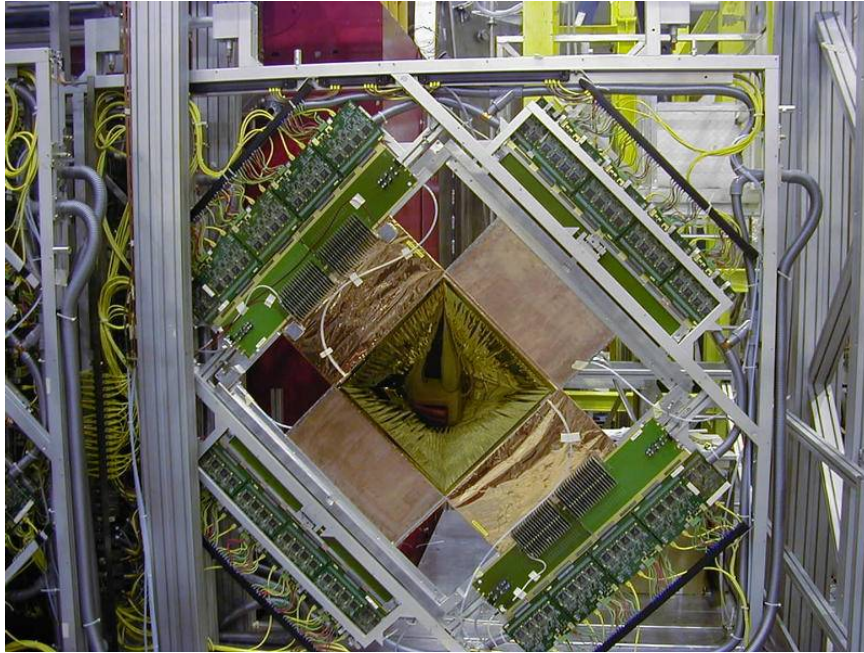

Figure 4. The COMPASS experiment at CERN has a broad physics program focused on the study of the spin structure of the nucleon and on hadron spectroscopy. The two-stage spectrometer is designed for high particle rates and high resolution tracking. The photo shows one of the Micromegas "doublets" consisting in two microstrip detectors oriented perpendicularly, with 1024 strips each covering a $40 \times 40 \text{ cm}^2$ active area (top). Data taking has started in 2002, and will last at least until 2010. The first COMPASS preliminary result on the gluon polarization $\Delta G/G$, measured at a momentum fraction of the gluon $x_g = 0.13$ has been obtained from high p_T hadron pair data taken in 2002 and 2003. It is compared to HERMES and SMC published results and to theoretical predictions obtained from fits to polarized deep inelastic data (bottom).

QCD also provides predictions for the transversity, which is the probability of measuring a quark with a spin orientation parallel to that of the nucleon spin when this is perpendicular to the incident beam. Transversity also manifests itself by a structure function which is a new aspect of the quark dynamics in the nucleon. In the years to come the COMPASS experiment will measure the transversity and bring information in this area which is essentially untouched experimentally.

The generalised parton distributions (GPD) allow an exploration of the three-dimensional structure of nucleons in terms of partons. The innovative aspect of these quantities is their sensitivity to correlations between partons, allowing for example, to connect them to the total angular momentum carried by the quarks or the gluons. Experimentally, the GPDs are accessible through exclusive hard reactions. Among these, the simplest process is deeply virtual Compton scattering (DVCS), $ep \rightarrow ep\gamma$. One of the first DVCS measurements was published by the CLAS collaboration at JLAB in 2002. Physicists from SPhN have contributed to the measurement of the spin asymmetry for the DVCS process at a beam energy of 4.2 GeV. New experiments are in preparation at JLAB using experimental equipment under construction at Saclay (figure 5). The first goal of these exploratory measurements is to validate the theoretical connection between DVCS and GPDs.

In parallel with these experimental activities, the three theorists of SPhN have focused their activities on the structure of the nucleon and baryon resonances. Subjects that are particularly studied are the GPDs, the form-factors of the nucleon and reactions for the electromagnetic production of photons and mesons in different kinematic regimes.

Today, there are good prospects for powerful electron facilities in the US, in particular at JLAB. It is therefore important to continue our investigations at JLAB in which, thanks to a future increase of the beam energy to 12 GeV, measurements of the GPDs will be carried out in a wider kinematic range from 2010 onwards. In parallel, a team from SPhN is studying the possibility of measuring DVCS with the COMPASS spectrometer at CERN starting also in 2010 in a complementary kinematical region.

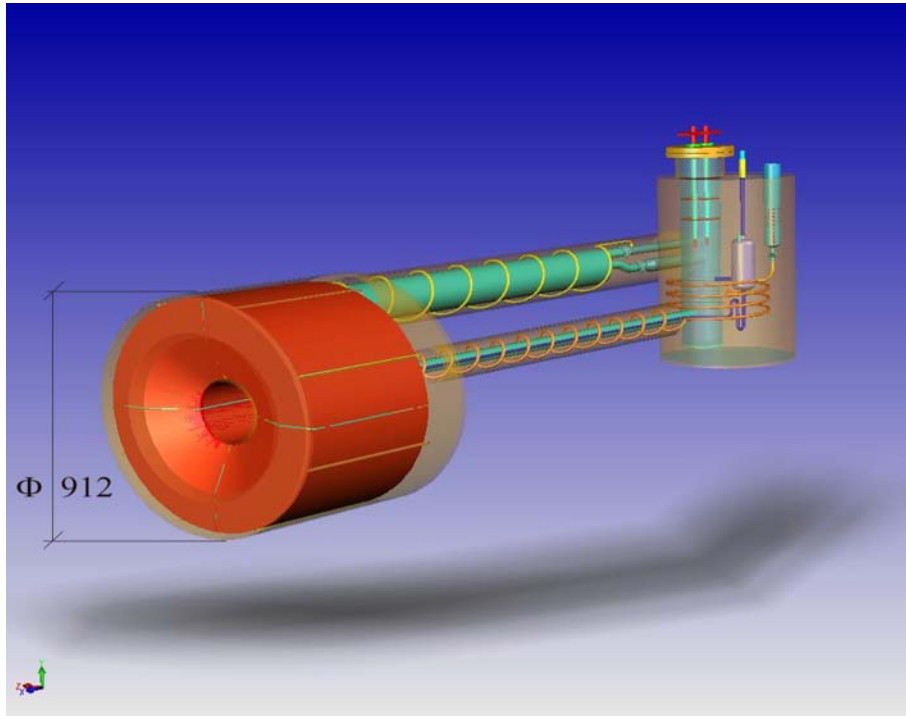

Figure 5. The CLAS/DVCS experiment, to run in the spring of 2005 at Jefferson Lab, will investigate over a large kinematical domain the applicability of the new concept of Generalized Parton Distributions (GPD). A group of SPhN physicists is part of the leading effort to assemble and run this experiment. A forward photon calorimeter is being added in the middle of the CLAS spectrometer, and DAPNIA provides the laser monitoring for the 424 lead-tungstate crystals. The necessary magnetic shield for this calorimeter is a superconducting two-coil solenoid (this figure), entirely built at DAPNIA with an original cryogenic design, together with its controls and safety system. This is to date the largest equipment to be inserted within CLAS.

Physics for nuclear energy

In the years to come fast neutron reactors will enable the exploitation of the considerable resources offered by uranium ^{238}U as well as by an eventual ^{232}Th fuel cycle. Nevertheless, the management of nuclear waste is an essential condition for the acceptance of nuclear energy by society. In order to progress in these areas and study new means of producing nuclear energy, the neutron production through spallation process should be carefully studied and precisely modeled. New sets of neutron induced cross-sections are also needed for many isotopes (especially those present in waste) under various types of reactor neutron fluxes. Our activities in this domain are focused along three major lines: spallation studies, neutron cross section measurements and application oriented modeling.

The goal of the spallation studies is to achieve a complete understanding of spallation reactions with experiments covering a wide range of channels. An SPhN group is participating in spallation residue cross-section measurements at the relativistic heavy ion facility of GSI (Darmstadt, Germany). A new experimental programme is now under

development (SPALLADIN) with the aim of performing more exclusive spallation measurements by measuring spallation residues and evaporated light particles in coincidence in order to obtain information on the de-excitation stage of the reaction.

These experimental studies are complemented by theoretical development of high-energy spallation models (INCL4). These models, once validated with a wide set of experimental data, are incorporated in high-energy transport codes such as LAHET3 or MCNPX and used to evaluate quantities relevant to ADS design (figure 6). It is foreseen that these studies will be continued at the planned R3B relativistic heavy ion facility at GSI and within the framework of the NUSTAR collaboration.

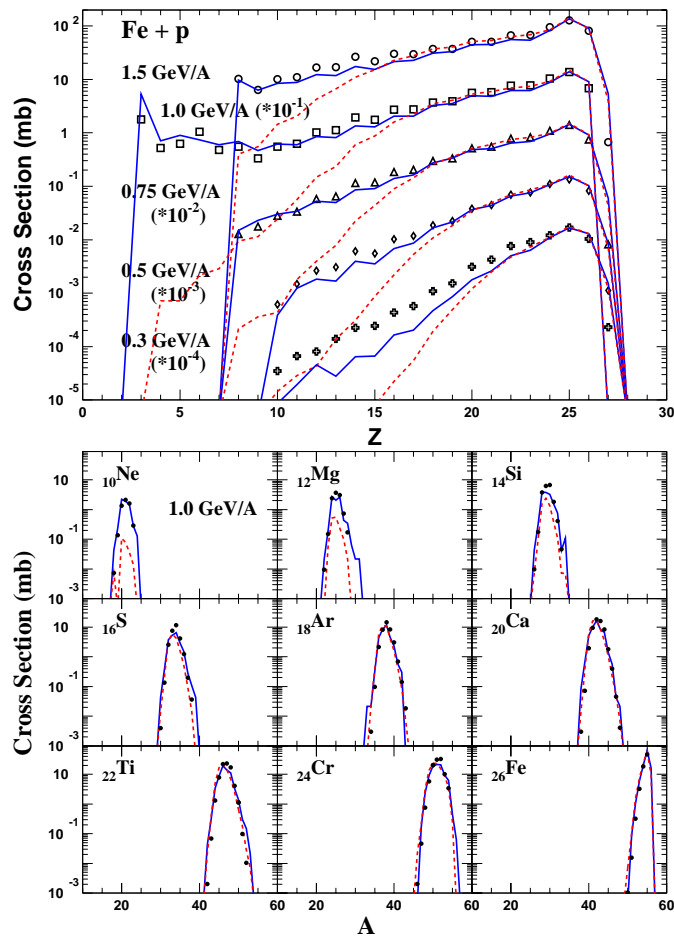

Figure 6. Mass distribution at several energies (top) and examples of isotopic distributions at 1 GeV (bottom) of spallation residues produced in $p+Fe$ reactions measured using the reverse kinematics technique with the Fragment Separator at GSI (collaboration SPhN - GSI - IN2P3 - Santiago de Compostella University). The experimental results are compared with calculations using the Intra-nuclear Cascade model, INCL4, developed by the group in collaboration with the University of Liège, followed by two different de-excitation models: the solid line is obtained with a standard evaporation while the dashed line comes from a de-excitation code in which the production of light fragments originates from an asymmetrical fission mode competing with classical evaporation. These results have been used to compute the impurity production in an Accelerator-Driven System window. Recoil velocities have also been measured and allow assessing of damage due to atom displacements in such a window.

In recent years, high-resolution neutron-induced reaction cross section measurements have gained much interest due to the development of new activities related to nuclear energy, such as the transmutation of nuclear waste, the thorium-based nuclear fuel cycle and ADS. These new applications have triggered a renewed interest in neutron-nucleus reactions, in particular for isotopes and energy regions that are essential for the development and design of these concepts.

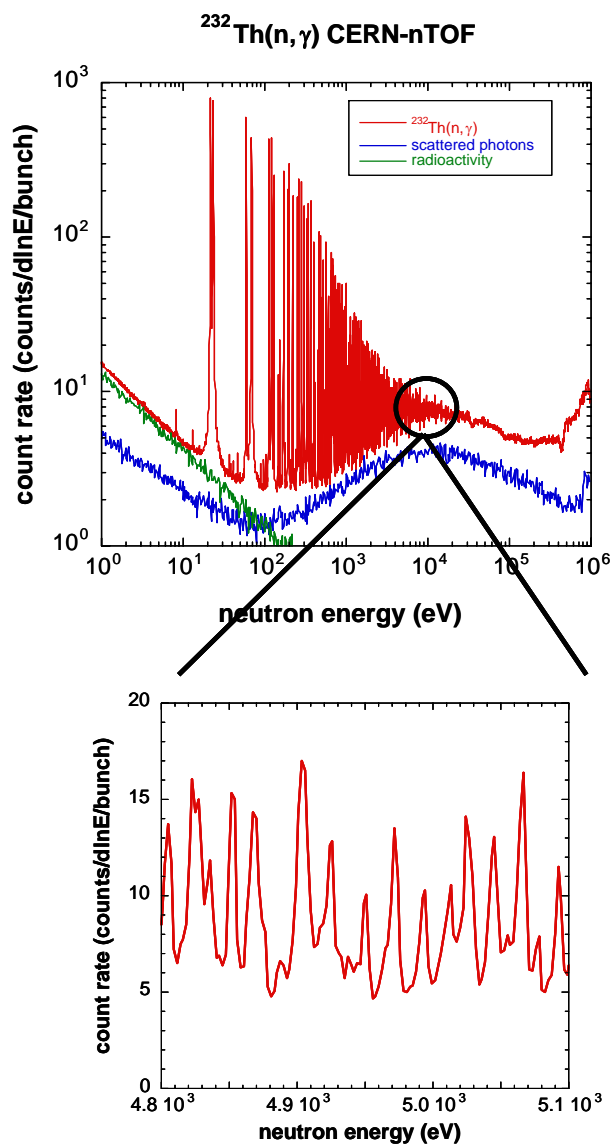

Figure 7. The n_TOF collaboration has recently built and exploited a new neutron time-of-flight facility at CERN in the frame of a shared cost RTD action of the Fifth EU Framework Program. Since the final commissioning, a scientific programme of measurements of neutron capture and fission cross sections of actinides, long lived fission fragments and other isotopes relevant for nuclear technology and nuclear astrophysics, has been scheduled in a first phase from 2001 to 2004. The figure shows an example of the count rate spectrum of the $^{232}\text{Th}(n,\gamma)$ capture cross section experiment at n_TOF at CERN, measured with neutron insensitive deuterated benzene gamma-ray detectors. The programme for a second phase of measurements at CERN is currently in preparation.

SPhN has been involved from the beginning in the construction of the new time-of-flight facility nToF at CERN. The strength of nToF lies in its very high instantaneous neutron flux making the nToF facility particularly suitable for measurements with a low signal to background ratio, as in the case of radioactive or low mass samples. SPhN is also involved in the neutron time-of-flight facility Gelina at Geel for carrying out both neutron capture and transmission measurements.

In addition to the energy-dependent cross section measurements, integral neutron-induced cross sections are investigated by SPhN groups within the Mini-Inca project. This project aims at determining experimentally the optimal conditions for the transmutation of minor actinides in high intensity, highly thermalised neutron fluxes.

Furthermore, SPhN is involved in the measurement of neutron flux and actinide incineration rates inside the liquid lead-bismuth spallation target within the European MEGAPIE experiment (PSI, Switzerland). The MEGAPIE project is the first experimental demonstration of a 1 MW liquid Pb-Bi spallation target coupled to a high intensity (1.5 mA) proton accelerator. This experiment will take place in 2006.

In parallel with the above experimental activities, some fundamental and applied modelling activities have been developed. This expertise was developed to simulate and characterize neutron fluxes inside the experimental Mini-Inca channels. It is now applied to calculations of innovative nuclear systems for nuclear waste transmutation, intensive neutron sources based on spallation and photonuclear reactions, radioactive nuclear beam production scenarios, characterization of nuclear waste barrels, production of neutron-rich fission fragments, etc., in close cooperation with the LANL (US).

These modelling tools are based on a Monte Carlo technique allowing realistic geometry and material specifications in 3D. When available, the evaluated data libraries are used for multi-particle-nucleus interactions and transport calculations. Otherwise recent nuclear models are applied to simulate different processes of interest including time-dependent evolution of nuclear fuel and/or irradiation/production targets. These activities serve as direct evidence of the link between knowledge of fundamental nuclear physics and society related problems.

This expertise led us to undertake modelling related to the decommissioning of nuclear installations such as particle accelerators and research or industrial nuclear reactors, in collaboration with DAPNIA/SDA. We expect these activities to be pursued in the future within the framework of collaboration with the valorisation DAPNIA/cell. Finally, among emerging activities we would like to quote participation

in Monte Carlo simulations of emission tomography for medical diagnostic and treatment purposes.

The Service de Physique Nucléaire is part of the national basic research community and contributes to the excellence of French research while actively participating in the fundamental missions of the Commissariat à l'énergie atomique.